



# Electronic Roller Shutter Belt Winder superrollo GW240 / GW245

Translation of the Original Operating and Assembly Manual



Item No.:

superrollo GW240

SR10240

superrollo GW245 \*

SR10245

\* Mini belt



## Dear Customer,

With your purchase of a roller shutter belt winder **superrollo GW240 / GW245**, you have chosen a quality product manufactured by superrollo. Thank you for the trust you have placed in us.

i	Dear Customer, .....	2	13.	Introduction to opening and setting the functions .....	30
1.	These instructions.....	4	14.	Initial commissioning with the help of the installation wizard.....	31
1.1	Application of this manual .....	4	15.	Manual operation.....	35
2.	Hazard symbols .....	4	16.	Description of the functions and setting options in the main menu .....	36
2.1	Levels of danger and signal words.....	5	16.1	Switching automatic mode on/off .....	37
2.2	Symbols and depictions used .....	5	16.2	Setting the switching times (opening and closing times).....	38
2.3	Technical Term - Definition.....	6	16.3	Setting the automatic dusk function.....	40
3.	Included in delivery .....	7	16.4	Setting the automatic solar function.....	42
4.	Overview of the superrollo GW240 / GW245.....	8	16.5	Setting the end points .....	45
4.1	Operating buttons.....	9	16.6	Set time and date.....	46
4.2	The display and its symbols .....	10	17.	Erase all settings, software reset .....	47
4.3	The standard display and the main menu.....	11	18.	Removing the superrollo GW240 / GW245 (e.g. in the event of a move) .....	48
5.	Functional description .....	12	19.	Removing the belt in the event of unit failure .....	50
5.1	Description of the safety functions.....	13	20.	What to do if... ? .....	51
5.2	Conduct in the event of power failure .....	14	21.	Information about maintenance and care of your equipment.....	53
6.	Technical Specifications .....	15	22.	Tractive force diagram.....	54
6.1	Dimensions .....	16	23.	Factory Settings.....	55
6.2	Permissible roller shutter belts .....	17	24.	CE Mark and EC Declaration of Conformity .....	56
7.	Safety instructions .....	18	25.	Accessories.....	57
7.1	Intended use.....	19	26.	Warranty conditions.....	58
7.2	Improper use .....	20			
8.	Safety instructions for the installation.....	21			
8.1	You will require the following tools .....	21			
9.	Preparation for installation .....	22			
10.	Mounting the wall bracket .....	24			
11.	Drawing in and fastening the belt .....	26			
12.	Mounting the superrollo GW240 / GW245.....	28			

## **i** 1. These instructions...

...describes how to install, connect the electrical system and operate your roller shutter belt winder superrollo GW240/GW245.

### **i** 1.1 Application of this manual

- ◆ Before you begin, please read this manual through completely and follow all the safety instructions.
- ◆ This manual is a component of the product. Please store it in an easily accessible place.
- ◆ When passing the superrollo GW240/GW245 on to a third party, this manual must be passed on as well.
- ◆ Damage resulting from non-compliance with this manual and safety instructions will void the guarantee. We shall assume no liability for any consequential damage.

## **i** 2. Hazard symbols

The following hazard symbols are used in this instruction manual:



**Danger of fatal electric shock**



**Danger area / dangerous situation**

## i 2.1 Levels of danger and signal words

### DANGER!

This hazard will result in serious injury or death if not avoided.

### WARNING!

This hazard may result in serious injury or death if not avoided.

### CAUTION!

This hazard may result in minor or moderate injury if not avoided.

### ATTENTION!

This hazard may lead to property damage.

## i 2.2 Symbols and depictions used

Depiction	Description
1.	Steps to be taken
2.	
◆	Itemisation
(1) or a)	List
	Please read the respective manual



further useful information



Flashing menu icon and setting parameters have a grey background.



Information about opening the menu and setting the parameters can be found on page 30.

### DIN EN 13659

*"Shutters and external Venetian blinds - Performance requirements including safety."*

- ◆ This standard determines the performance requirements that externally attached shutters and blinds must fulfil. It also contains significant hazards with regard to the design, transportation, installation, operation and maintenance of these shutters and blinds.

#### Blinds

- ◆ Roller shutters

#### Obstacle detection

- ◆ If the roller shutters hit an obstacle in the DOWN (▼) direction, the superrollo GW240/GW245 is switched off, see page 13.

#### Overload cut-off

- ◆ If the drive jams in the UP (▲) direction (for example, due to ice), the superrollo GW240/GW245 is switched off, see page 13.

#### End points

- ◆ An end point is defined and set for each running direction of the roller shutter. Once this point has been reached, the superrollo GW240/GW245 switches off and the roller shutter stops.

#### Running Time Limit - Transient Operation (KB)

- ◆ The roller shutter belt winder superrollo GW240/GW245 is not designed for continuous operation. Transient operation defined the maximum permissible running time, see page 15/ 18.

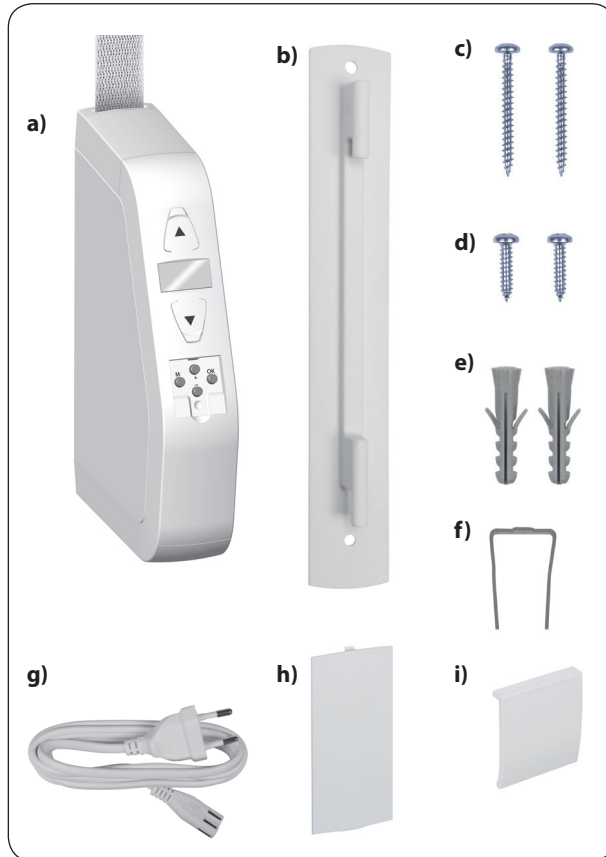

### Included in delivery

- a) 1 x superrollo GW240 or  
1 x superrollo GW245
- b) 1 x Wall bracket
- c) 2 x Assembly screws (4 x 40 mm)
- d) 2 x Assembly screws (4.2 x 19 mm)
- e) 2 x Wall plugs (S6 x 30 mm)
- f) 1 x Disengaging bracket
- g) 1 x Connecting cable with Euro plug
- h) 1 x Reel compartment cover
- i) 1 x Cover plate
- j) 1 x Instruction manual (not illustrated)

### After unpacking please check and compare...

the contents of the package with the above specified.

### Check the details on the type plate

Check that the voltage / frequency on the type plate corresponds to the local mains conditions.





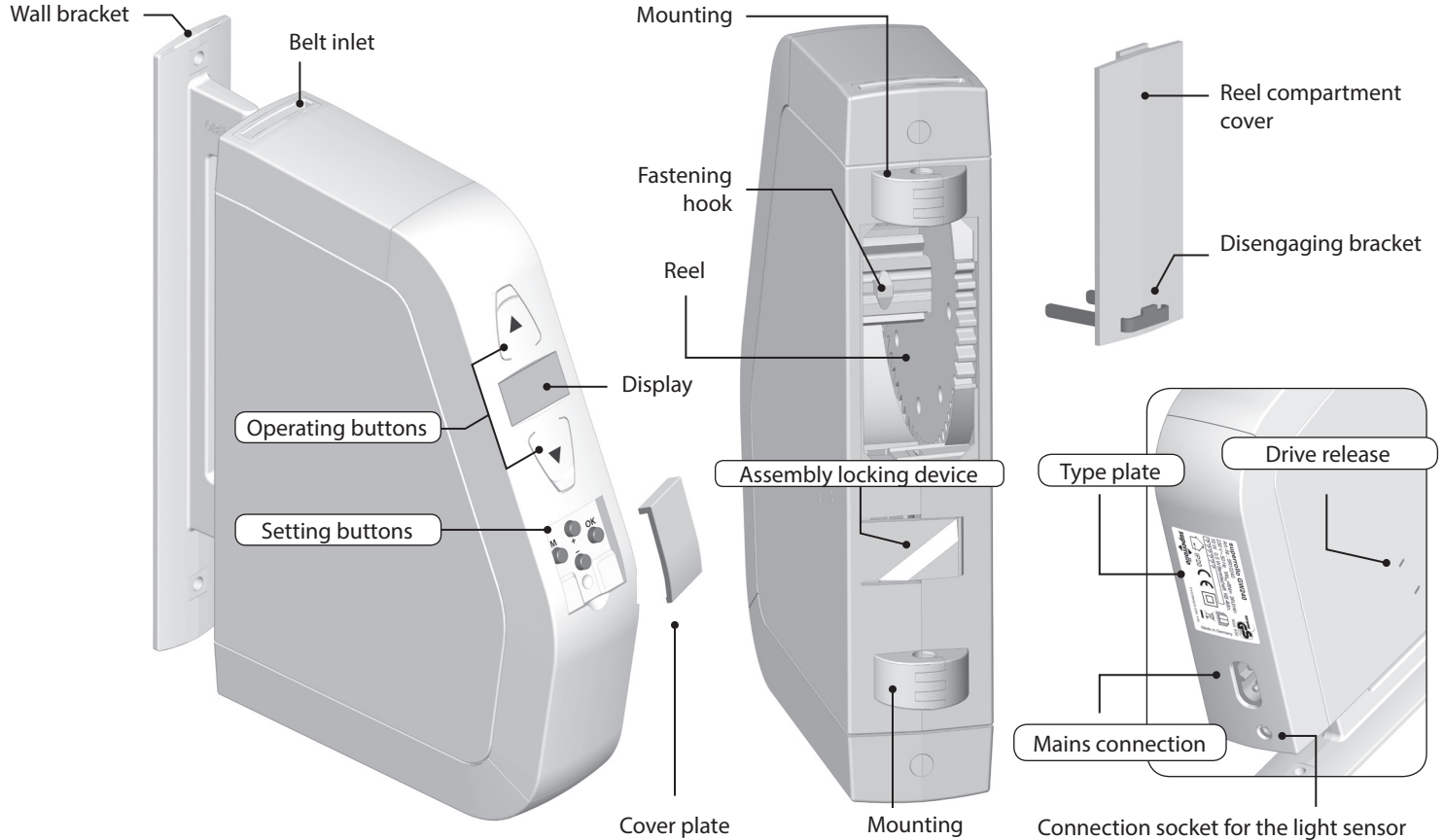

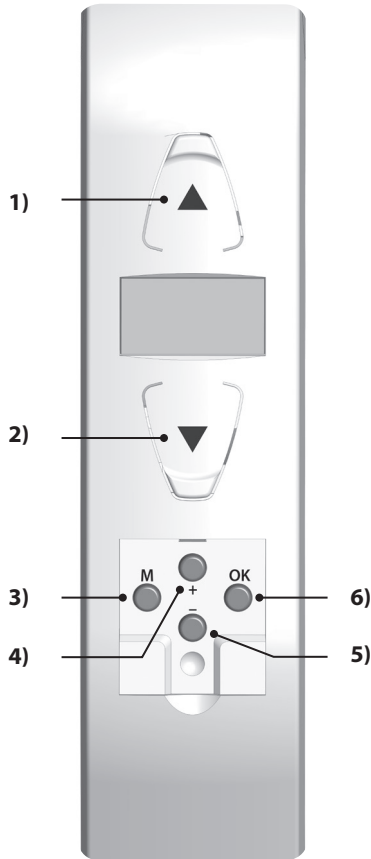

## 4. Overview of the superrollo GW240 / GW245







Pos.	Symbol	Description
1)		<b>Up / Stop button</b> <ul style="list-style-type: none"> <li>◆ The roller shutter travels upwards</li> <li>◆ The roller shutter stops</li> </ul>
2)		<b>Down / Stop button</b> <ul style="list-style-type: none"> <li>◆ The roller shutter travels downwards</li> <li>◆ The roller shutter stops</li> </ul>
3)		<b>Menu button</b> <ul style="list-style-type: none"> <li>◆ Call up the main menu</li> <li>◆ Back to previous menu or standard display</li> </ul>
4)		<b>Plus button / minus button</b> <ul style="list-style-type: none"> <li>◆ Selecting a menu in the main menu</li> <li>◆ Setting of parameters (more / less) <ul style="list-style-type: none"> <li>● short press = gradual setting</li> <li>● long press = fast setting</li> </ul> </li> <li>◆ Switch functions on / off</li> </ul>
5)		
6)		<b>OK button</b> <ul style="list-style-type: none"> <li>◆ Confirms and opens the selected menu</li> <li>◆ Confirm and save entry</li> <li>◆ Continue to next entry</li> </ul>

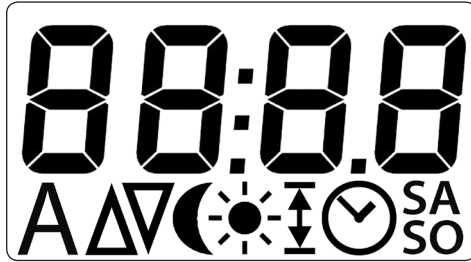

Pos.	Symbol	Description
1)	88:88	Time / setting parameters
2)	A	Switching automatic mode on/off
3)	△▽	Direction of travel - up / down
		Switching times (opening / closing time)
4)	☾	Automatic dusk function
5)	☀	Automatic solar function
6)	↑↓	Setting the end points
7)	🕒	Setting the time / date
8)	SA SO	Setting the weekend switching times

#### The standard display (see example)



Displays the time, no automatic functions are active.



Displays the time and the activated automatic timer.



Manual operation is only possible from the standard display.

#### The main menu



Enables display and selection of the individual functions and menus.

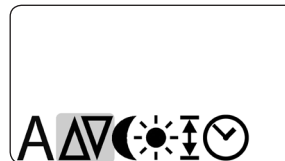

The selected menu flashes, e.g. the switching times.



Manual operation is not possible from the main menu.

- ◆ No automatic switching commands will be executed during the configuration process.
- ◆ If no button is pressed within 60 seconds, the display automatically changes back to the standard display.

The superrollo GW240 / GW245 is an electric roller shutter belt winder designed for use inside. The unit is installed as a surface-mounted device.

The power supply is provided via the enclosed connecting cable with a mains plug and a small appliances plug.

### Features and control options:

- ◆ Operational demonstrator
- ◆ Manual operation
- ◆ Switching automatic mode on/off
- ◆ Four switching times, with a separate switching time for  
UP (▲) and DOWN (▼) for:
  - Monday to Friday
  - Saturday and Sunday
- ◆ Automatic solar function (with light sensor)
- ◆ Automatic dusk function (with light sensor)
- ◆ Automatic summer/winter time - changeover
- ◆ End point setting
- ◆ Permanent storage of the settings
- ◆ Obstacle detection
- ◆ Overload cut-off
- ◆ Resetting to the default factory settings (Reset)

### Obstacle detection

The movement of the belt is monitored. If the roller shutters hit an obstacle in the DOWN (▼) direction, the belt will stop moving and the superrollo GW240 / GW245 is switched off.



Once the system has switched off, it is not possible to directly operate the drive in the same direction.

- ◆ First, run the belt winder back in the opposite direction and remove any possible obstacle.
- ◆ Then it is possible to operate the drive in the original direction again.



**There is a risk of injury if the obstacle detection is not working.**

- ◆ The belt must be wound on as evenly as possible to ensure safe and correct functioning of the obstacle detection function.
- ◆ Please ensure that the belt winds as straight and evenly as possible into the device during its subsequent cycle after the obstacle detection system has triggered.

### Overload cut-off

**The superrollo GW240 / GW245 is equipped with an overload cut-off system.**

If the drive jams in the UP (▲) direction (for example, due to ice), the superrollo GW240 / GW245 is switched off.

- ◆ First remove the cause of the overload.
- ◆ Then the superrollo GW240 / GW245 is fully operational again in both directions.

After a power failure the time flashes in the display and the installation wizard is active.

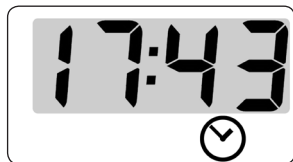

### Time and date after a power failure

The date and time stop with a power failure and need to be reset with the installation wizard, see page 32.

### Data retention following a power failure

All settings are permanently saved. The configured switching times are retained even following extended power failure.

**Power supply**

Supply voltage:	230 V ~ / 50 Hz
Nominal power:	70 W
Consumption:	Standby: < 0.5 W

**Mechanical capacity**

Nominal torque:	8 Nm
Maximum speed:	36 rpm
Maximum tractive force:	30 kg, see page 54 / Tractive force diagram
End tractive force:	13 kg

**Operating conditions**

Transient operation (KB):	4 minutes (maximum running time)
Protection class:	II
Protection type:	IP20 (only for use in dry rooms)
Setting ranges:	
- Automatic solar function	2,000 to 20,000 Lux
- Automatic dusk control	2 to 5 Lux

**Operating conditions**

Number of switching times:	4 (up and down)
Mains connecting cable:	2 x 0.75 mm <sup>2</sup> (H03VVH2-F)
Permissible ambient temperature:	0 °C to +40°C
Sound pressure level (LpA):	≤ 70 dB(A)



## 6.1 Dimensions

EN

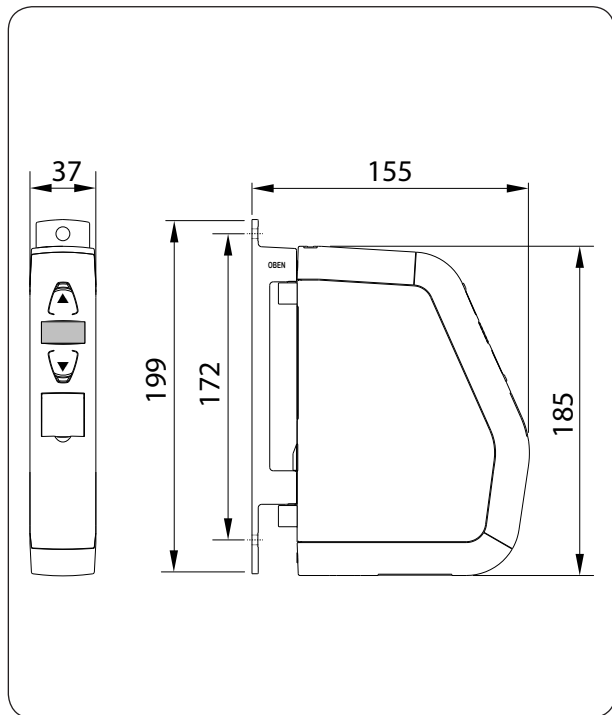

All dimensions in mm

superrollo GW240 / GW245  
Item no.: SR10240 / SR10245



**⚠ ATTENTION!**

**The superrollo GW240 / GW245 may be damaged if excessively long belts are used.**

Only use belts of the permissible lengths.



The specifications are intended for guidance only and apply to an ideal installation situation.

The actual values may vary due to local conditions.

**Table 1: Permissible roller shutter belts**

<b>superrollo:</b> Item No.:		<b>GW245 (Mini Belt)</b> SR10245	<b>GW240</b> SR10240
<b>Belt width:</b>	<b>Belt thickness</b>	<b>Maximum belt length</b>	
15 mm (Mini-belt)	1.0 mm	5 m	
23 mm (Standard belt)	1.0 mm		5 m
	1.3 mm		4 m
	1.5 mm		3.4 m

**Table 2: Permissible shutter surface area (m<sup>2</sup>)**

<b>Roller shutter type:</b>	<b>Weight/m<sup>2</sup></b>	<b>Permissible shutter surface area (m<sup>2</sup>)</b>	
Plastic roller shutters	(4.5 kg/m <sup>2</sup> )	Approx. 5 m <sup>2</sup>	Approx. 5 m <sup>2</sup>
Aluminium and wooden roller shutters	(10.0 kg/m <sup>2</sup> )	Approx. 2.5 m <sup>2</sup>	Approx. 2.5 m <sup>2</sup>



**The use of defective equipment can lead to personal injury and damage to property (electric shocks, short circuiting).**

- ◆ Never use defective or damaged equipment.
- ◆ Check the superrollo GW240/GW245 and the provided mains cable beforehand for damage.
- ◆ Should you discover damage to the equipment, please consult our customer service department (see page 60).



**Incorrect use leads to an increased risk of injury.**

- ◆ Train all personnel to use the superrollo GW240/GW245 safely.
- ◆ This device may be used by children from 8 years of age upwards as well as by persons with reduced physical, sensory or mental capacities or with lack of experience and knowledge if they are supervised or have been instructed on how to use the device safely and if they understand what dangers may result from this.
- ◆ Children must not play with the device. Cleaning and user maintenance may not be carried out by children without supervision.

- ◆ Watch the moving roller shutters whilst carrying out the settings and during normal operation, and keep other people away from the area to avoid injury in the event the shutters suddenly slip.
- ◆ Carry out all cleaning work on the roller shutters whilst the device is disconnected from the mains power.

**The mains socket and plug must be easily accessible at all times.**



**Exceeding the maximum permissible running time (KB) may overload and damage the superrollo GW240/GW245.**

- ◆ The maximum permissible running time for a cycle may not be exceeded when the equipment is in operation. For this reason, the superrollo GW240/GW245 has an **automatic running time limit (KB)** of four minutes.
- ◆ If the running time limit is triggered then the following error message will appear:





## 7. Safety instructions

EN

- ◆ If the running time limit is triggered, then the superrollo GW240 / GW245 must be left for at least 12 minutes to cool down.



During the cooling period the superrollo GW240 / GW245 may not be used and the temperature is displayed for as long as is necessary.

- ◆ Full operational availability is re-established after approx. one hour.

According to DIN EN 13659, it is necessary to determine that the movement conditions for the shutters are maintained in accordance with EN 12045.

- ◆ The displacement must be of at least 40 mm on the lower edge in the rolled-out position with a force of 150 N in the upwards direction.
- ◆ In doing so, it must be ensured that the extending speed of the shutters for the final 0.4 m is less than 0.15 m/s.



### 7.1 Intended use

Only use the superrollo GW240 / GW245 for opening and closing roller shutters with a permissible belt.



Mechanical locks of any kind are not suitable for automated operation with this device.

#### **Only use the manufacturer's original spare parts.**

- ◆ By doing so, you avoid risk of malfunctions and damage to your superrollo GW240 / GW245.
- ◆ As the manufacturer, we provide no guarantee for the use of third-party components and accept no liability for consequential damage resulting from such.
- ◆ All repairs to the superrollo GW240 / GW245 must be undertaken by authorised customer service personnel.



## 7.1 Intended use

### Operating conditions

- ◆ Only operate the superrollo GW240 / GW245 in dry rooms.
- ◆ An easily accessible 230 V/50 Hz mains socket must be available at the installation site.
- ◆ The roller shutters must run up and down smoothly and should not stick.
- ◆ The mounting surface for the superrollo GW240 / GW245 must be flat.



## 7.2 Improper use

Using the superrollo GW240 / GW245 for purposes other than previously mentioned is impermissible.



**There is a risk to life caused through short circuiting and electric shocks if the superrollo GW240 / GW245 is used outside.**

- ◆ Never install or operate the superrollo GW240 / GW245 outside.

## i 8. Safety instructions for the installation



**Poor routing of the belt can cause the belt to fail and leads to unnecessary loads on the superrollo GW240 / GW245.**

- ◆ Install the belt winder so that the belt runs as straight as possible into the device, in order to avoid unnecessary friction and wear.



**Incorrect installation can lead to property damage.**

- ◆ Strong forces are exerted during operation of the system which require secure installation on a firm base.

## i 8.1 You will require the following tools

- ◆ Screwdriver (cross recessed head)
- ◆ Scissors
- ◆ Carpenter's gauge or measuring tape
- ◆ Pen
- ◆ A drilling machine and a 6 mm masonry drill, if new mounting holes need to be drilled.

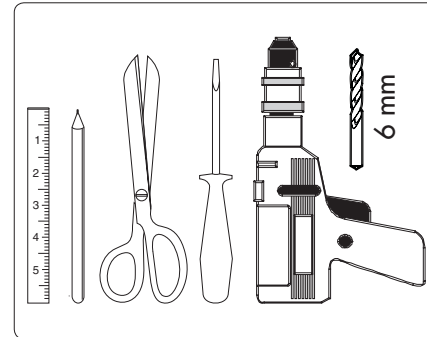

1. Take measurements. Check that there is sufficient space for the superrollo GW240/GW245.
2. Remove the old belt winder, if you are carrying out a conversion to an existing roller shutter system.
  - 2.1 Let the roller shutter move fully down, until the slats are completely closed.
  - 2.2 Remove the old belt winder and unreel the belt.

**⚠ CAUTION!**

**There is a risk of injury from the pre-tensioned springs on the old belt winder.**

- ◆ The spring unit of the old belt winder may suddenly recoil when it is removed.
- ◆ Hold the spring unit firmly when loosening the belt and allow it to recoil slowly until the spring unit has completely unwound.

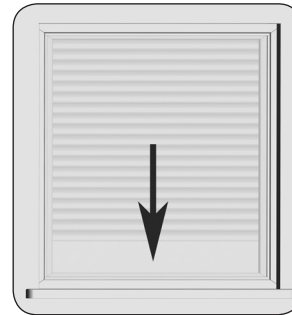

## i 9. Preparation for installation

### 3. Prepare the belt.

3.1 Cut the belt off approx. 20 cm under the mounting position.

3.2 Fold the end of the belt over by approx. 2 cm and cut a short slit in the centre. This enables you to subsequently hook the belt onto the reel.

#### Recommendation

The belt must run as straight and freely as possible. For stiff roller shutters, mount a deflection roller on the belt box. This helps to prevent unnecessary friction and wear to the belt.

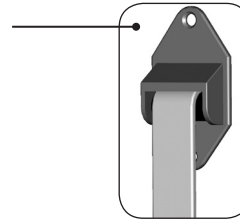
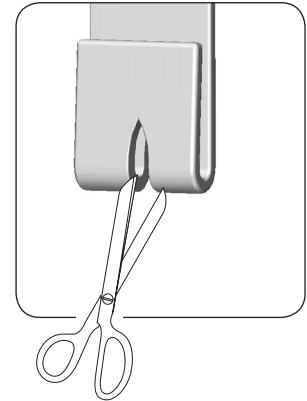
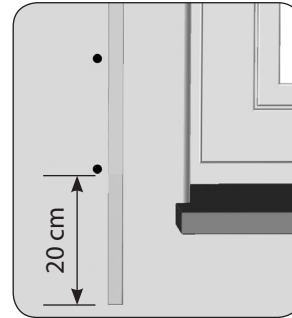

Accessories, see page 57.

### Note for mounting on window frames, etc.



### Weak window frames may break.

- ◆ When mounting on window frames, please check their structure and load capacity. Especially when mounting onto designs made of synthetic materials, the fastening screws must be screwed tight and must not loosen during operation.
- ◆ If required, ask your window manufacturer before fastening the belt winder onto a window frame made of synthetic materials.

1. Use the provided mounting holes.

Two mounting holes are required to fasten the belt winder. Generally, it is possible to use the existing mounting holes of the old belt winder to screw the wall brackets in place.

2. Draw on the new mounting holes.

Hold the wall bracket onto the desired installation position and draw on both mounting holes if new mounting holes need to be drilled.

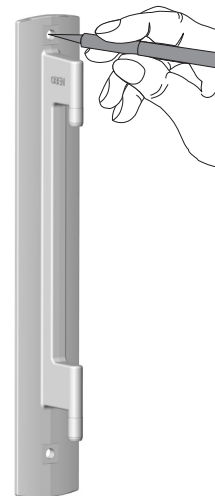

3. Drill mounting holes (only required for wall mounting).  
Drill the mounting holes with a 6 mm masonry drilling machine and place the provided wall plugs into the drilled holes.





The letterings "TOP" and "OBEN" on the wall bracket indicates the correct mounting position.

4. Screw on the wall bracket with the screws provided and ensure that the right side is facing upwards (TOP/OBEN).



Use the correct type of screw depending on the mounting surface, see the 'included in delivery' section on page 7.

- ◆ Wall mounting = 4 x 40 mm
- ◆ Mounting onto window frame = 4.2 x 19 mm

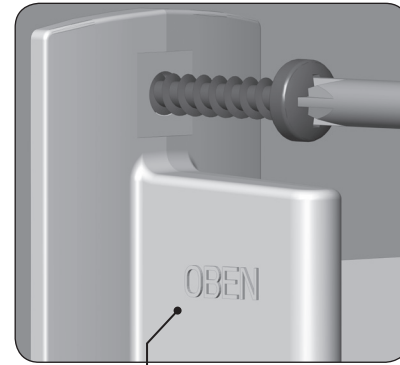
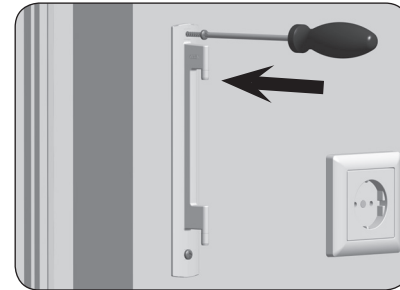

Indication of the correct mounting position on the wall bracket.

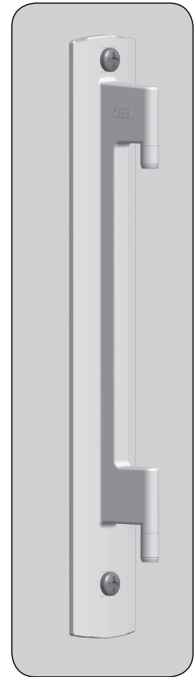

Correct mounting of the wall bracket.



## 11. Drawing in and fastening the belt

4. Next, draw-in the belt into the superrollo GW240/GW245 from the top.  
Feed the belt into the device, as shown in the image, and slide it over the Fastening hook from below.
5. Re-insert the mains plug into the socket.
6.  Press the up button until the belt has fully wound once around the reel.
7. Pull the belt tight when winding, so that the deflection roller turns at the same time.
8. Remove the mains plug again from the socket.
9. Finally, place the provided reel compartment cover onto the reel compartment.

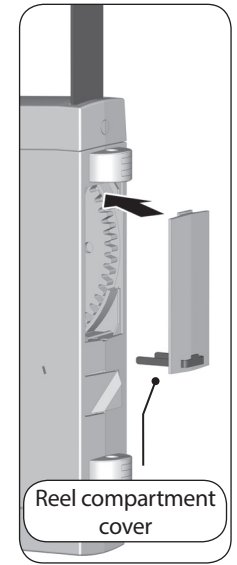
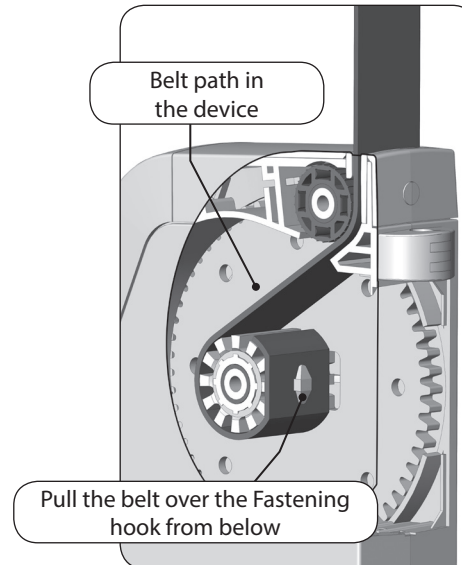
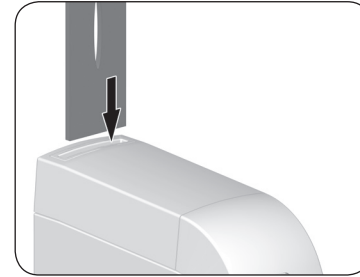

1. Slide the superollo GW240 / GW245 onto the wall bracket from below until it engages.  
Otherwise, the superollo GW240 / GW245 may fall off again.

**⚠ WARNING!**

**A damaged connecting cable may cause a short circuit.**

Ensure that the connecting cable is not pinched or damaged during the mounting process.

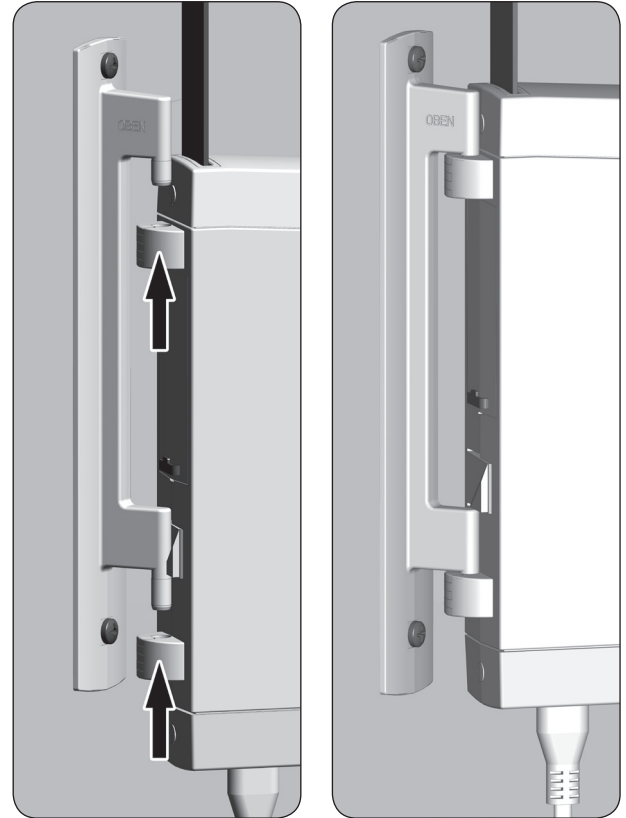

2. Mount the light sensor (not included, see page 57, Accessories).
  - ◆ Insert the light sensor plug into the designated connection socket on the bottom of the superrollo GW240 / GW245.
  - ◆ Subsequently secure the light sensor to the window pane using the suction cup.



The position of the light sensor on the window pane determines the point at which the roller shutters will close to in the event of sunlight.

3. Re-insert the mains plug into the 230 V / 50 Hz socket.



Leave the bottom cover plate of the setting buttons open until all settings have been carried out.

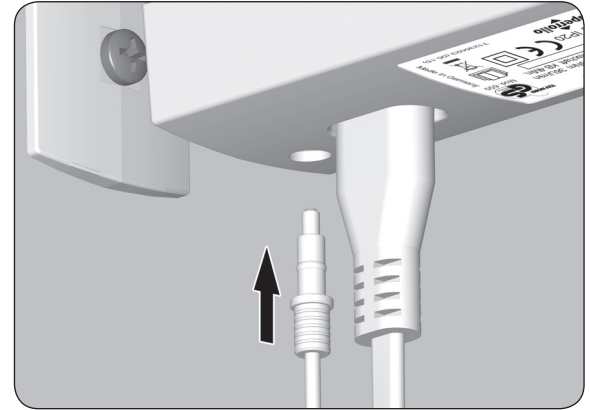

## i 13. Introduction to opening and setting the functions

EN

1. **M** Open the main menu.



Pressing the menu button in the standard display causes the main menu to open.

2. **+** / **-** Select the desired menu.



The selected menu is indicated by a flashing icon.

3. **OK** Open the menu by pressing the OK button, see example.



OFF flashes.

4. **+** / **-** Select the desired setting (e.g. On).



5. **OK** By confirming the setting you will return to the main menu.



6. **M** Back to the normal display



Briefly pressing the menu button causes the display to go back one menu step.

## **i** 14. Initial commissioning with the help of the installation wizard

The wizard automatically guides you through the configuration process for initial commissioning or after a software reset (see page 47).

With the help of the installation wizard you will be guided through the first basic settings.



Following power failure, the installation wizard will be started with the resetting of the date and time.

### **Restart the installation wizard**

As long as the installation wizard is still running, it can be restarted by pressing the menu button.

### **Readiness for operation**

The superrollo GW240 / GW245 is ready for use as soon as the installation wizard has finished.

In the main menu you can change your settings at any time, or add additional settings.

### **Additional information about configuring the end points**

The end points must be configured for the roller shutters to stop at the desired upper and lower positions.

It is imperative that both end points are configured, otherwise malfunctions may occur.



If the superrollo GW240 / GW245 is operated without an end point setting, the drive will continue to run as long as one of the two control buttons is actuated.

The automatic functions remain blocked until the end point setting is configured.

## i 14. Initial commissioning with the help of the installation wizard

1. The installation wizard appears as soon as the plug is plugged into the socket.



All icons and digits in the display will flash.

2. **OK** Activate the time setting function.



3. **+** / **-** Set the current time (hours:minutes) and confirm each entry.

**OK**



**OK**



4. **+** / **-** Set the current date (day.month) and confirm each entry.

**OK**



**OK**



5. **+** / **-** Set the current year and confirm the entry.

**OK**



6. Next, the upper end point must be set, see the next page.







## i 14. Initial commissioning with the help of the installation wizard

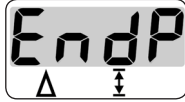

6. Set the upper end point.



- 6.1  Press and hold the Up button.  
*The roller shutter travels up.*

- 6.2 Tighten the belt slightly, until it is tensioned by the weight of the roller shutters.

- 6.3  Release the Up button, as soon as the roller shutter reaches the desired position for the upper end point.  
*The roller shutter stops.*

- 6.4  /  If necessary, the upper end point can be corrected once more.

- 6.5  Save the upper end point.

### ATTENTION!

**Setting the wrong upper end point may lead to overload or damage the superrollo GW240 / GW245 or the drive.**

- ◆ Do not set the upper end point right up to the limit stop.
- ◆ Release the Up button promptly and never allow it to extend beyond the respective end point.

7. Next the lower end point must be set, see the next page.

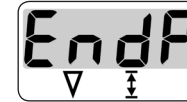



Please ensure that the belt is not excessively slack when reaching the lower end point.

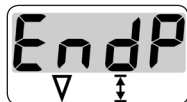

## i 14. Initial commissioning with the help of the installation wizard

7. Set the lower end point.



- 7.1  Press and hold the Down button.  
*The roller shutter travels down.*

- 7.2  Release the Down button, as soon as the roller shutter reaches the desired position for the lower end point.  
*The roller shutter stops.*

- 7.3  /  If necessary, the lower end point can be corrected once more.

- 7.4  Save the lower end point.



After a period of time it may be necessary to reconfigure the end points as the belt may elongate during the process of operation, see page 45.

8. The standard display is shown as soon as the final setting is confirmed.







*The superrollo GW240/GW245 is now ready for operation.*



## 15. Manual operation

Manual operation is possible in any of the modes and has priority over the programmed automatic functions.

-  Open the roller shutters.  
By briefly pressing the button, the roller shutters will move to the upper end point.
-  or  Stop the shutters in the interim.
-  Close the roller shutters.  
By briefly pressing the button, the roller shutters will move to the lower end point.

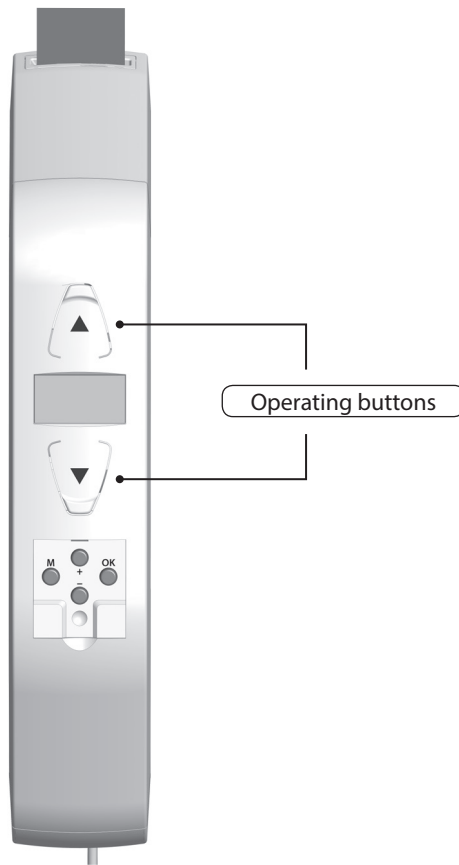

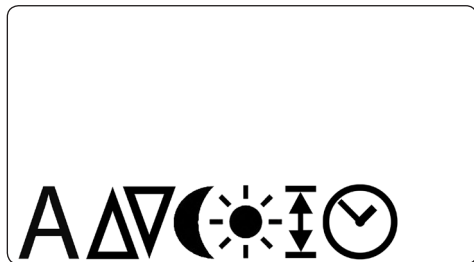

In the main menu, you can call up and set all of the functions for the superrollo GW240/GW245.



Manual operation is not possible from the main menu.

- ◆ No automatic switching commands will be executed during the configuration process.
- ◆ If nothing is entered within 60 seconds, the display changes back to the standard display.

#### Functions in the main menu

Pos.	Symbol	Description
1)	A	Automatic operation
2)		Switching times (opening / closing time)
3)		Automatic dusk function (with light sensor)
4)		Automatic solar function (with light sensor)
5)		End point setting
6)		Time and date

**Automatic mode [On]**

- ◆ All previously entered automatic mode functions are active.
- ◆ Manual operation is also possible in automatic mode.

**Automatic mode [OFF]**

- ◆ All previously entered automatic mode functions are deactivated.
- ◆ All automatic icons are switched off in the standard display.

1. **M** Open the main menu.

2. **+** / **-** Select automatic mode and open the menu.

**OK**



3. **+** / **-** Select the desired functions and confirm the entry.

**OK**



**On** = Automatic mode on

**OFF** = Automatic mode off

4. The main menu appears again once this is confirmed with the **OK** button.





## 16.2 Setting the switching times (opening and closing times)

EN

You can configure four different opening and closing times for the superrollo GW240 / GW245 in order to open or close your roller shutters at your preferred times.

### You can set the following switching times:

#### From Monday to Friday:

1 x opening time [ $\Delta$ ] + 1 x closing time [ $\nabla$ ]

#### For Saturday and Sunday:

1 x opening time [ $\Delta$ ] + 1 x closing time [ $\nabla$ ]



The different switching times automatically appear one after the other.

- ◆ By setting the switching times, the automatic mode is automatically switched on.

### Deactivating the switching times [ OFF ]

Each switching time can be deactivated individually.

When setting the hours between 23:00 and 0:00, the value OFF appears in the display.

#### Example:



OFF = Switching time off

1. **M** Open the main menu.
2. **+** / **-** Select the switching times and open the menu.

**OK**





## 16.2 Setting the switching times (opening and closing times)

### 3. Set the opening time [ $\Delta$ ] for Monday to Friday:

3.1  $\boxed{+}$  /  $\boxed{-}$  Set the desired opening time (hours:minutes) and confirm each entry.



### 4. Set the closing time [ $\nabla$ ] for Monday to Friday:

4.1  $\boxed{+}$  /  $\boxed{-}$  Set the desired closing time (hours:minutes) and confirm each entry.



### 5. Set the opening [ $\Delta$ ] and closing time [ $\nabla$ ] for Saturday and Sunday:

5.1  $\boxed{+}$  /  $\boxed{-}$  Select the desired switching times as shown in points 3.1 and 4.1.



6. After the last setting, the main menu appears once again.





## 16.3 Setting the automatic dusk function

The automatic dusk function causes the roller shutters to close to the lower end point automatically.

### Automatic dusk function with connected light sensor

At twilight, the roller shutters will lower to the lower end point after approx. 10 seconds. The roller shutters will open again once the configured opening time is reached or in the event of a manual Up command.

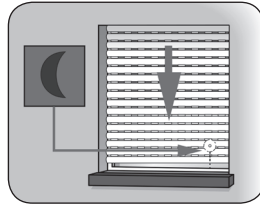

The required twilight limit is configurable.



The automatic dusk function is only executed once per day.

- ◆ By setting the automatic dusk function, the automatic mode is automatically switched on.
- ◆ Mounting the light sensor see page 42, Automatic solar function.

1. **M** Open the main menu.

2. **+** / **-** Select the automatic dusk function and open the menu.

**OK**



3. **+** / **-** Switch the automatic dusk function on and confirm the entry.

**OK**



**On** = Automatic dusk function on



**OFF** = Automatic dusk function off





## 16.3 Setting the automatic dusk function

### 4. Setting the twilight limit:

4.1  /  Set the desired limit.

**ACTUAL value**

Currently measured brightness (e.g. 10).  
"- -" = too bright



**SET value**

Configurable set limit

**01** = very dark, approx. 2 Lux

**15** = less dark, approx. 50 Lux

*If the set limit value is not met due to the onset of twilight, the roller shutters will close.*

4.2  Return to main menu.





## 16.4 Setting the automatic solar function

The automatic solar function enables brightness-dependent control of the roller shutters in combination with the light sensor. To do this, the light sensor is secured to the window pane with a suction cup and then plugged into the superrollo GW240/GW245.

### Automatic solar function

Automatic moving up and down of the roller shutter once a set limit is exceeded. The roller shutter end position can be freely selected by changing the light sensor position.



Please note the state of the sun icon on the standard display.

- ◆ During the activated automatic solar function, the corresponding icon flashes in the standard display as soon as sunlight is detected.
- ◆ By setting the automatic solar function, the automatic mode is automatically switched on.



**Example installation**

**The automatic solar function will be terminated and must be reactivated if required after the following events:**

- ◆ After manual actuation.
- ◆ After execution of an automatic function.
- ◆ After the upper end point is reached.



## 16.4 Setting the automatic solar function

### Automatic lowering

If the sensor detects uninterrupted sunlight for 10 minutes, the shutter will descend until its shadow covers the light sensor.

### Automatic clearing

After approx. 20 minutes, the roller shutter is automatically raised a small amount to uncover the sensor. If the sun continues to shine, then the roller shutter remains in this position. If the brightness decreases below the set limit, it returns to the upper end point.



The above-mentioned delay times can be exceeded in the event of changing weather conditions.

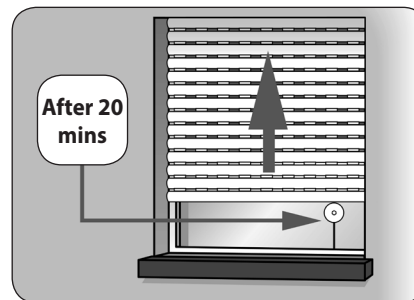
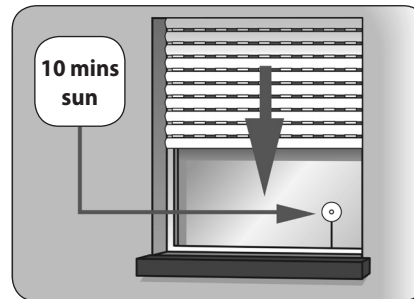



## 16.4 Setting the automatic solar function

1. **M** Open the main menu.

2. **+** / **-** Select the automatic solar function and open the menu.

**OK**



3. **+** / **-** Switch the automatic solar function on and confirm the entry.

**OK**



**On** = Automatic solar function on

**OFF** = Automatic solar function off

4. **Setting the solar limit value:**

4.1 **+** / **-** Set the desired limit.

### ACTUAL value

Currently measured brightness (e.g. 37).

"-." = too dark



### SET value

Configurable set limit

**31** = minimal sun, approx. 2000 Lux



**45** = bright sunlight, approx. 20000 Lux

4.2 **OK** Return to main menu.





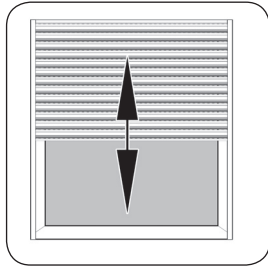

## 16.5 Setting the end points

1.  or  First move the roller shutters to the centre position.



2.  Open the main menu.

3.  /  Select the end point and open the menu.





### Setting order

Set the upper end point, see page 33.

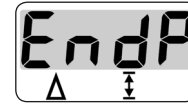

Set the lower end point, see page 34.

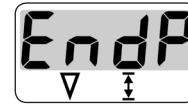



## 16.6 Set time and date

1. **M** Open the main menu.
2. **+** / **-** Select the time and date and open the menu.

**OK**



### Setting order

Set the time (hours:minutes),  
see page 32.



Set the date (day. month),  
see page 32.



Set the year,  
see page 32.



If necessary, you can erase all of your settings and return the superrollo GW240/GW245 system to its original factory settings.

1. Remove the cover plate from the setting buttons.

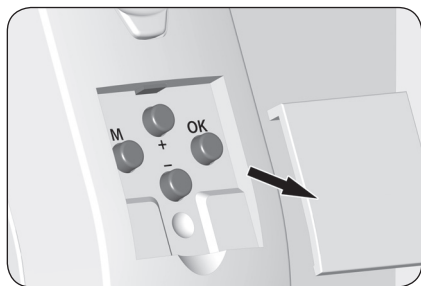

2. **M** + **OK** + **+** + **-**

Simultaneously press and hold the four buttons for 4 seconds.

3. This displays the software version for the superrollo GW240/GW245.



Example

4. After four seconds all icons on the display will light up.



5. Release the buttons and all of the settings will be deleted; the installation wizard will appear automatically.





6. Carry out the initial settings in the installation wizard, see page 31.



## 18. Removing the superrollo GW240 / GW245 (e.g. in the event of a move)

EN

1. Remove the cover plate from the setting buttons.
2. **M** + **OK** + **+** + **-**  
Erase all settings. Simultaneously press and hold the buttons for 4 seconds.
3.  Fully close the roller shutters.
4.  Continue to press and hold the down button.
5. In doing so, pull out the belt as far as possible from the top of the superrollo GW240 / GW245.
6.  Remove the mains plug from the socket and the small appliances plug from the superrollo GW240 / GW245.
7. Press the assembly locking device on the back part and remove the superrollo GW240 / GW245 from the wall bracket by pulling it downwards.

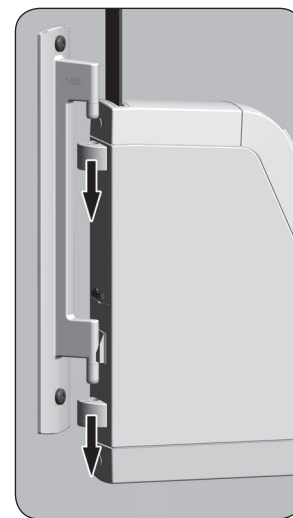
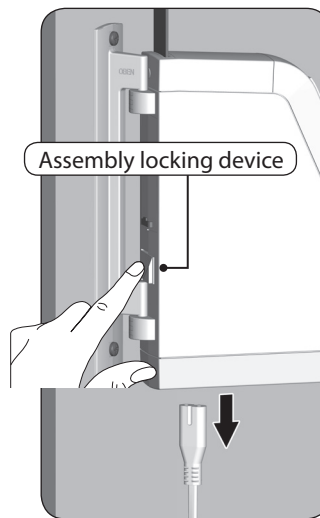
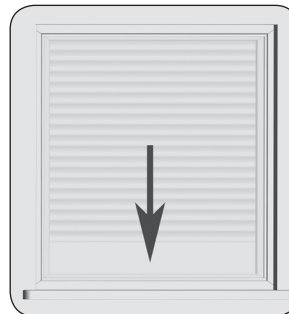



8. Remove the reel compartment cover and check the position of the fastening hook.
9. If necessary, move the fastening hook into an easily accessible position.
- 9.1 For this, plug the mains cable into the superrollo GW240 / GW245 and into the socket.

**⚠ CAUTION!**

**There is a risk of injury from the reel.**

- ◆ Never reach into the reel compartment when the motor is running.
- ◆ Always remove the mains plug before touching the reel compartment.

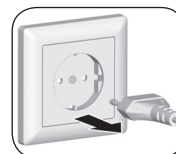
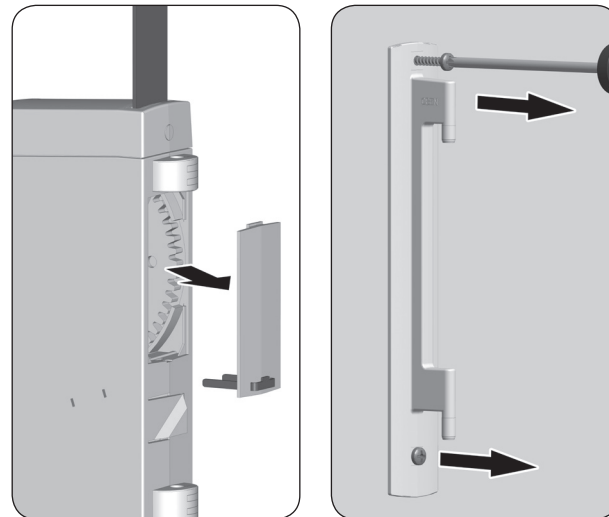

10. Finally, remove the mains plug again from the socket.
11. Release the belt from the fastening hook and pull it out completely from the top of the superrollo GW240 / GW245.
12. Finally, unscrew the wall bracket.

## i 19. Removing the belt in the event of unit failure

EN

In the event that the superrollo GW240/GW245 unit fails and the motor no longer runs, you can use the disengaging bracket provided in order to fully remove the belt from the belt winder unit, without the need for cutting it.

### **WARNING!**

**There is a risk of injury as the roller shutters may slam shut or fall in an uncontrolled manner.**

- ◆ Secure the roller shutters from falling, for example, by laying something underneath it.
- ◆ Hold on to the belt tightly to stop the roller shutters from slamming shut or falling in an uncontrolled manner.
- ◆ Get a second person to help you unlatch the unit.

1.



Remove the mains plug from the socket.

2.

Turn the superrollo GW240/GW245 completely to the side.

3.

Release the drive with the help of the supplied disengaging bracket. A small amount of resistance must be overcome when pressing.

4. Maintain pressure on the disengaging bracket and pull the belt out of the superrollo GW240/GW245 as far as possible.

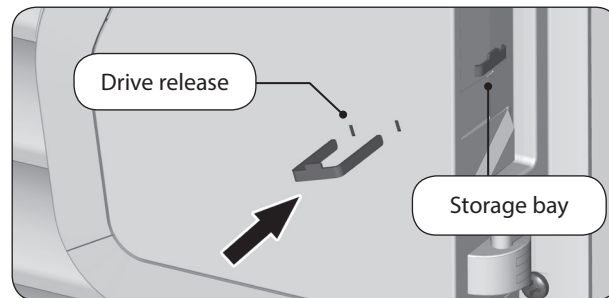

5. Remove the reel compartment cover. Release the belt from the fastening hook and fully pull it out of the superrollo GW240/GW245.
6. Press the assembly locking device on the back part and remove the superrollo GW240/GW245 from the wall bracket by pulling it downwards.
7. Place the disengaging bracket back into the storage compartment.

Fault	Possible cause / solution
... the superrollo GW240 / GW245 indicates no functions?	Check the power supply incl. connecting cable and plug.
... the superrollo GW240 / GW245 fails to react at the configured switching time?	a) There may have been a power failure, see page 14. Reset the time and date with the help of the installation wizard, see page 32.
	b) The automatic mode may have been deactivated. Switch the automatic mode on, see page 37.
... the roller shutters no longer stop at the configured end points?	The end points may be displaced due to elongation of the belt. Re-adjust the end points, see page 45.
... the roller shutters stop as soon as the operating button is released?	During initial installation or after a reset, there will be no end points set. In this case, you will need to reset the end points with the help of the installation wizard, see page 31.
... the superrollo GW240 / GW245 rotates in the wrong direction?	Possibly the belt is wrapped around the reel incorrectly, see page 27.
... the roller shutters stop suddenly during upward travel?	a) The drive may be jammed, for example, due to the roller shutters freezing up or other obstacles.
	b) The roller shutters may not be running sufficiently smoothly. Check the roller shutters and roller shutter guides.
	d) The roller shutters may be too heavy. The maximum tractive force of the belt winder has been exceeded, see page 54.

Fault	Possible cause / solution
... the roller shutters stop during downward travel?	<p>a) The roller shutters may have hit an obstacle. Move the roller shutters back up and remove the obstacle.</p> <p>b) Slats have shifted out of alignment. If possible, move the roller shutters back up and realign the slats.</p> <p>c) The roller shutters scrape against the window frame or inside the roller shutter box due to the lack of a pinch roller or insulation material may have come free and is jamming the roller shutters. Open the roller shutter box and rectify the fault. Lubricate any stiff areas with gliding wax.</p> <p>d) The roller shutters are too light. Increase the weight of the roller shutters by, for example, adding a piece of flat steel to the bottom slat.</p>
... the temperature display appears and the superrollo GW240 / GW245 fails to operate in either direction?	<p>The maximum running time of the drive has been exceeded, see page 15/18. The motor is too hot. The belt winder will be fully operational again in approx. 1 hour.</p>
... the superrollo GW240 / GW245 fails to react properly either manually or automatically?	<p>The superrollo GW240 / GW245 is no longer ready for operation. Carry out a software reset in accordance with the instructions on page 47 and test the superrollo GW240 / GW245 using the default factory settings.</p>

### Maintenance

---



**A lack of maintenance can lead to personal injury through damage to your superrollo GW240 / GW245 and the roller shutter system.**

---

- ◆ Please check the superrollo GW240 / GW245 and all of your roller shutter components regularly for damage.
  - Regularly check the superrollo GW240 / GW245 for correct functioning.
  - The blinds must not be damaged.
  - The belt may not be frayed.
  - The deflection roller on the roller shutter box must move freely.
  - The reel plate in the roller shutter box must be fastened and stable. It may become less stable when used over a longer period of time.
- ◆ Damaged components should be exchanged by a specialist roller shutter firm.

### Maintenance

---

You can clean the superrollo GW240 / GW245 using a damp cloth. Please do not use aggressive or abrasive cleaning agents.

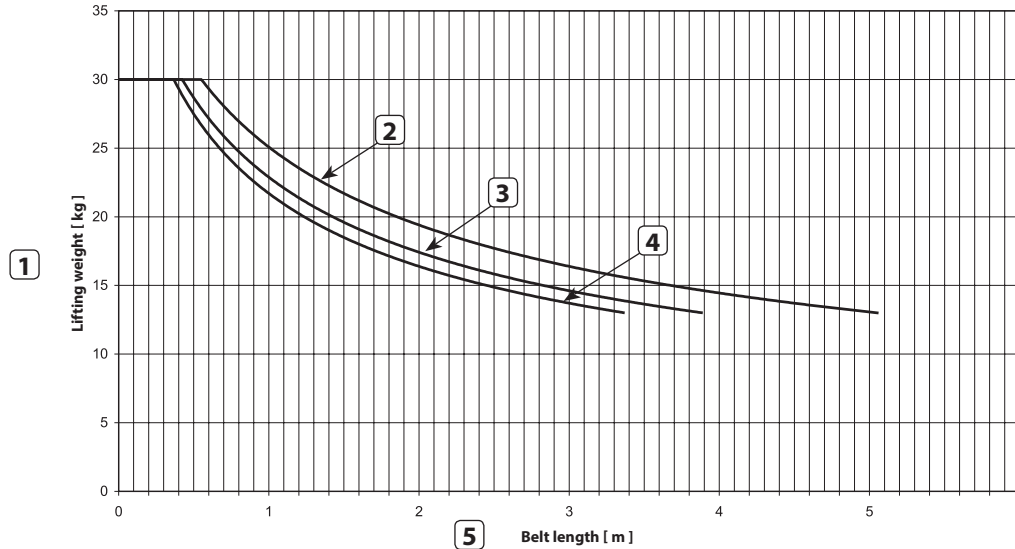

① Lifting weight [Kg]

② Belt thickness 1.0 mm

③ Belt thickness 1.3 mm

④ Belt thickness 1.5 mm

⑤ Belt length [m]

Pos.	Description	Status / settings
1)	Automatic operation	On
2)	Switching times (opening / closing time)	On
3)	Opening times (Monday to Friday)	7 am
4)	Closing times (Monday to Friday)	8 pm
5)	Opening times (Saturday and Sunday)	8 am
6)	Closing times (Saturday and Sunday)	10 pm
7)	Automatic dusk function	OFF
8)	Twilight limit value	07
9)	Automatic solar function	OFF
10)	Solar limit value	43
11)	Time / date	12:00 hours / 15.08.2015

The electronic roller shutter belt winder **superrollo GW240 / GW245** (item No.: SR10240 / SR10245) complies with the requirements of the current European and national directives:



**2006/42/EC**  
**Machinery Directive**  
**2014/30/EU**  
**EMC Directive**

The conformity has been verified and the corresponding declarations and documentation are available on file at the manufacturer's premises.

**superrollo Hausautomatisierung GmbH**  
Gewerbepark 1  
01156 Dresden (Germany)



### Sunlight / darkness sensor ZB30

In addition, you can equip the superollo GW240 / GW245 with a sunlight / darkness sensor.

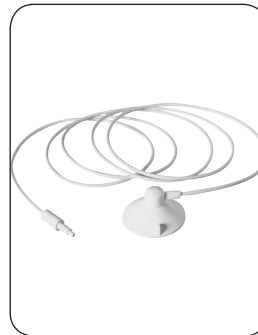

Item no. SR70030

superrollo Hausautomatisierung GmbH provides a 24-month warranty for new systems that have been installed in compliance with the installation instructions. All construction faults, material defects and manufacturing defects shall be covered by the warranty.

Your statutory warranty claims shall remain unaffected by this warranty.

**The following shall not be covered by the warranty:**

- ◆ Incorrect fitting or installation
- ◆ Non-observance of the installation and operating instructions
- ◆ Improper operation or wear and tear
- ◆ External influences, such as impacts, knocks or weathering
- ◆ Repairs and modifications by third parties, unauthorised persons
- ◆ Use of unsuitable accessories
- ◆ Damage caused by unacceptable excess voltages (e.g. lightning)
- ◆ Operational malfunctions caused by radio frequency overlapping and other such radio interference

A prerequisite for the warrant is that the new device must have been purchased from one of our approved specialist retailers. Proof of this must be provided by presenting a copy of the bill.

superrollo Hausautomatisierung GmbH will remedy any defects which occur within the warranty period free of charge either by repair or by replacement of the affected parts or by supply of a new replacement unit or one of the same value. There is no general extension of the original warranty period by delivery of a replacement or by repair as per the terms of the warranty.



**superrollo Hausautomatisierung GmbH**

Gewerbepark 1

01156 Dresden (Germany)

[www.superrollo-online.de](http://www.superrollo-online.de)

Service Hotline: 01807 001-655\*

\* 30 seconds free of charge, subsequently 14 cents / minute from German fixed line networks and max. 42 cents / minute from German mobile networks.