

## D-SERIES DRM DRMKITP 24VDC 4CO LD

**Weidmüller Interface GmbH & Co. KG**  
 Klingenbergstraße 16  
 D-32758 Detmold  
 Germany  
 Fon: +49 5231 14-0  
 Fax: +49 5231 14-292083  
 www.weidmueller.com

### Product image



Similar to illustration

Our relay kits are particularly convenient to use. The kits are delivered fully assembled and 100 % function-tested. This saves assembly time and reduces the number of parts required.

- Assembled kit consisting of relay, base and retaining clip, incl. label
- 100% function-tested
- 100% control of the dielectric strength input - output
- Optional: test button with coloured control voltage marking (AC coil: red / DC coil: blue) and mechanical switch position indicator
- Bright status LED (AC coil: red / DC coil: green)

### General ordering data

Type	DRMKITP 24VDC 4CO LD
Order No.	<a href="#">2576130000</a>
Version	D-SERIES DRM, Relays, No. of contacts: 4 CO contact AgNi 0,15 µm Au, Rated control voltage: 24 V DC, Continuous current: 5 A, PUSH IN with actuator
GTIN (EAN)	4050118585889
Qty.	10 pc(s).

**D-SERIES DRM  
DRMKITP 24VDC 4CO LD**

**Weidmüller Interface GmbH & Co. KG**  
 Klingenbergstraße 16  
 D-32758 Detmold  
 Germany  
 Fon: +49 5231 14-0  
 Fax: +49 5231 14-292083  
 www.weidmueller.com

**Technical data****Dimensions and weights**

Width	30.6 mm	Width (inches)	1.205 inch
Height	101.8 mm	Height (inches)	4.008 inch
Depth	42.7 mm	Depth (inches)	1.681 inch
Net weight	110.846 g		

**Temperatures**

Humidity	35...85 % rel. humidity, no condensation	Operating temperature, max.	55 °C
Operating temperature, min.	-40 °C	Storage temperature, max.	70 °C
Storage temperature, min.	-40 °C	Operating temperature	-40 °C...55 °C
Storage temperature	-40 °C...70 °C		

**Environmental Product Compliance**

REACH SVHC	Lead 7439-92-1
------------	----------------

**Input**

Rated control voltage	24 V AC	Rated current DC	36.9 mA
Power rating	0.9 W	Pull-in/drop-out voltage, typ.	18 V / 2.4 V DC
Coil resistance	630 Ω ± 10 %	Status indicator	Green LED
Protective circuit	Free-wheeling diode		

**Output**

Rated switching voltage	250 V AC	Max. switching voltage, AC	250 V
Continuous current	5 A	Inrush current	10 A / 50 ms
Switch-on delay	< 20 ms	Switch-off delay	< 20 ms
Min. switching power	10 mA @ 12 V, 100 mA @ 5 V	Max. switching frequency at rated load	0.1 Hz

**Contact data**

Contact type	4 CO contact (AgNi 0,15 µm Au)	Contact resistance	≤ 50 mΩ
Mechanical service life	20 x 10 <sup>6</sup> switching cycles		

**General data**

Rail	TS 35	Test button	No
Mechanical switch position indicator	Yes	Colour	black

**Insulation coordination**

Rated voltage	250 V	Surge voltage category	III
Pollution severity	2	Insulating material group	C
Protection degree	IP20	Dielectric strength, Input/Output	1.8 kV <sub>eff</sub> / 1 min.
Creepage and clearance distance input - output	≥ 3 mm	Dielectric strength of neighbouring contacts	1 kV <sub>eff</sub> / 1 min
Dielectric strength of open contact	1 kV <sub>eff</sub> / 1 min		

**Further details of approvals / standards**

Certificate no. (cURus) relay	E312083	Certificate no. (cURus) base	E355547
-------------------------------	---------	------------------------------	---------

Creation date May 27, 2019 6:32:21 PM CEST

**D-SERIES DRM**  
**DRMKITP 24VDC 4CO LD**

**Weidmüller Interface GmbH & Co. KG**  
 Klingenbergstraße 16  
 D-32758 Detmold  
 Germany  
 Fon: +49 5231 14-0  
 Fax: +49 5231 14-292083  
 www.weidmueller.com

**Technical data**
**Connection data**

Wire connection method	PUSH IN with actuator	Stripping length, rated connection	10 mm
Clamping range, rated connection	1.5 mm <sup>2</sup>	Clamping range, min.	0.14 mm <sup>2</sup>
Clamping range, max.	1.5 mm <sup>2</sup>	Wire connection cross section AWG, min.	AWG 26
Wire connection cross section AWG, max.	AWG 16	Wire cross-section, solid, min.	0.14 mm <sup>2</sup>
Wire cross-section, solid, max.	1.5 mm <sup>2</sup>	Wire connection cross-section, finely stranded, min.	0.14 mm <sup>2</sup>
Wire connection cross section, finely stranded, max.	1.5 mm <sup>2</sup>	Wire connection cross-section, finely stranded with wire-end ferrules DIN 46228/4, min.	0.14 mm <sup>2</sup>
Wire connection cross-section, finely stranded with wire-end ferrules DIN 46228/4, max.	1 mm <sup>2</sup>	Conductor cross-section, flexible, AEH (DIN 46228-1), min.	0.14 mm <sup>2</sup>
Conductor cross-section, flexible, AEH (DIN 46228-1), max.	1.5 mm <sup>2</sup>	Blade size	0.4 x 2.5 mm

**Classifications**

ETIM 6.0	EC001437	eClass 6.2	27-37-16-01
eClass 9.0	27-37-16-01	eClass 9.1	27-37-16-01

**Downloads**

Approval/Certificate/Document of Conformity	<a href="#">EU Konformitätserklärung / EU Declaration of Conformity</a>
Engineering Data	<a href="#">EPLAN</a>
Engineering Data	<a href="#">STEP</a>

**D-SERIES DRM  
DRMKITP 24VDC 4CO LD**

**Weidmüller Interface GmbH & Co. KG**  
 Klingenbergstraße 16  
 D-32758 Detmold  
 Germany  
 Fon: +49 5231 14-0  
 Fax: +49 5231 14-292083  
 www.weidmueller.com

**Drawings**

**Wiring diagram**

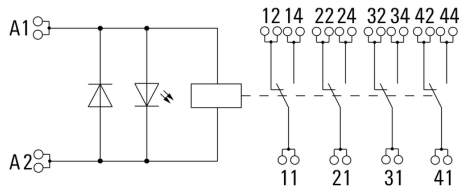

**Graph**

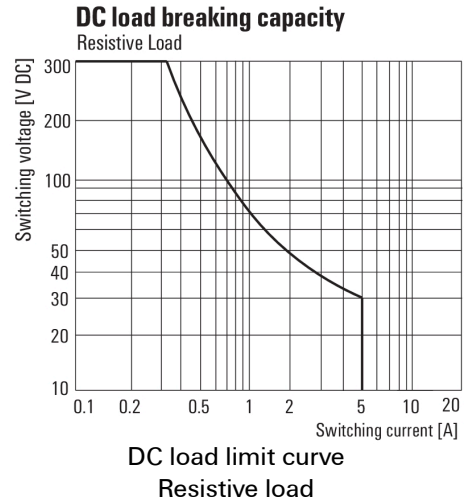

**Graph**

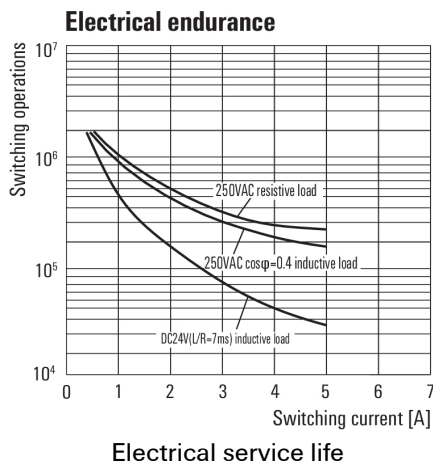

**Graph**

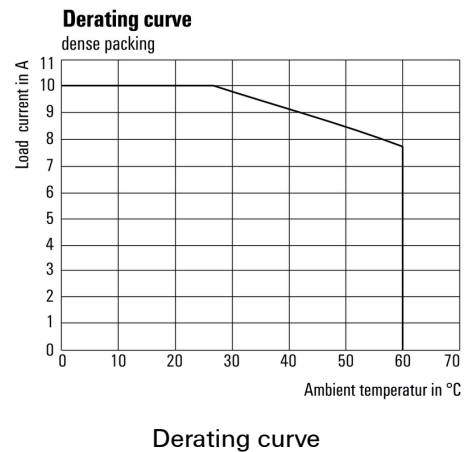

**Graph**

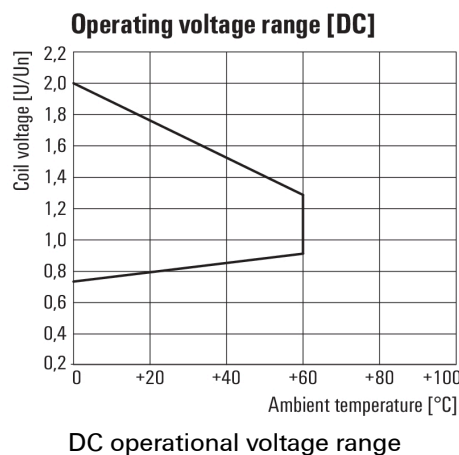

**Dimensional drawing**

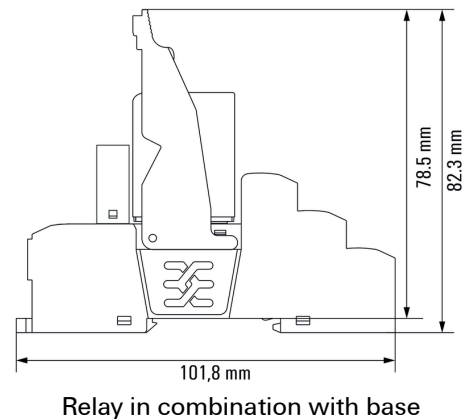

**Data sheet**

**D-SERIES DRM  
DRMKITP 24VDC 4CO LD**

**Weidmüller Interface GmbH & Co. KG**  
 Klingenbergstraße 16  
 D-32758 Detmold  
 Germany  
 Fon: +49 5231 14-0  
 Fax: +49 5231 14-292083  
 www.weidmueller.com

**Drawings**

**Miscellaneous**

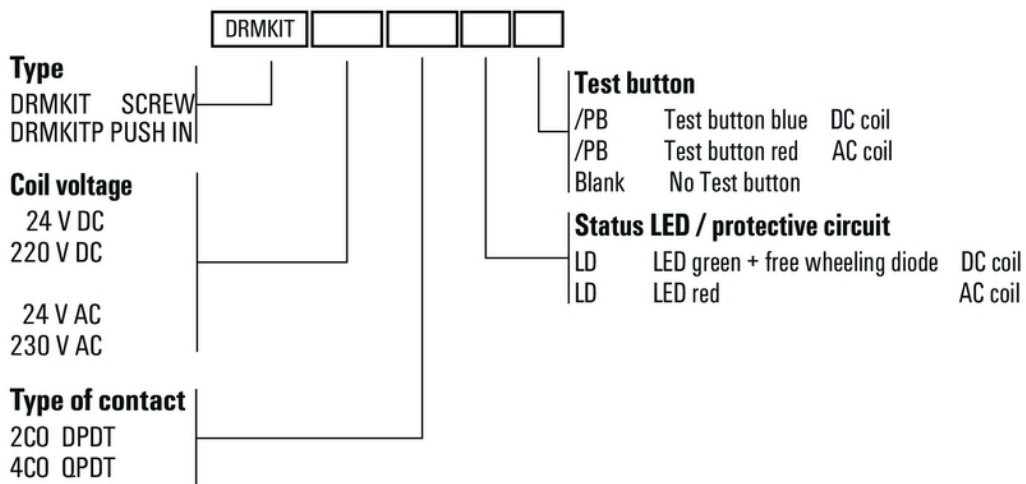

Type codes