

NS 7.10 FL30 MZ 4 AL (481 004)

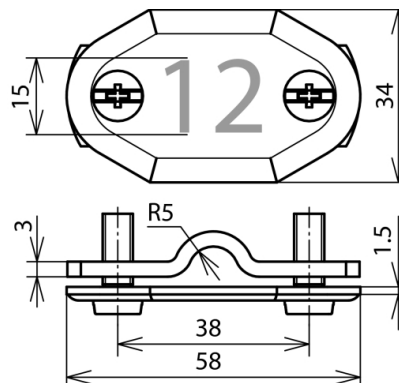

Figure without obligation

Type	NS 7.10 FL30 MZ 4 AL
Part No.	481 004
Material	Al
Number	4
Clamping range Rd / FI	7-10 / 30 mm
Screw	☒ M6 x 16 mm
Material of screw	StSt
Standard	DIN 48821
Weight	26 g
Customs tariff number (Comb. Nomenclature EU)	83100000
GTIN	4013364161054
PU	1 pc(s)

We reserve the right to introduce changes in performance, configuration and technology, dimensions, weights and materials in the course of technical progress. The figures are shown without obligation.

Any other numbering or labelling of the number plates available upon request!