

# Type 5TT / 5TTP

## Slow Blow Fuse Series

HF  5TT/5TTP Series, 5x20mm Glass/Ceramic Tube Slow Blow Fuse RoHS 2 Compliant

### Description

5x20mm Slow Blow, glass / ceramic tube body cartridge fuse designed, approved and complied with UL and CSA standard 248-14.



### Features

- Meet UL and CSA standard 248-14
- Wide operating temperature range
- Bulk and Tape & Reel packing available
- RoHS 2 compliant
- Halogen Free
- Leadfree

### Applications



Provide individual protection for components or internal circuits.

- Power supplies
- Battery charger
- Monitor
- Adapter

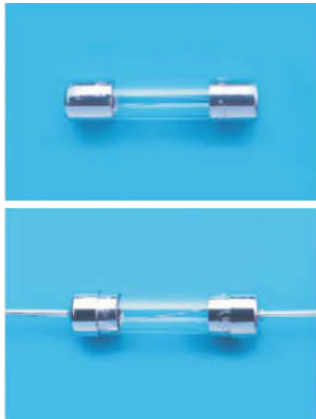
LEAD FREE =   
 HALOGEN FREE = 







### Physical Specifications

Materials	Body : Glass or Ceramic (see info below)
	Cap : Nickel Plated Brass Caps
	Leads : Matte Tin Plated Copper
Marking	On Fuse :
	"bel", "5TT", "Current Rating", "Voltage Rating", "Appropriate Safety Logos", "✓" ( RoHS 2 compliant)
	On Label :
	"bel", "5TT" or "5TTP", "Current Rating", "Voltage Rating", "Interrupting Rating", "Appropriate Safety Logos" and "  ", "  "(China RoHS compliant).

### Electrical Characteristics (UL/CSA STD,248-14)

Testing Current	Blow Time		Amp Range
	Minimum	Maximum	
100%	4 hrs.	N/A	80mA-10A
135%	N/A	1 Hr.	80mA-10A
200%	5 sec	30 sec	80mA-3A
	3 sec	30 sec	3.1A-10A

### Safety Agency Approvals





Safety Agency	Safety Agency Certificate	Voltage Rating (V)	Ampere Range / Volt @ I.R. ability*
	E20624	80mA-3A/250V AC	80mA-3A/250V AC@100A 80mA-8A/125V AC@10,000A
	LR39772		
	E20624	3.15A-10A/ 125V AC	10A/125V AC@1,000A
	LR39772		
	JET1037-31003-1010		1A-5A/125V AC@500A
	JET1037-31003-1011		
	JET1037-31003-1007		

\*I.R.= Interrupting Rating = Short Circuit Rating(Amps)

## Environmental Specifications

Shock Resistance	MIL-STD-202G, Method 213B, Test Condition 1 (100 G's peak for 6 milliseconds; Sawtooth waveform)
Vibration Resistance	MIL-STD-202G, Method 201A (10-55 Hz, 0.06 inch, total excursion).
Salt Spray Resistance	MIL-STD-202G, Method 101E, Test Condition B (48 hrs).
Insulation Resistance	MIL-STD-202G, Method 302, Test Condition A (After Opening) 10,000 ohms minimum.
Solderability	MIL-STD-202G, Method 208H
Resistance to solder Heat	MIL-STD-202G, Method 210F, Test Condition B (260+/-5°C, 10+/-1 sec)
Thermal Shock	MIL-STD-202G, Method 107G, Test Condition B (-65°C to +125°C).
Operating Temperature	-55°C to +125°C
Terminal Strength	IEC-68-2-21

## Electrical Specifications

Catalog Number	Ampere Rating	Typical Cold Resistance (ohms)	Volt-drop @100%In (Volt) max.	Voltage and Interrupting Ratings	Melting I <sup>2</sup> T <10 mSec (A <sup>2</sup> Sec)	Melting I <sup>2</sup> T @10 In (A <sup>2</sup> Sec)	Maximum Power Dissipation (W)	Agency Approvals				
												
5TT(P) 80-R	80mA	29	3.10	See Table of Safety Approvals on Page 1 for Voltage and associated Interrupting Ratings	0.091	0.096	0.42	Y			Y	
5TT(P) 100-R	100mA	18.8	2.52		0.137	0.146	0.45	Y			Y	
5TT(P) 125-R	125mA	12.6	2.22		0.208	0.221	0.48	Y			Y	
5TT(P) 160-R	160mA	7.6	1.88		0.314	0.337	0.51	Y			Y	
5TT(P) 200-R	200mA	4.98	1.45		0.476	0.512	0.55	Y			Y	
5TT(P) 250-R	250mA	3.39	1.25		0.719	0.778	0.58	Y			Y	
5TT(P) 300-R	300mA	2.13	0.97		0.885	0.959	0.60	Y			Y	
5TT(P) 400-R	400mA	1.33	0.83		1.65	1.80	0.66	Y			Y	
5TT(P) 500-R	500mA	0.865	0.67		2.5	2.7	0.70	Y			Y	
5TT(P) 600-R	600mA	0.679	0.64		3.8	4.2	0.75	Y			Y	
5TT(P) 700-R	700mA	0.465	0.49		4.6	5.1	0.78	Y			Y	
5TT(P) 750-R	750mA	0.438	0.48		5.3	5.8	0.79	Y			Y	
5TT(P) 1-R	1A	0.258	0.40		8.6	9.6	0.85	Y			Y	Y
5TT(P) 1.25-R	1.25A	0.179	0.34		13	15	0.91	Y			Y	Y
5TT(P) 1.5-R	1.5A	0.126	0.30		18	21	0.96	Y			Y	Y
5TT(P) 1.6-R	1.6A	0.116	0.30		20	22	0.97	Y			Y	Y
5TT(P) 2-R	2A	0.081	0.27		30	34	1.03	Y			Y	Y
5TT(P) 2.5-R	2.5A	0.056	0.23		45	51	1.10	Y			Y	Y
5TT(P) 3-R	3A	0.043	0.21		56	63	1.13	Y			Y	Y
5TT(P) 3.15-R	3.15A	0.040	0.21		68	78	1.17				Y	Y
5TT(P) 4-R	4A	0.029	0.19		103	119	1.25				Y	Y
5TT(P) 5-R	5A	0.020	0.17		157	180	1.33				Y	Y
5TT(P) 6-R	6A	0.015	0.15		218	317	1.23				Y	Y
5TT(P) 6.3-R	6.3A	0.014	0.12		230	345	1.25				Y	Y
5TT(P) 7-R	7A	0.012	0.13		295	459	1.37				Y	Y
5TT(P) 8-R	8A	0.011	0.13		319	472	1.31				Y	Y
5TT(P) 10-R	10A	0.008	0.13		467	703	1.40		Y	Y		Y

Consult manufacturer for other ratings



Specifications subject to change without notice

**Bel Fuse Inc.**  
206 Van Vorst Street  
Jersey City, NJ 07302 USA

+1 201.432.0463  
Bel.US.CS@belf.com  
[belfuse.com/circuit-protection](http://belfuse.com/circuit-protection)

## Temperature Derating Curve

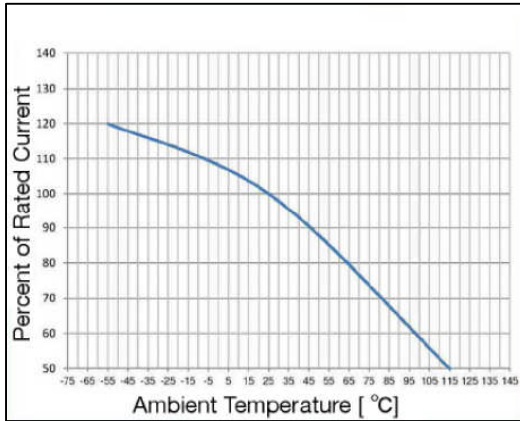

## Average Time Current Curve

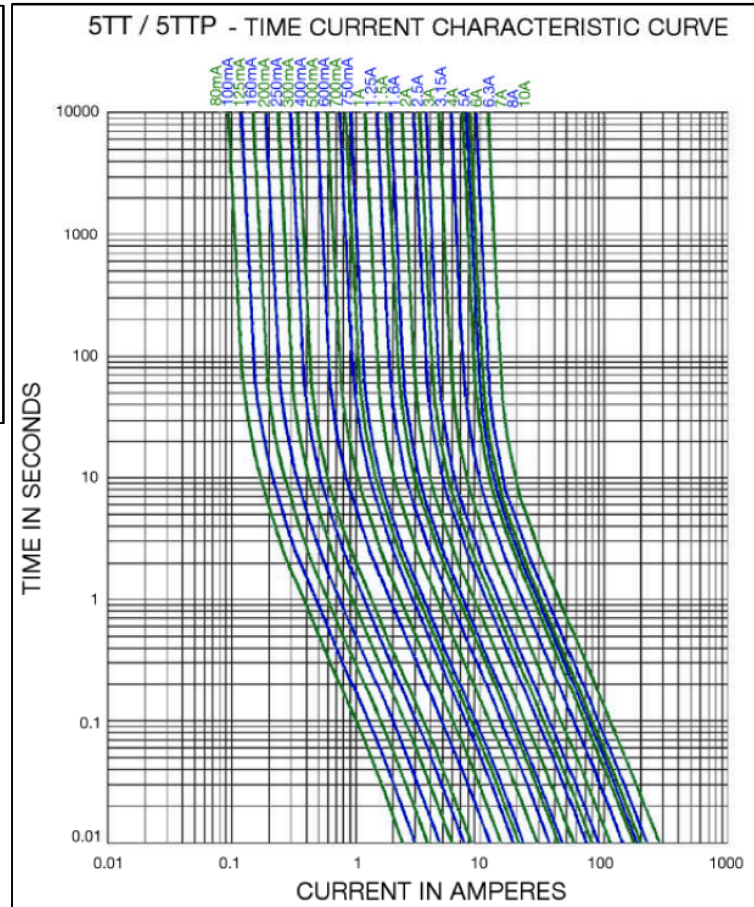

## Soldering Parameters

Lead-free Wave Soldering Profile	
Wave Soldering Parameter	
Average ramp-up rate	200°C / second
Heating rate during preheat	typical 1 - 2°C / second Max 4°C / second
Final preheat temperature	within 125°C of soldering temperature
Peak temperature T <sub>p</sub>	260°C
Time within +0°C / -5°C of actual peak temperature	10 seconds
Ramp-down rate	5°C / second max.

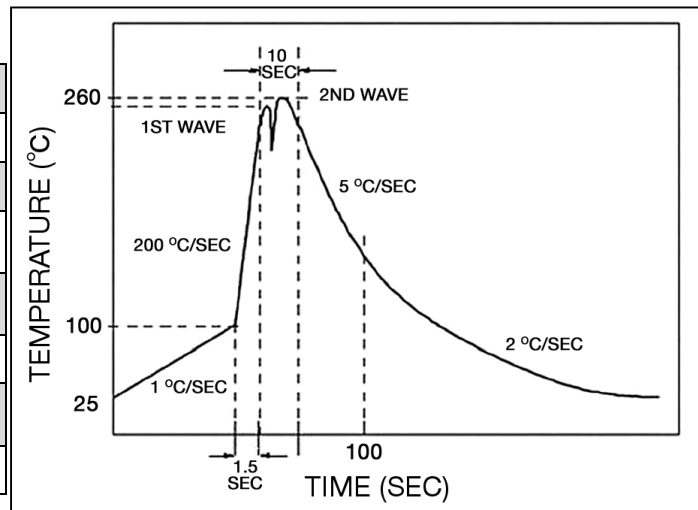

## Fuse FGNO Explanation

### 0654 R [XXXX] -XX

[XXXX]=Ampere Rating; XX=See Ordering Information as below

Fraction	Decimal	Milliamps	Bel FGNO[XXXX]
8/100	0.080	80	0080
1/10	.100	100	0100
1/8	.125	125	0125
	.160	160	0160
2/10	.200	200	0200
1/4	.250	250	0250
3/10	.300	300	0300
4/10	.400	400	0400
1/2	.500	500	0500
6/10	.600	600	0600
7/10	.700	700	0700
3/4	.750	750	0750

Fraction	Decimal	Amps	Bel FGNO[XXXX]
	1.0	1	1000
1-1/4	1.25	1.25	1250
1-1/2	1.50	1.5	1500
	1.60	1.6	1600
	2.0	2	2000
2-1/2	2.5	2.5	2500
	3.0	3	3000
	3.15	3.15	3150
	4.0	4	4000
	5.0	5	5000
	6.0	6	6000
	6.3	6.3	6300
	7.0	7	7000
	8.0	8	8000
		10	9100

## Mechanical Dimensions

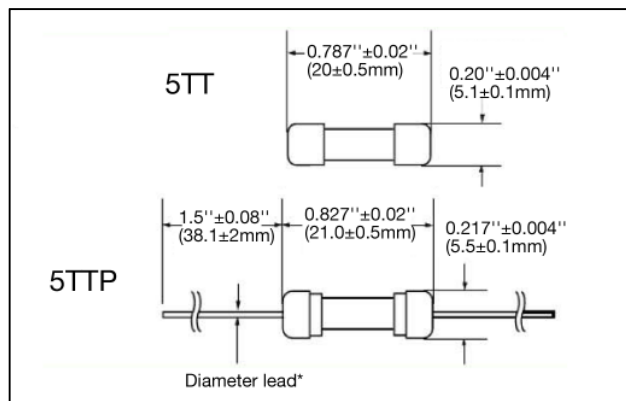

\*Ratings 5A and less have 0.032" diameter lead;  
 \*Ratings 6A and above have 0.040" diameter lead.

## Ordering Information

0654 R XXXX - X X

FUSE TYPE \_\_\_\_\_

0654RXXXX-XX = 5TT/5TTP Series [X>1]

R = RoHS Compliant \_\_\_\_\_

AMPERE RATING \_\_\_\_\_

Refer to fuse FGNO explanation table

VOLTAGE / MECHANICAL / SAFETY AGENCY \_\_\_\_\_

2 = 125V for > 3A - 10A  
 3 = 250V for 80mA - 3A  
 5 = Ceramic tube for 6A and above

PACKAGING CODE \_\_\_\_\_

1 = Cartridge version, 1K / box  
 3 = Pigtail version, 1K bulk pack  
 6 = Pigtail version, Tape and Reel, 1500 / reel

## Packaging

Packaging Option	Packaging Specification	Quantity	Packaging Code	Inside Tape Spacing
Bulk	N/A	1000	33 / 21 / 51	N/A
Bulk (Pigtail Type)	N/A	1000	33 / 23 / 53	N/A
Tape & Reel, 10mm Pitch	EIA-296-F	1500	36 / 26 / 56	63



Specifications subject to change without notice

Bel Fuse Inc.  
 206 Van Vorst Street  
 Jersey City, NJ 07302 USA

+1 201.432.0463  
 Bel.US.CS@belf.com  
[belfuse.com/circuit-protection](http://belfuse.com/circuit-protection)