

Type 5MT / 5MTP

Medium Blow Fuse Series

HF  5MT/5MTP Series, 5x20mm Glass Tube Medium Blow Fuse

RoHS 2 Compliant

Description

5x20mm Medium Blow, glass tube body cartridge fuse designed, approved and complied with UL and CSA standard 248-14.



Features

- Meet UL and CSA standard 248-14
- Wide operating temperature range
- Bulk and Tape & Reel packing available
- RoHS 2 compliant
- Halogen Free
- Leadfree

Applications



Provide individual protection for components or internal circuits.

- Power supplies
- Battery charger
- Monitor
- Adapter

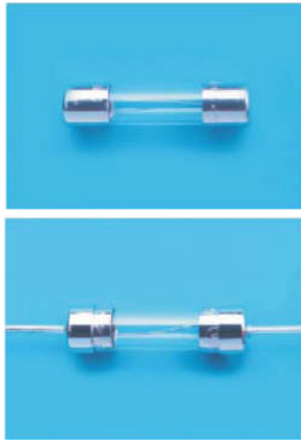
LEAD FREE = 
 HALOGEN FREE = 





Physical Specifications

Materials	Body : Glass
	Cap: Nickel Plated Brass Caps
	Leads: Matte Tin Plated Copper
Marking	On Fuse :
	"bel", "5MT", "Current Rating", "Voltage Rating", "Appropriate Safety Logos", "✓" (RoHS 2 compliant)
	On Label :
	"bel", "5MT" or "5MTP", "Current Rating", "Voltage Rating", "Interrupting Rating", "Appropriate Safety Logos" and "  ", "  "(China RoHS compliant).

Electrical Characteristics (UL/CSA STD,248-14) Safety Agency Approvals

Testing Current	Blow Time	
	Minimum	Maximum
100%	4 Hrs.	N/A
135%	N/A	1 Hr.
200%	N/A	15 sec
1000%	10 mSec	N/A



Safety Agency	Safety Agency Certificate	Voltage Rating (V)	Ampere Range / Volt @ I.R. ability*
	E20624	100mA-3A/250V AC	100mA-800mA/250V AC@35A
	LR39772		1A-3A/250V AC@100A
	JET1037-31003-1010	3.15A-7A/125V AC	100mA-5A/125V AC@10,000A
	JET1037-31003-1011		1A-5A/125V AC@500A
	JET1037-31003-1007		>5A-15A/125V AC@300A

*I.R.= Interrupting Rating = Short Circuit Rating(Amps)

Environmental Specifications

Shock Resistance	MIL-STD-202G, Method 213B, Test Condition 1 (100 G's peak for 6 milliseconds; Sawtooth waveform)
Vibration Resistance	MIL-STD-202G, Method 201A (10-55 Hz, 0.06 inch, total excursion).
Salt Spray Resistance	MIL-STD-202G, Method 101E, Test Condition B (48 hrs).
Insulation Resistance	MIL-STD-202G, Method 302, Test Condition A (After Opening) 10,000 ohms minimum.
Solderability	MIL-STD-202G, Method 208H
Resistance to solder Heat	MIL-STD-202G, Method 210F, Test Condition B. (260+/-5°C, 10+/-1 sec)
Thermal Shock	MIL-STD-202G, Method 107G, Test Condition B (-65°C to +125°C).
Operating Temperature	-55°C to +125°C
Terminal Strength	IEC-68-2-21

Electrical Specifications

Catalog Number	Ampere Rating	Typical Cold Resistance (ohms)	Volt-drop @100%In (Volt) max.	Voltage and Interrupting Ratings	Melting I ² T <10 mSec (A ² Sec)	Melting I ² T @10 In (A ² Sec)	Maximum Power Dissipation (W)	Agency Approvals		
										
5MT(P) 100-R	100mA	11.9	2.02	See Table of Safety Approvals on Page 1 for Voltage and associated Interrupting Ratings	0.02	0.04	0.30	Y	Y	
5MT(P) 125-R	125mA	7.92	1.77		0.04	0.07	0.32	Y	Y	
5MT(P) 160-R	160mA	4.82	1.33		0.06	0.11	0.34	Y	Y	
5MT(P) 200-R	200mA	3.11	1.13		0.11	0.18	0.36	Y	Y	
5MT(P) 250-R	250mA	2.12	0.94		0.18	0.30	0.38	Y	Y	
5MT(P) 300-R	300mA	1.51	0.80		0.31	0.50	0.37	Y	Y	
5MT(P) 375-R	375mA	1.07	0.73		0.47	0.75	0.40	Y	Y	
5MT(P) 500-R	500mA	0.61	0.57		0.88	1.40	0.43	Y	Y	
5MT(P) 600-R	600mA	0.430	0.44		1.5	2.3	0.45	Y	Y	
5MT(P) 700-R	700mA	0.340	0.42		2.2	2.5	0.48	Y	Y	
5MT(P) 750-R	750mA	0.290	0.39		2.3	3.5	0.49	Y	Y	
5MT(P) 800-R	800mA	0.261	0.36		3.8	4.2	0.49	Y	Y	
5MT(P) 1-R	1A	0.183	0.33		4.2	6.4	0.49	Y	Y	Y
5MT(P) 1.25-R	1.25A	0.124	0.28		7.2	11	0.52	Y	Y	Y
5MT(P) 1.6-R	1.6A	0.081	0.23		12	18	0.55	Y	Y	Y
5MT(P) 2-R	2A	0.061	0.22		20	29	0.59	Y	Y	Y
5MT(P) 2.5-R	2.5A	0.043	0.19		35	49	0.65	Y	Y	Y
5MT(P) 3-R	3A	0.036	0.19		58	82	0.74	Y	Y	Y
5MT(P) 3.5-R	3.5A	0.029	0.18		76	105	0.84	Y	Y	Y
5MT(P) 4-R	4A	0.025	0.18		99	136	0.91	Y	Y	Y
5MT(P) 5-R	5A	0.019	0.17	167	226	1.10	Y	Y	Y	
5MT(P) 6-R	6A	0.014	0.16	315	428	1.30			Y	
5MT(P) 7-R	7A	0.012	0.15	750	1059	2.10			Y	

Consult manufacturer for other ratings



Specifications subject to change without notice

Bel Fuse Inc.
206 Van Vorst Street
Jersey City, NJ 07302 USA

+1 201.432.0463
Bel.US.CS@belf.com
belfuse.com/circuit-protection

Temperature Derating Curve

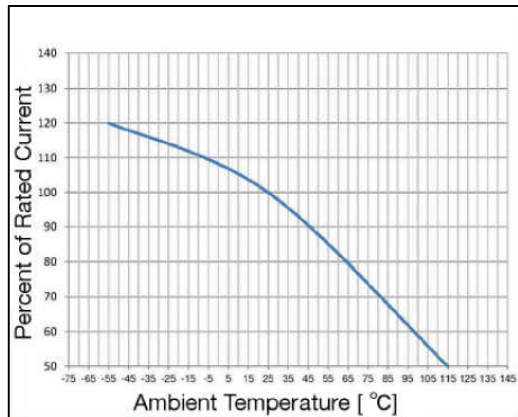

Average Time Current Curve

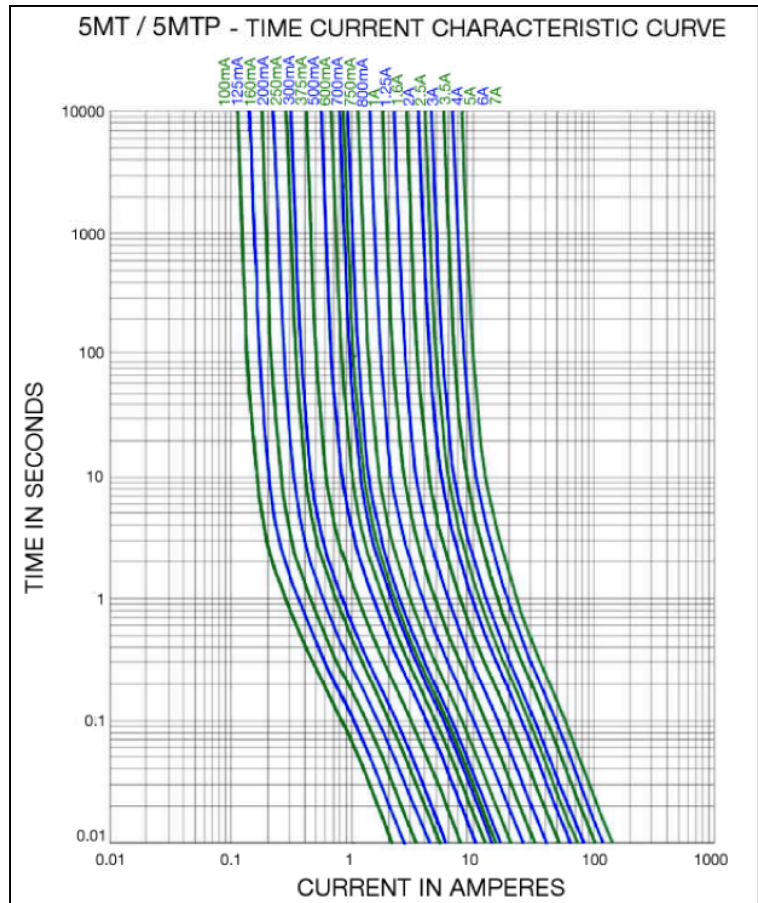

Soldering Parameters

Lead-free Wave Soldering Profile	
Wave Soldering Parameter	
Average ramp-up rate	200°C / second
Heating rate during preheat	typical 1 - 2°C / second Max 4°C / second
Final preheat temperature	within 125°C of soldering temperature
Peak temperature T _p	260°C
Time within +0°C / -5°C of actual peak temperature	10 seconds
Ramp-down rate	5°C / second max.

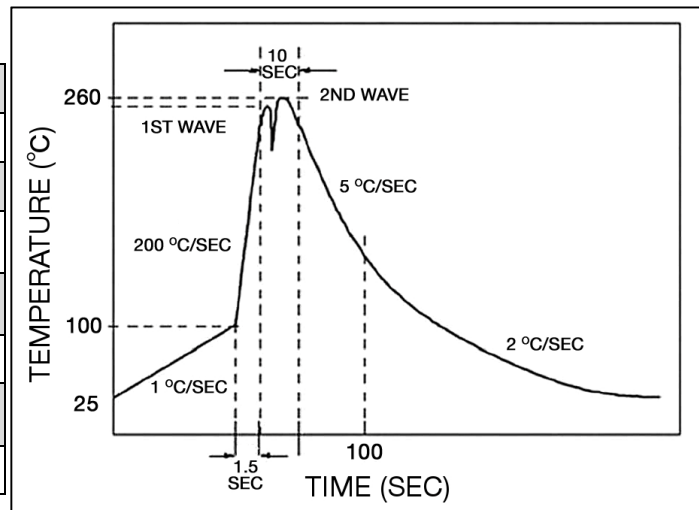

Fuse FGNO Explanation

0652 R [XXXX] -XX

[XXXX]=Ampere Rating; XX=See Ordering Information as below

Fraction	Decimal	Milliamps	Bel FGNO[XXXX]
1/10	0.100	100	0100
1/8	.125	125	0125
	.160	160	0160
2/10	.200	200	0200
1/4	.250	250	0250
3/10	.300	300	0300
3/8	.375	375	0375
1/2	.500	500	0500
6/10	.600	600	0600
7/10	.700	700	0700
3/4	.750	750	0750
8/10	.800	800	0800

Fraction	Decimal	Amps	Bel FGNO[XXXX]
	1.0	1	1000
1-1/4	1.25	1.25	1250
	1.60	1.6	1600
	2.0	2	2000
2-1/2	2.5	2.5	2500
	3.0	3	3000
3-1/2	3.5	3.5	3500
	4.0	4	4000
	5.0	5	5000
	6.0	6	6000
	7.0	7	7000

Mechanical Dimensions

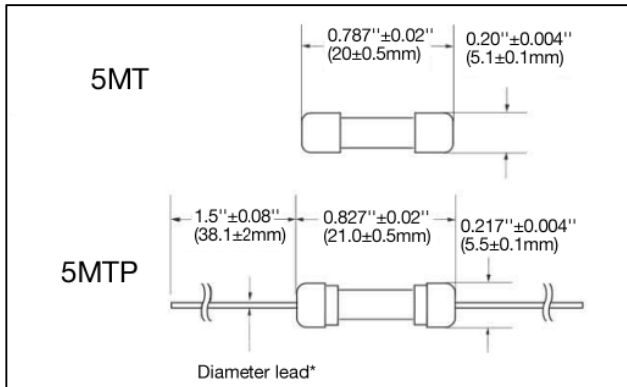

*Ratings 5A and less have 0.032" diameter lead;
 *Ratings 6A and above have 0.040" diameter lead.

Ordering Information

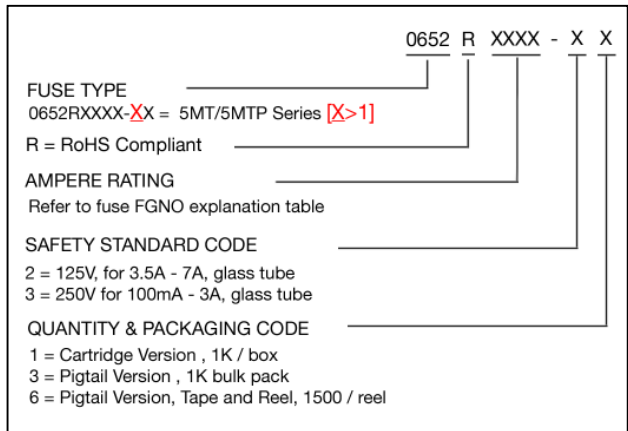

Packaging

Packaging Option	Packaging Specification	Quantity	Packaging Code	Inside Tape Spacing
Bulk	N/A	1000	33 / 21	N/A
Bulk (Pigtail Type)	N/A	1000	33 / 23	N/A
Tape & Reel, 10mm Pitch	EIA-296-F	1500	36 / 26	63



Specifications subject to change without notice

Bel Fuse Inc.
 206 Van Vorst Street
 Jersey City, NJ 07302 USA

+1 201.432.0463
 Bel.US.CS@belf.com
belfuse.com/circuit-protection