



proop

User Manual



Table Of Contents...

A) Operator Panel.....	6
A.1. Features.....	6
A.1.1. Features Graph And Design.....	6
A.1.2. Support Free type and Windows® Font.....	6
A.1.3. Support Remote Access.....	6
A.1.4. Project Upload/Download Via USB Host.....	6
A.1.5. Regional Formatting Format Support.....	6
A.1.6. User Friendly EMKO Macro.....	7
A.1.7. Internal Analog/Digital IO Port Support.....	7
A.1.8. Online/Offline Simulation Mode.....	7
A.1.9. Industry Standard Multiple Communication Network.....	7
A.2. PROOP Builder Setup.....	8
B) Screen Editor.....	10
B.1. Menu Bar.....	10
B.1.1. Project.....	11
B.1.1.1. Project Settings.....	12
B.1.2. Form.....	14
B.1.3. Edit.....	15
B.1.4. Tools.....	15
B.1.4.1. Uploads.....	16
B.1.4.2. Online Simulation.....	18
B.1.4.3. Image & Font Library.....	20
B.1.5. Options.....	22
B.1.5.1. Communication Settings.....	22
B.1.5.2. Datalog Setup.....	24
B.1.5.3. Alarm Setup.....	25
B.1.5.4. Recipe Editor.....	26

B.1.5.5. Recipe Data Editor.....	27
B.1.5.6. Language Editor.....	28
B.1.5.7. Macro Editing.....	31
B.2. Tool Bar.....	33
B.3. Side Bar.....	34
B.4. Element List.....	35
B.4.1. Show Data.....	36
B.4.2. Buttons.....	38
B.4.3. SVG Buttons.....	40
B.4.4. Data Entry.....	41
B.4.5. Gauges.....	43
B.4.6. DataLog.....	44
B.4.7. Others.....	45
B.4.8. Shapes.....	46
B.5. Properties List.....	47
B.5.1. Address.....	47
B.5.1.1. Address Watch.....	48
B.5.2. Data.....	49
B.5.3. Input.....	50
B.5.4. Value.....	51
B.5.5. General.....	51
B.5.6. Button.....	52
B.5.7. Special.....	53
B.5.8. Visual.....	59
B.5.9. Geometry.....	62
B.5.10. Set Value.....	62
B.5.11. Macro.....	62
B.5.12. Frame.....	63
B.5.13. Shape.....	64
B.5.14. Line.....	65

B.5.15. Pipe.....	66
B.5.16. Scale.....	66
B.5.17. Chart.....	67
B.6. Element Tree.....	69
C) Macro.....	70
C.1. Variable Types.....	70
C.2. Arithmetic Operators.....	71
C.3. Boolean Operators.....	73
C.4. Logical Operators.....	75
C.5. Others.....	78
C.6. Type Conversion.....	82
C.7. Macro Wizard.....	83
D) PROOP Connections.....	84
D.1. Models.....	84
D.2. View Panel.....	85
D.2.1. Pin Connections.....	88
D.2.1.1. Supply.....	88
D.2.1.2. COM4.....	88
D.2.2. Pin Connections in PROOP 7" Models.....	89
D.2.2.1. COM1.....	89
D.2.2.2. COM2-COM3.....	89
D.2.2.3. Digital Inputs/Outputs.....	90
D.2.3. Pin Connections PROOP 10" Models.....	91
D.2.3.1. COM1-COM2.....	91
D.2.3.2. COM3.....	91
D.2.3.3. Analog/Digital Inputs.....	92
D.2.3.4. Analog/Digital Outputs.....	93
D.2.4. Internal I/O Address Definitions.....	94
D.2.5. Internal Memory Address Definitions.....	94
D.3. Supported Communication Protocols.....	95

D.3.1. MODBUS Master Address Definitions.....	96
D.3.2. MODBUS Slave Address Definitions.....	97
E) PROOP Upgrade.....	98
F) HMI Settings.....	100
G) Defining System Settings by Addressing.....	102
G.1. Brightness.....	102
G.2. Buzzer.....	103
H) Create An Application.....	104
H.1. Create A New Project.....	105
H.2. Add A New Device.....	107
H.3. Add A New Page.....	109
H.4. Add An Element Tool And Edit Property List.....	109
H.4.1. Define Read / Write Address Of Element.....	110
H.4.2. Add An Image Of Element.....	112
H.4.3. Define States Of Element.....	115

A) Operator Panel

EMKO PROOP provides high speed vector based graphics with powerful Cortex A series CPU. Proop Builder software has user friendly design for rapid and easy development.

A.1. Features

A.1.1. Features Graph And Design

- More than 100 ready to use vector-based elements.
- Vector based image (SVG) support.
- BMP, GIF, JPG, JPEG, PNG, PBM, PGM, PPM, TIFF, XBM, XPM image format support.
- Improved graphics engine; Antialiasing, alphablending support

A.1.2. Support Free type and Windows® Font

Supports TrueType (TTF), PostScript Type1 (PFA/PFB), Bitmap Distribution Format (BDF), CID-keyed Type1, Compact Font Format (CFF), OpenType fonts, SFNT-based bitmap fonts, Portable Compiled Format (PCF), Microsoft Windows Font File Format (Windows FNT), Portable Font Resource (PFR), Type 42 (limited support) font types.

A.1.3. Support Remote Access

Remote control can performed by the internal VNC protocol.

A.1.4. Project Upload/Download Via USB Host

Project upload or download can do in a short time by the high speed data transfer USB 2.0 Port

A.1.5. Regional Formatting Format Support

The time, date, and number formats are sensitive to regional settings.

A.1.6. User Friendly EMKO Macro

Emko Macro is designed to perform custom control functions and calculations with internal I/O and communication devices.

Macro is described under the heading 'Macro'.

A.1.7. Internal Analog/Digital IO Port Support

The user can control the data with the macro and visual elements.

A.1.8. Online/Offline Simulation Mode

Compiled program is simulated in the PC environment without PROOP device.

A.1.9. Industry Standard Multiple Communication Network

- Communication interface: RS232, RS422, RS485, Ethernet
- Communication protocols: MODBUS ASCII, RTU, TCP/IP.
- Siemens S7-200/300/400/1200 PLC protocol support.
- Supported PLC protocols: Siemens PPI, MPI, ISO over TCP

A.2. PROOP Builder Setup

Minimum system requirements for Proop Builder Software install:

- 1GHz or greater CPU
- 1GB RAM
- 2GB Hard Disk (least 500 MB of free memory)
- RJ45 Ethernet Network Cable
- USB 1.1 Port Input
- Windows XP, Windows Vista, Windows 7, Windows 8, Windows 8.1, Windows 10 operating systems.

Please, follow the steps on the below for installation.

Step 1:

It is strongly recommended that before proceeding, you ensure that no other Windows programs are running.

Step 2:

Run the Proop Builder setup file “Proop Builder VX.X.X Setup.exe” to start the installation process.

Step 3:

Continue the installation by following the dialog boxes on the screen and choose where to install. After selecting the default folder, click '**Next**'. If necessary, you can retrieve individual steps with '**Back**' option.

Program will automatically be installed in the default folder.

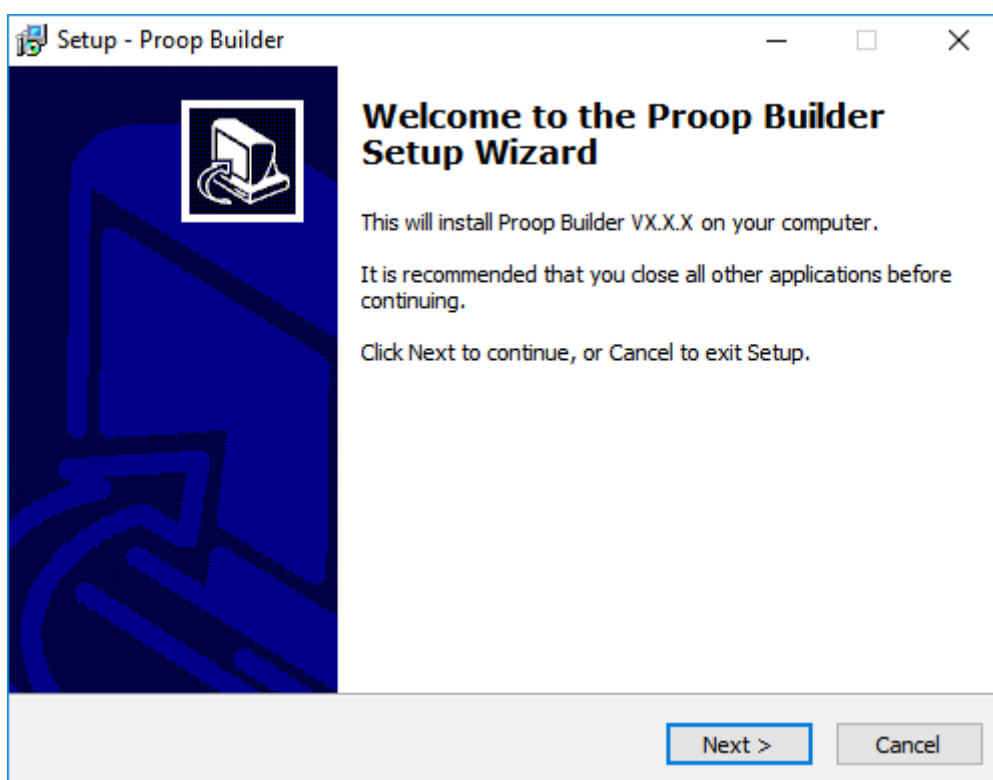

Picture 1: Setup

Step 4:

Please click the "Windows Start>Programs>Proop Builder" shortcut to start the application.

B) Screen Editor

Editor contains six sections; tool and sidebar, elements and property list, element tree.

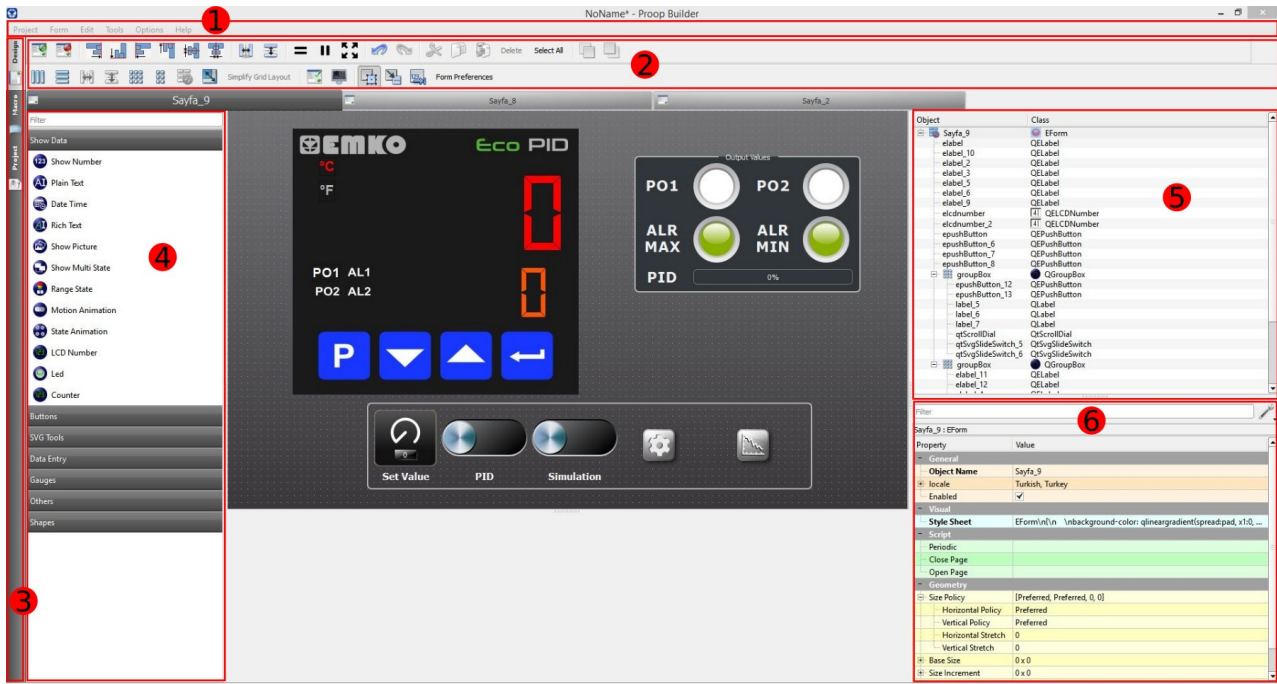

Picture 2: Screen Editor

B.1. Menu Bar

The menu bar contains Project, Form, Edit, Tools, Options and Help sections as the picture below.

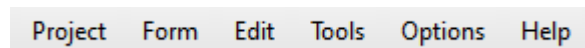

Picture 3: Menu Bar

B.1.1. Project

Menu with editing options related to the project. There are sub menus as below.

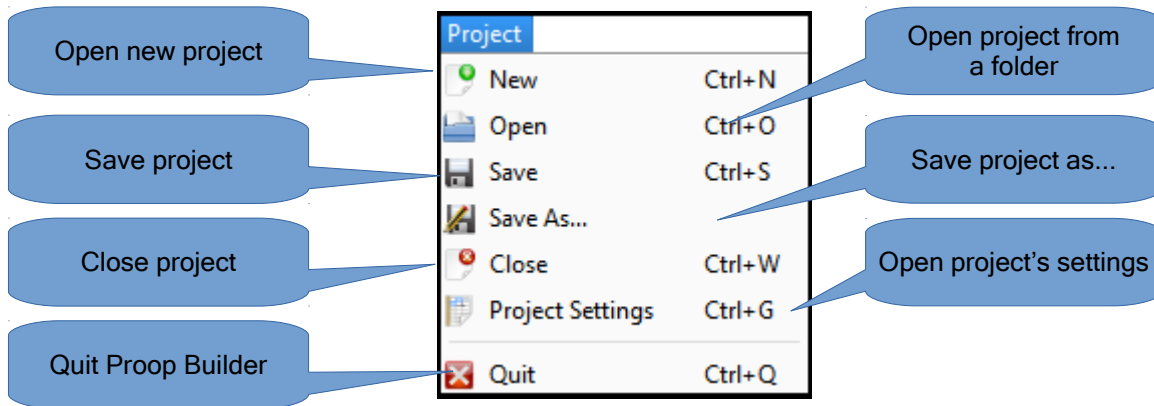

Picture 4: Project

B.1.1.1. Project Settings

Project properties and settings that are active on this page are edited.

The properties and settings of the active project are edited.

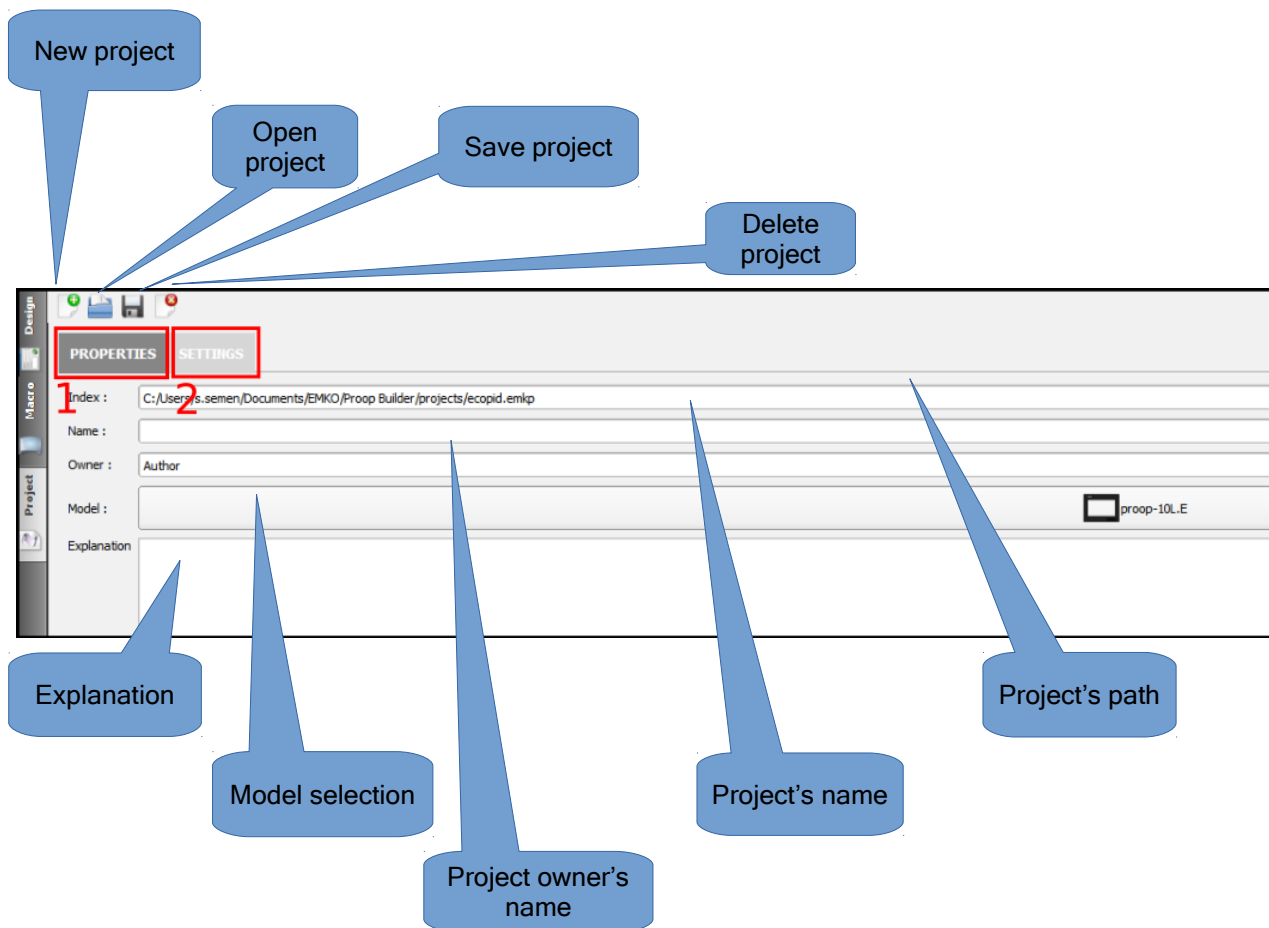

Picture 5: Project Settings

When you click on **“Properties”** sections in the field 1, form screen appears. In the picture above contains field descriptions.

Model Selection: Lists all Proop models with specifications and use to select the target model.

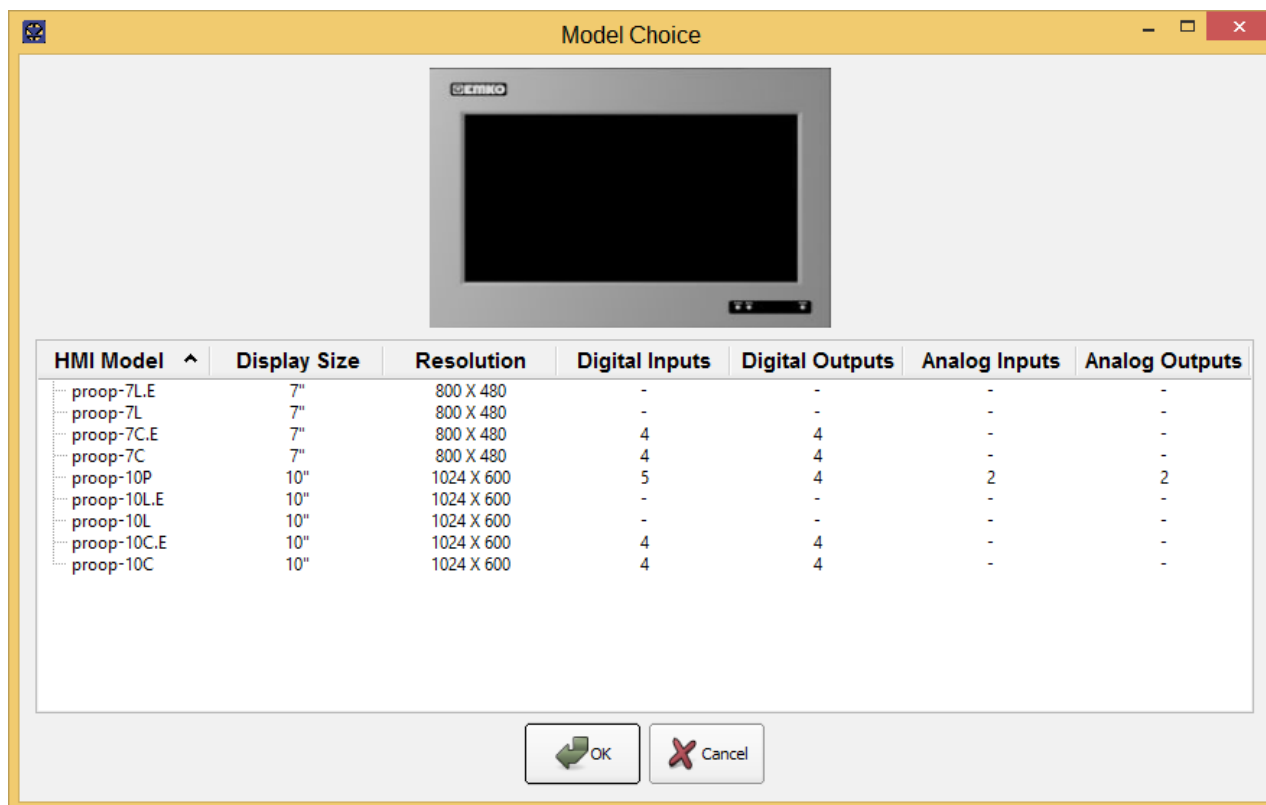

Picture 6: Model Selection

Click on the **“Settings”** section in the number 2 and the settings form screen appears. Here, frequency of macro work in the project is arranged.

Main Macro: A master macro is written for a project, and this macro is continuous with the specified period.

Timer Macro: When the program starts to run, the timer macro runs.

Macro, runs continuously at the specified period. A timer macro is written for a project.

Beginning Macro: Runs once when the project is opened.

The usage of macro is described under the heading **“Macro”** title.

The desired macro is selected and edited as shown below.

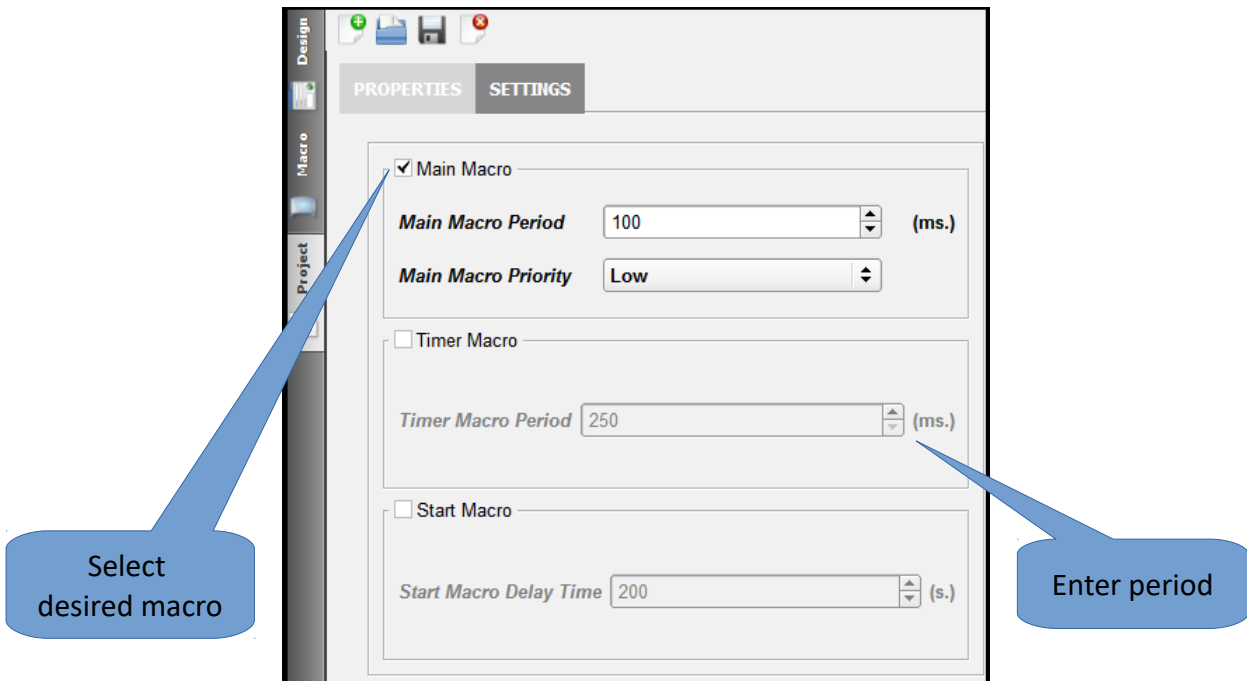

Picture 7: Project->Settings

B.1.2. Form

A menu has with options for the form. There are sub menus as below.

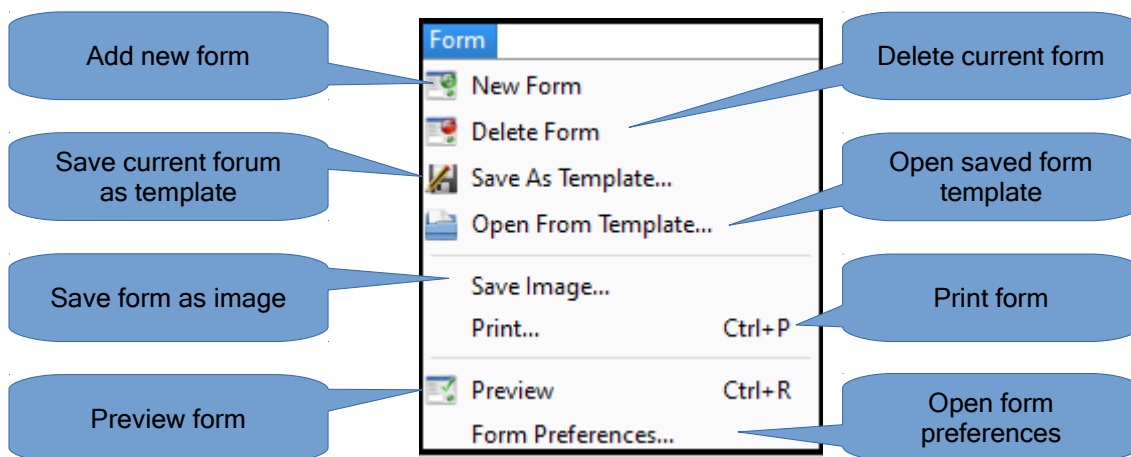

Picture 8: Menu Bar->Form

B.1.3. Edit

Contains regulations about the elements in the form.

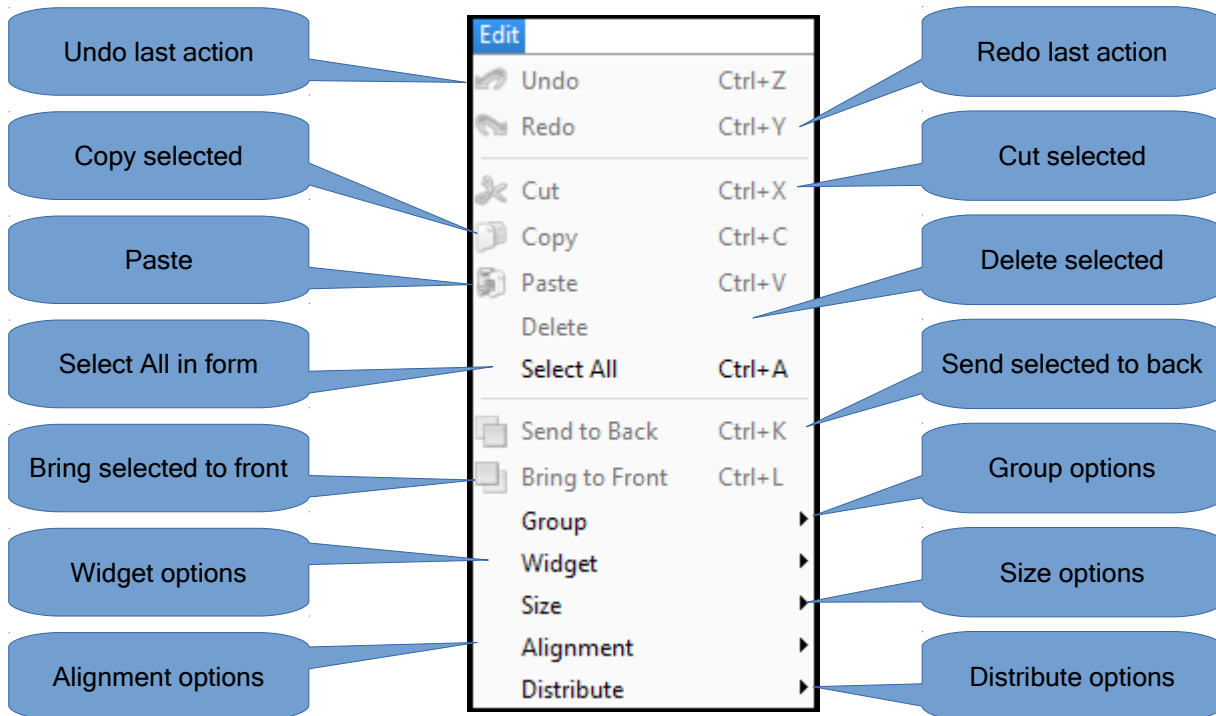

Picture 9: Menu Bar->Edit

B.1.4. Tools

Contains general tools related to the project. There are sub menus as below.

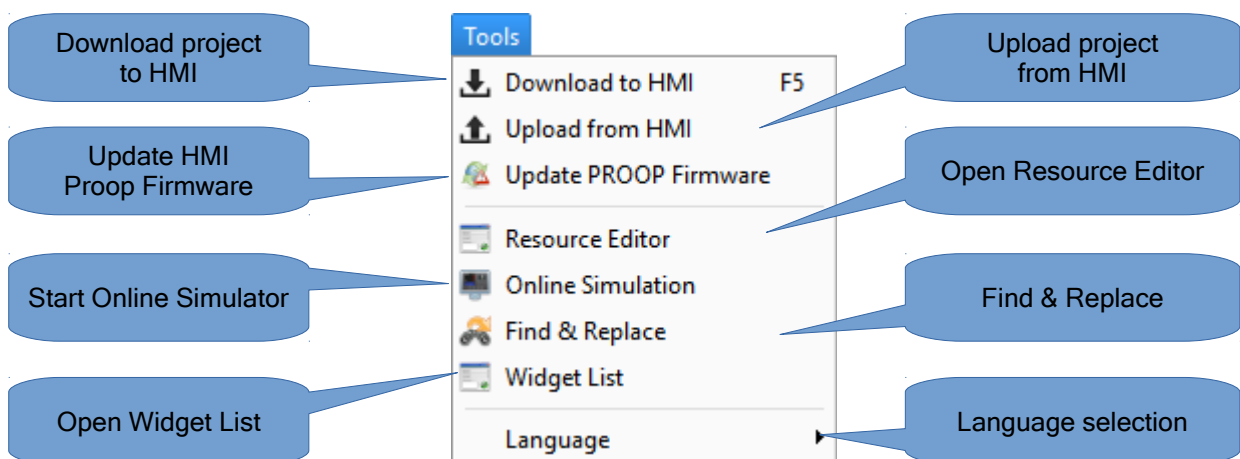

Picture 10: Menu Bar->Tools

B.1.4.1. Uploads

To upload the project files you can use USB Cable or USB disc.

Project Upload Via Port

- To upload the project to the device, plug the USB cable into the device.
- Click to '**Tools Bar>Download**' or press '**F5**' on keyboard.
- Click on the icon in the bottom left of the Proop Builder Program. 

Uploading Project with USB Memory

- To upload the project into the device, create a folder named 'emko' or 'proop' in your USB memory

Example upload folder: "G:\proop", "G:\emko"

- Copy the project file (*.emkp) into the upload folder.
- If your project contains resource files please copy the compiled resource files(*.rcc) to the upload folder. You can find the compiled files near your resource library.

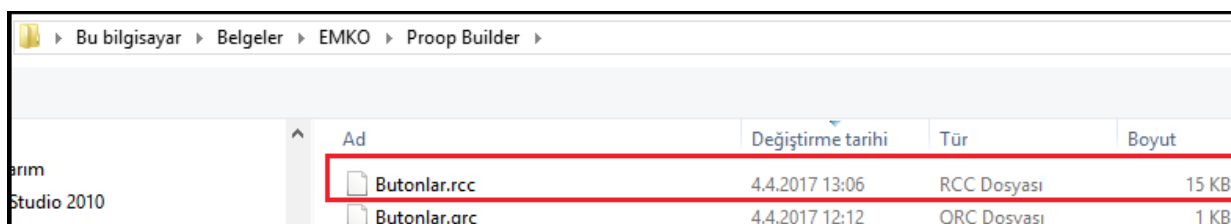

Picture 11: Proop Builder Folder

- The files that should be located in the folder named Proop are as follows .

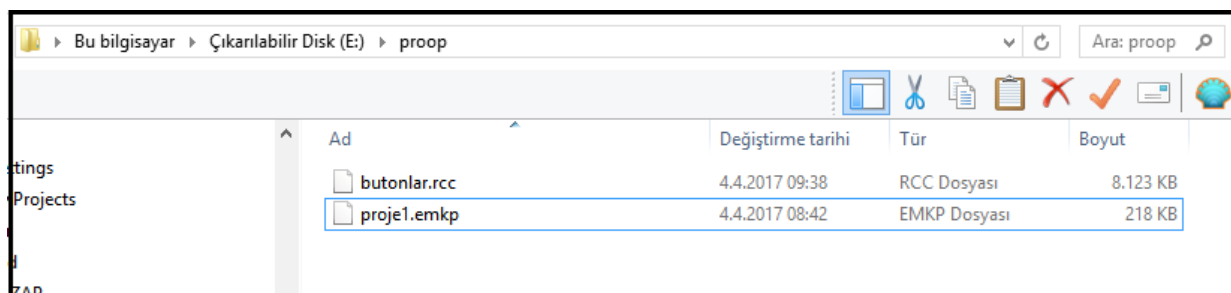

Picture 12:Proop Folder

- Unplug the USB after copying to USB memory is finished.
- Plug it into the USB port on the back of the device.
- When you switch off the power and switch again, you can follow the project installation status via the device screen.

```

Please wait: booting...
Kernel      : 4.1.20-rt22-fslc+g445b81a
Application : #1.0
Update      : Fri Mar 31 15:07:20 EEST 2017
Update <sh> started, please wait...
Update successful!!!

```

Picture 13:Project Upload

B.1.4.2. Online Simulation

Designed pages and macro codes can be simulated in the PC environment.

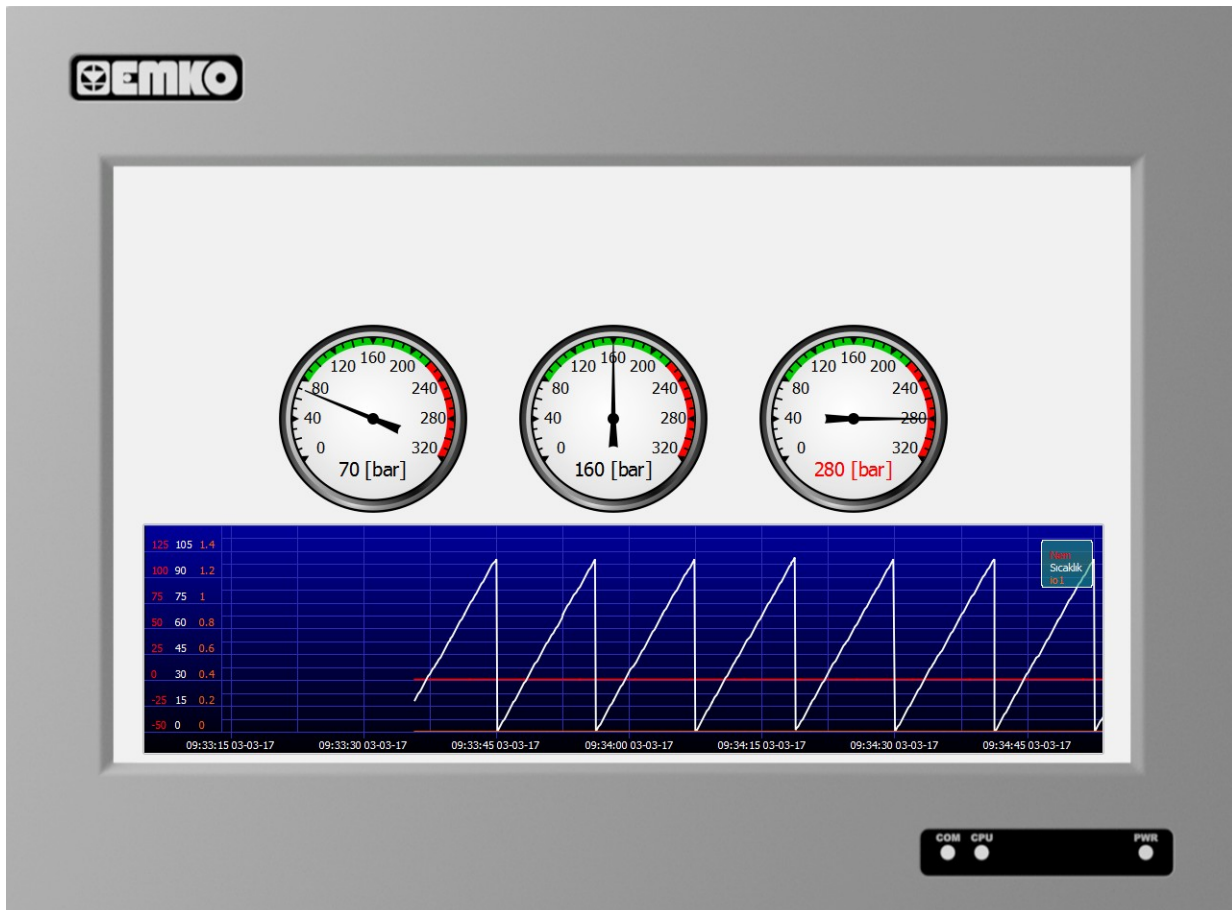

Picture 14: Menu Bar->Tools->Online Simulation

When you click the right mouse button the pop-up screen appears.

You can navigate between pages and finish the simulation with these shortcuts.



Picture 15: Menu Bar->Tools->Online Simulation->Options

B.1.4.3. Image & Font Library

Used in the program Picture, animations and font types listed here.

User can be create, edit or delete custom image library and user can load and use the font type that it wants to use in the project in the picture & font library.

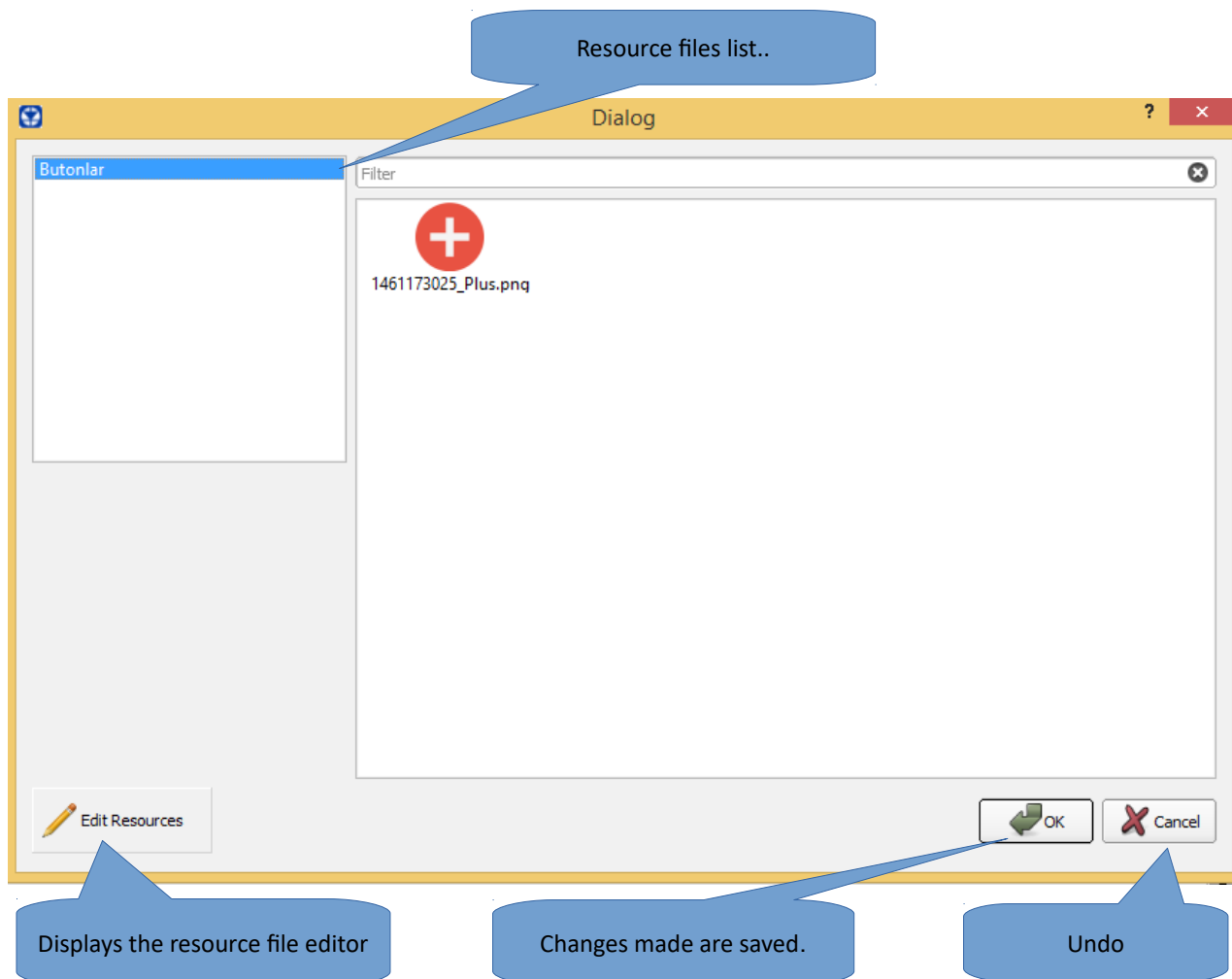

Picture 16:Resource Editor

Click the '**Edit Resource**' button to edit the image files.

The created or existing image files are managed from here.

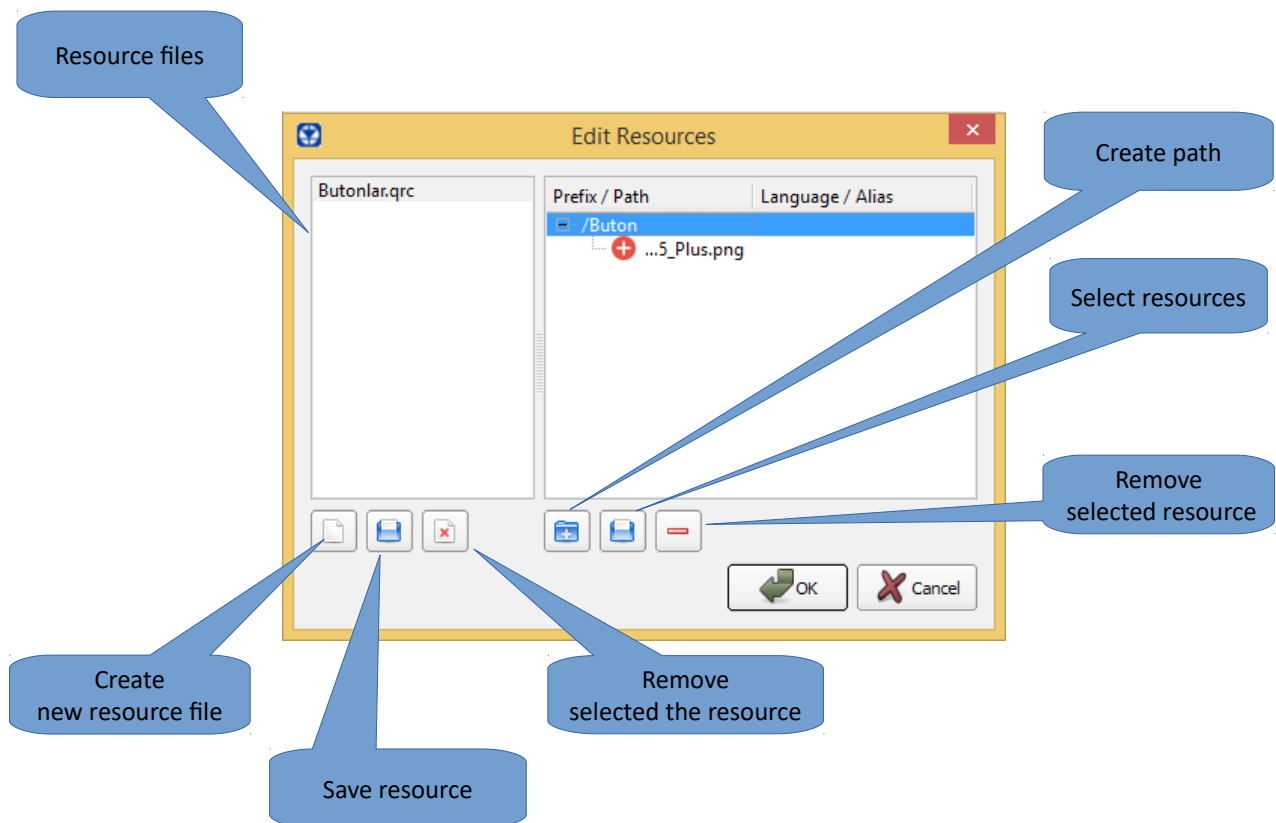

Picture 17: Menu Bar->Edit->Resource Editor

B.1.5. Options

Contains a project options. There are sub menus as below

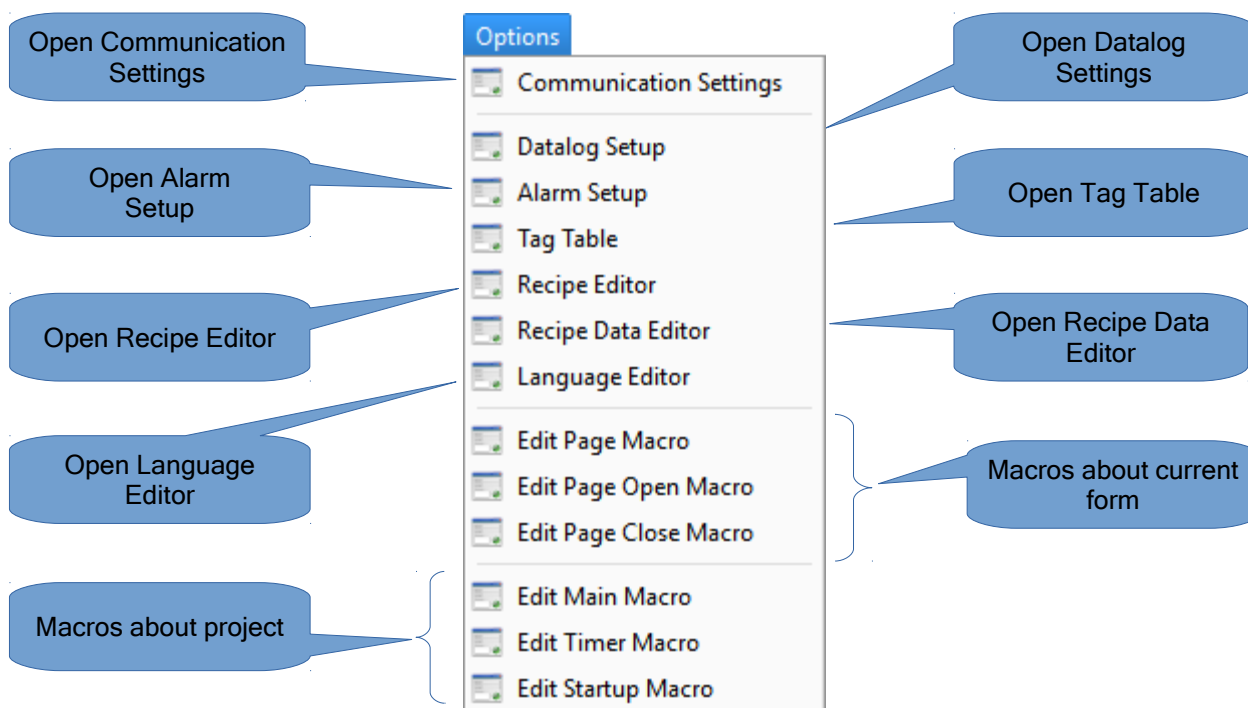

Picture 18: Menu bar->Options

B.1.5.1. Communication Settings

Window contains communication settings of HMI connected device.

The field number 1; Selected COM port.

The field number 2; Lists added devices into the selected COM port.

The field number 3, Selected COM port communication settings. The simulation port field in the serial settings specifies the PC comport to be used during online simulation.

The field number 4, contains device information fields with modification.

The field number 5, contains additional options for connection.

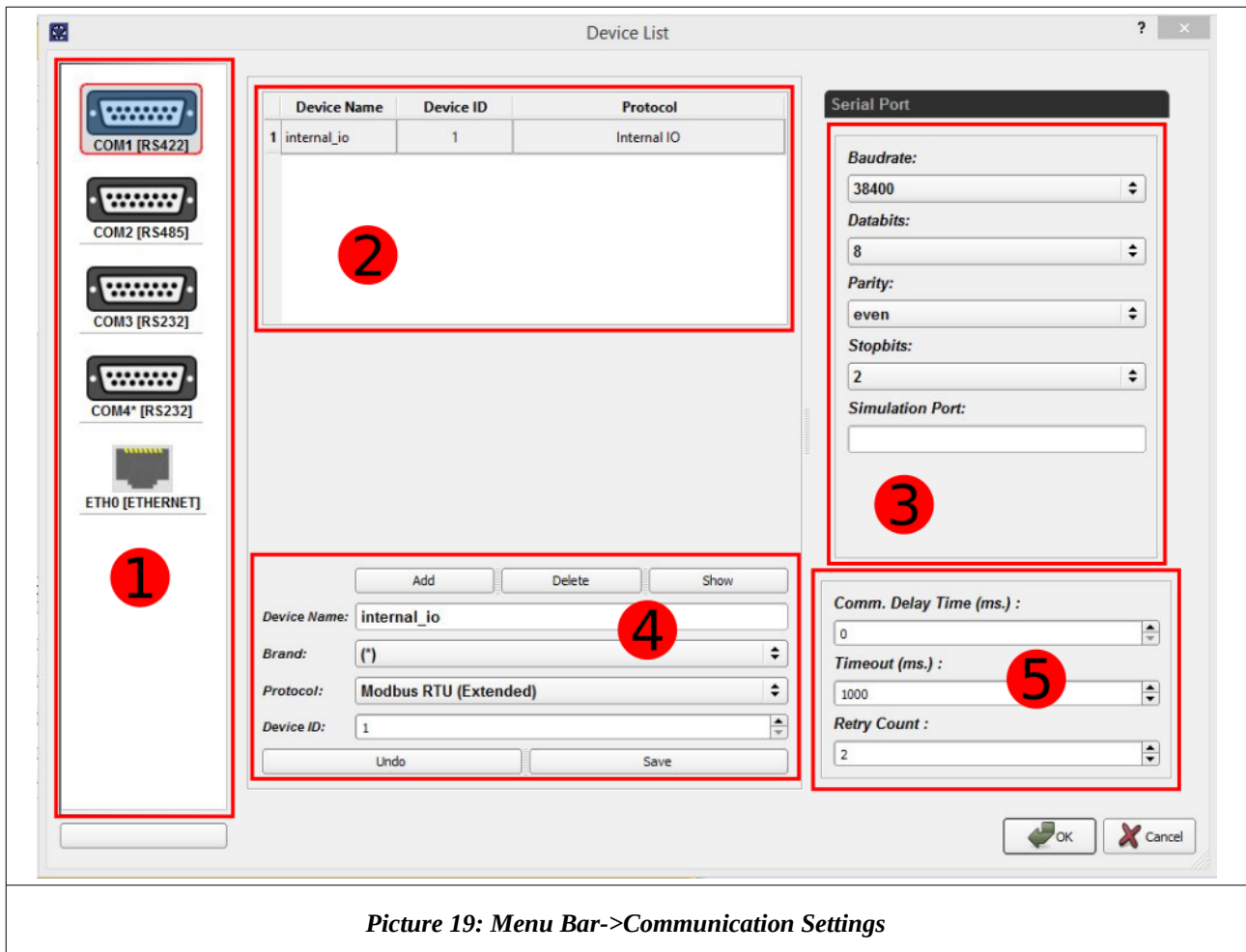

To Add a Device;

- Select the connected point of the device from area 1
- Enter the device information field 4 and click the add button.
- Lists the added device in the second area device list and select the device.
- Arrange the serial port settings in area 3.
- Finally, Enter the communication delay time from the 5th area.
- Click the save button, after making changes to the devices in the device list.

B.1.5.2. Datalog Setup

Data is read from given address and saved to csv file. Setup about this operation can be configured in Datalog Setup.

“Channel Name” is given name to log.

“Storage Type” shows where logs are saved.

“Group Name” is given name to log in file.

“Read Address” is data’s address.

“Data Type” is type of read data.

“Visual Format” shows data’s decimal type.

“Retention Time” shows data’s retention period.

“Sample Period” shows data’s read time.

The screenshot shows a dialog box titled "Datalog Properties". At the top, there is a table with the following columns: Name, Address, Type, Sample Period, and Group Name. The table is currently empty. Below the table, there are several input fields:

- Channel Name:** A text input field.
- Storage Type:** A dropdown menu.
- Group Name:** A text input field.
- Read Address:** A text input field with a browse button (three dots) to its right.
- Data Type:** A dropdown menu.
- Visual Format:** A dropdown menu showing the value "12345".
- Retention Time (days):** A spin box showing the value "1".
- Sample Period (seconds):** A spin box showing the value "1".

At the bottom of the dialog, there are four buttons: "ADD", "DELETE", "OK", and "CANCEL".

Picture 20: Menu Bar->Options->Datalog Setup

B.1.5.3. Alarm Setup

Data is read from given address and compared according to comparison and as result alarm may rise. Setup about alarms can be configured in Alarm Setup.

“Max. Internal Records” is number of record as internal.

“Read Address” is value’s address and comparison condition.

“Alarm Text” is shown alarm text.

“Video” can be played when alarm rises.

“Alarm Color” is background color of alarm.

“Storage Type” is selection of store type. CVS file can be saved to usb.

“Group Name” is name in file.

“Data Type” is type of read value.

“Visual Format” shows decimal type of value.

The screenshot shows the 'Alarm Properties' dialog box. At the top, there is a spin box for 'Max. Internal Records' set to 10000. Below this is a table with columns 'Name', 'Address', 'Type', and 'Group Name'. The table is currently empty. Underneath the table are several configuration fields: 'Read Address' with a text input and a browse button, and a spin box set to 0,000; 'Alarm Text' with a text input; 'Video' with a text input and a browse button; 'Alarm Color' with a color picker showing black; 'Storage Type' with a spin box; 'Group Name' with a text input; 'Data Type' with a spin box; and 'Visual Format' with a spin box set to 12345. At the bottom of the dialog are four buttons: 'ADD', 'DELETE', 'OK', and 'CANCEL'.

Picture 21: Menu Bar->Options->Alarm Setup

B.1.5.4. Recipe Editor

In this editor, new recipe and it's items can be added and configured.

“Address” is item’s address.

“Item Name” is given name to item.

“Data Type” is item’s data type.

“Data Size” is item’s data size.

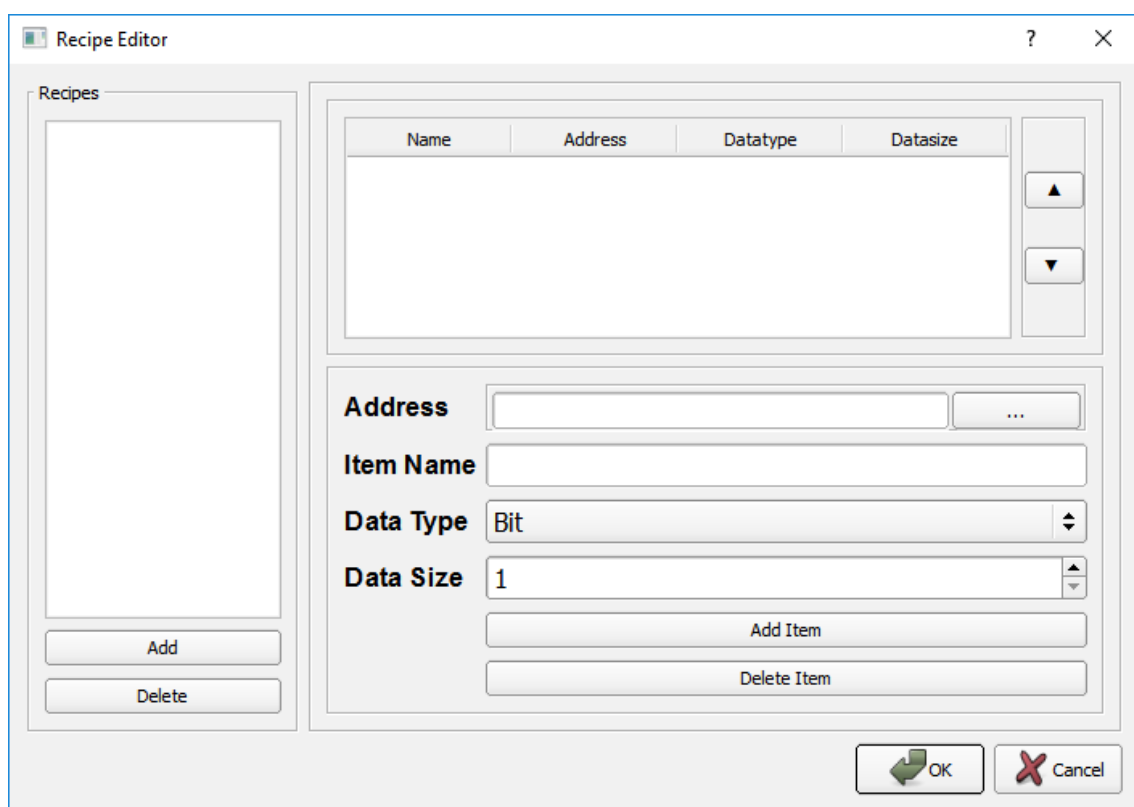

Picture 22: Menu Bar → Options → Recipe Editor

B.1.5.5. Recipe Data Editor

In this editor, programs can be derived with prepared recipe.

“Add Item” is used to add a new item and under “title”, a name can be entered and values can be assigned to recipe’s items.

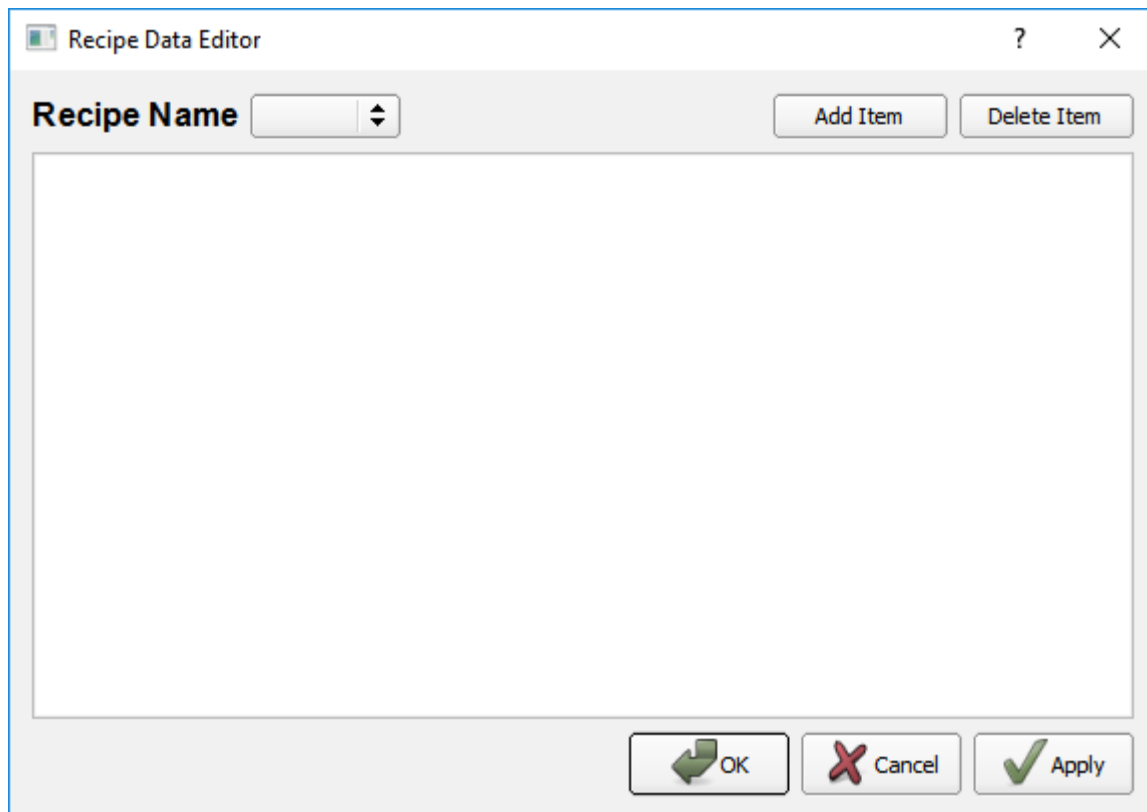

Picture 23: Menu Bar → Options → Recipe Data Editor

B.1.5.6. Language Editor

This editor helps user for language types and translations. Labels can be assigned by language to elements in forms and labels' fonts can be changed. Translations can be exported or imported as Excel file.

Languages can be added and its' fonts can be changed in Languages tab.

After adding language, Text Editor tab should be configured.

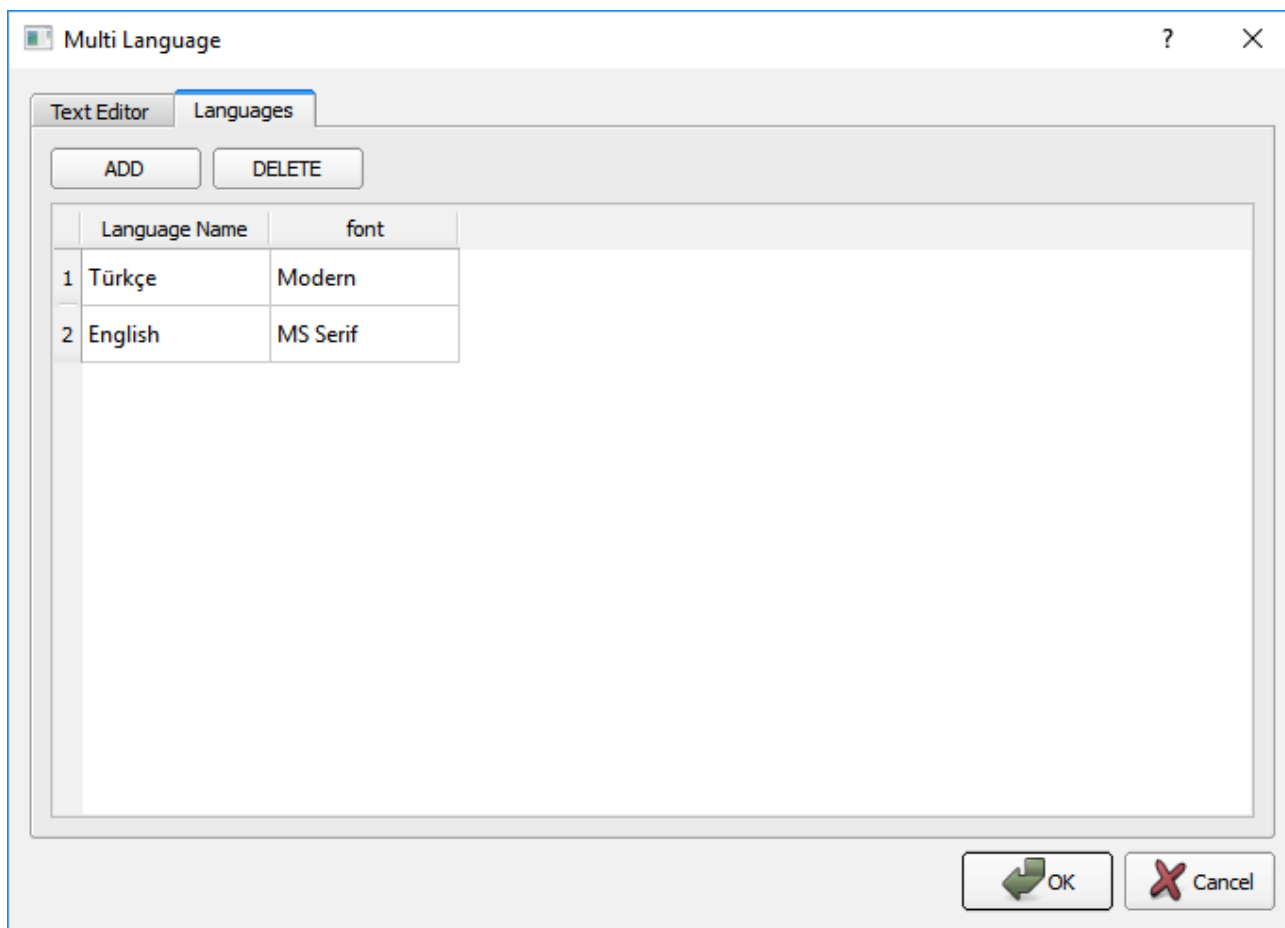

Picture 24: Menu Bar → Options → Language Editor → Languages

In Text Editor, elements are listed and labels are translated by added languages.

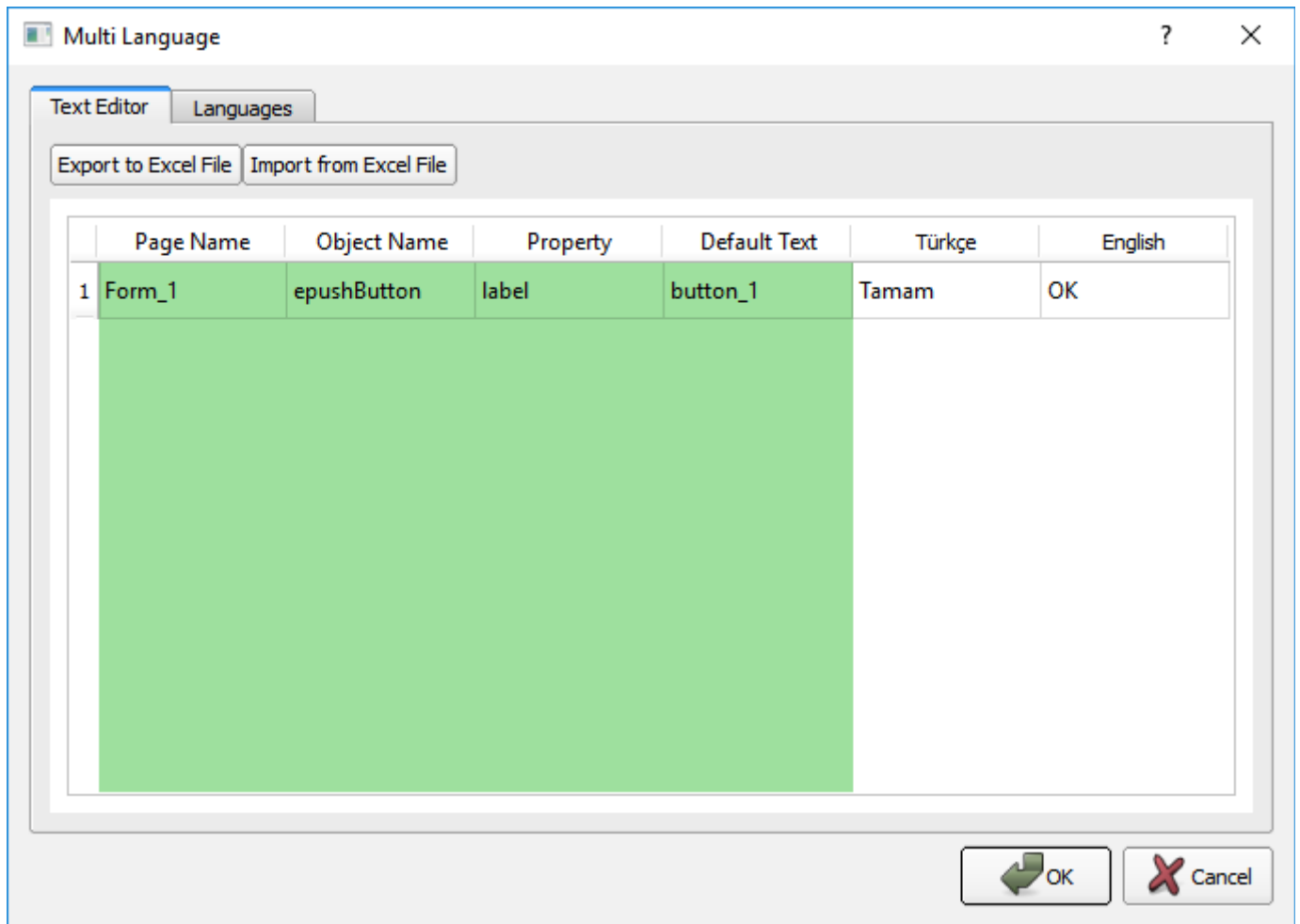

Picture 25: Menu Bar → Options → Language Editor → Languages

After adding languages and translations, those languages are listed under internal settings and language menu. For example, a button configurations is shown here and with this button, items' labels are going to be English.

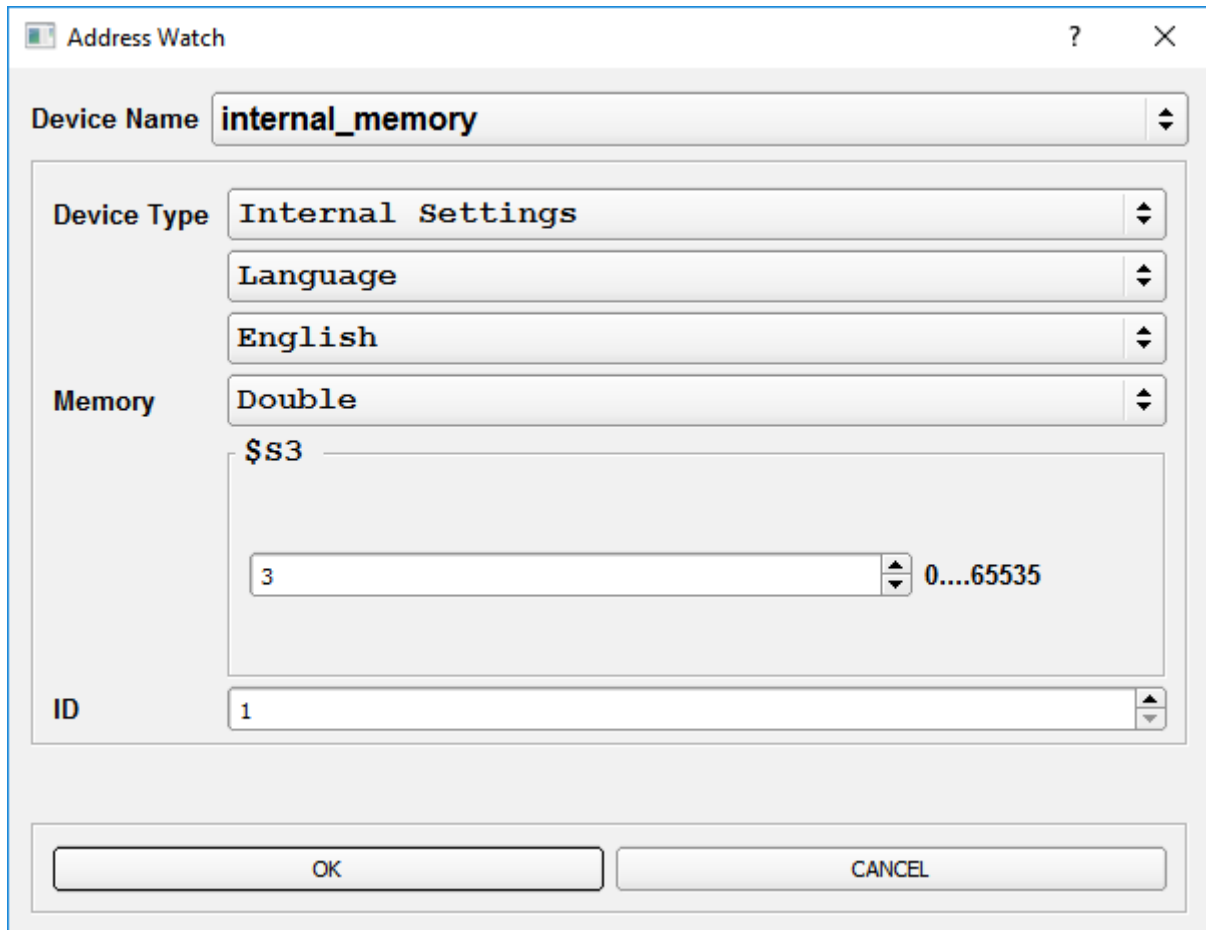

Picture 26: Menu Bar → Options → Language Editor (Language Assignments)

B.1.5.7. Macro Editing

Macro language is added for user convenience. The generated macros can be exported or macros can be transferred from the outside.

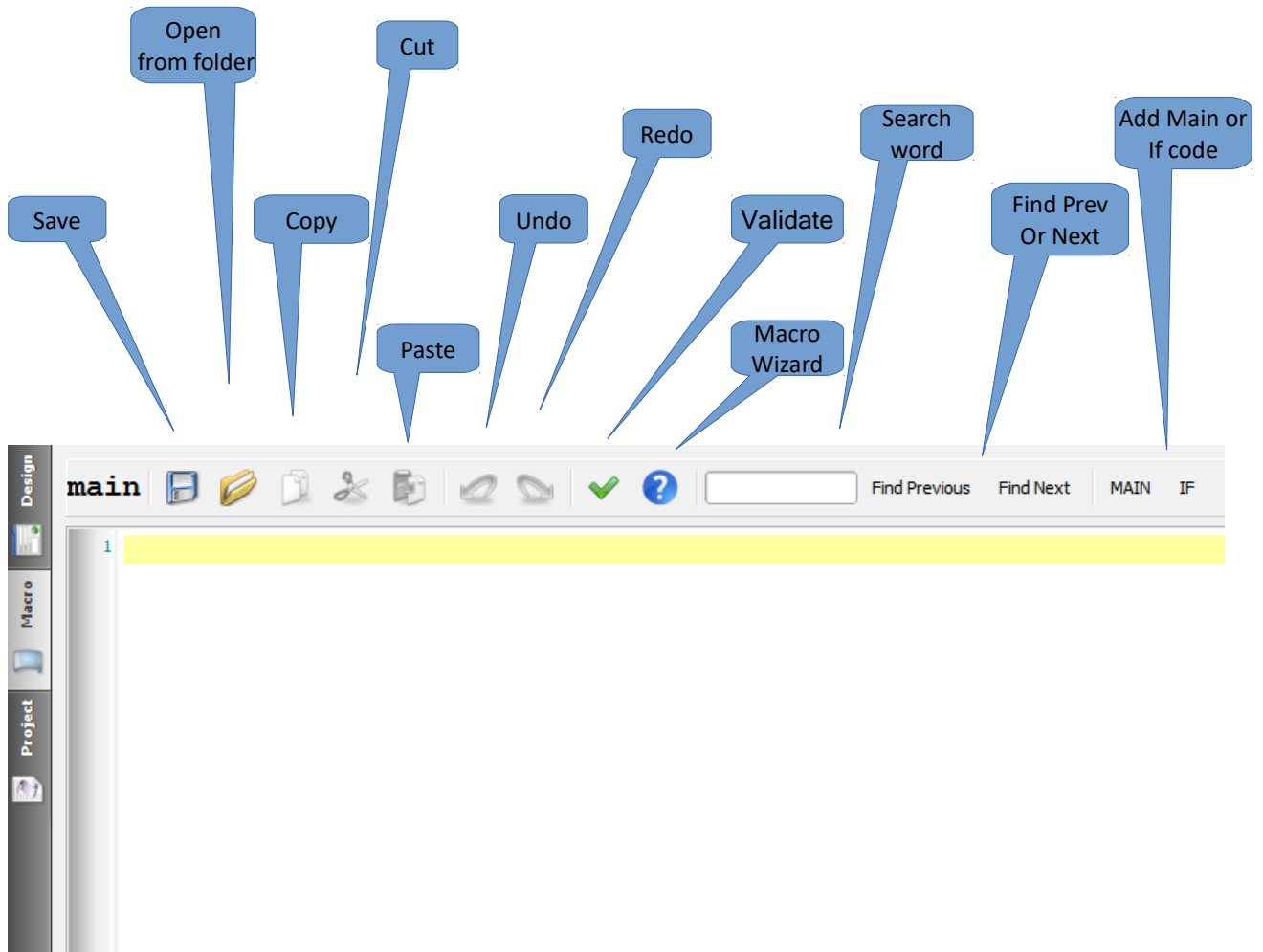

Picture 27: Menu Bar->Options->Edit Page Macro

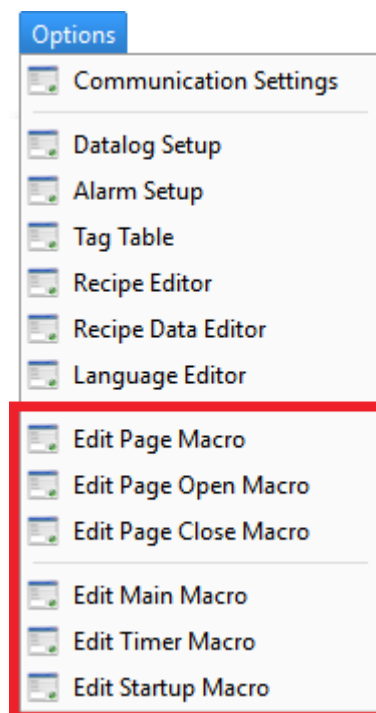

Picture 28: Menu Bar → Options
(Macro)

Macro shortcuts in Options menu

Edit Page Macro: Current page's macro codes can be edited.

Edit Page Open Macro: Current page's macro codes while opening can be edited.

Edit Page Close Macro: Current page's macro codes while closing can be edited.

Edit Main Macro: Project's main macro codes can be edited.

Edit Timer Macro: Project's timer macro codes can be edited.

Edit Startup Macro: Project's startup macro codes can be edited.

B.2. Tool Bar

Toolbar contains tools for project. The following tools.



Picture 29: Tool Bar->Form

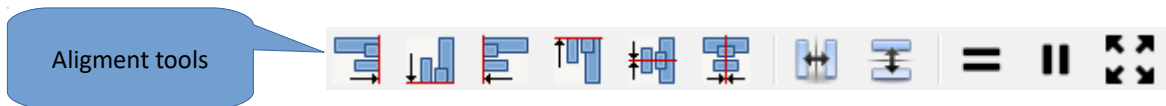

Picture 30: Tool Bar->Alignment

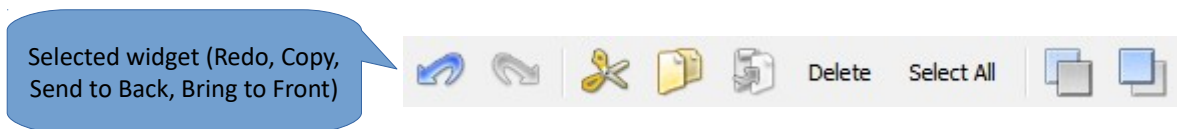

Picture 31: Tool Bar->Selected Widget



Picture 32: Tool Bar-> Group

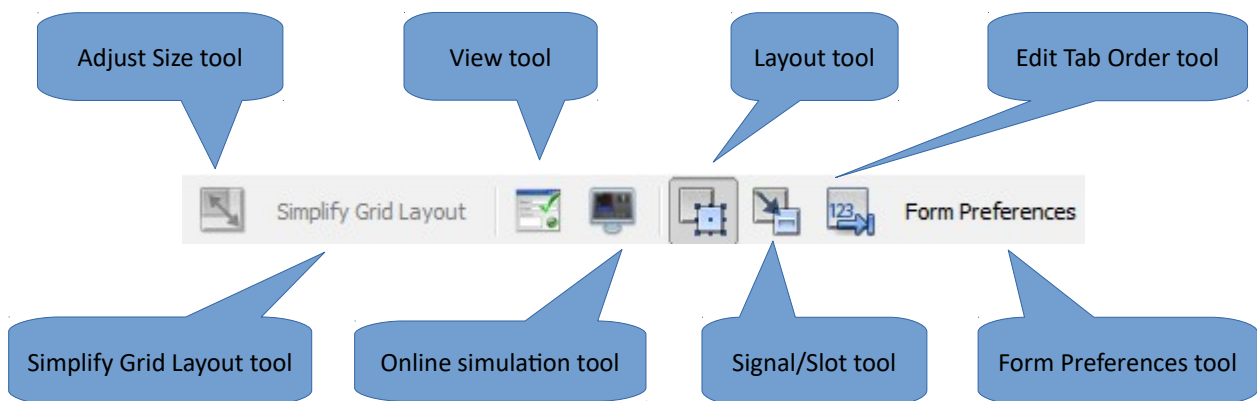

Picture 33: Tool Bar

B.3. Side Bar

Sidebar is located to the left of the screen editor.

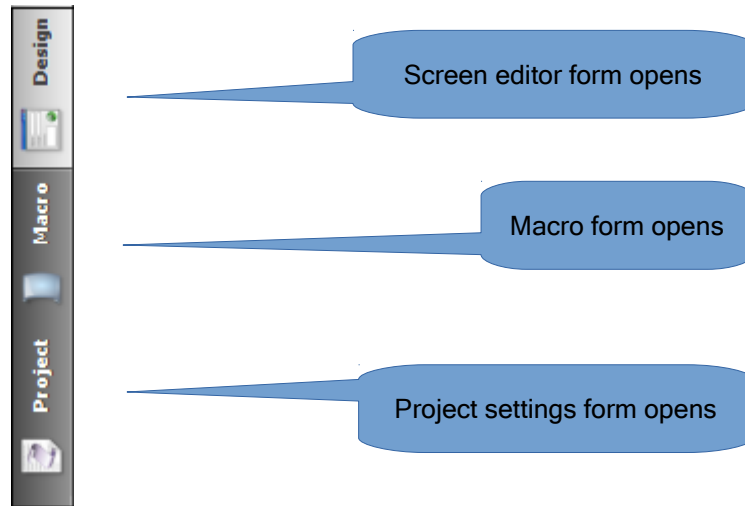

Picture 34: Side Bar

B.4. Element List

The elements that are available on the form page list.

To use can the element tool;

- Select to the element tool.
- Hold down the left button of the mouse to drag the selected object to the form and release.
- Edit the settings using the properties table.

Element tool can search and can find from '**Filter**' field.

Element tools consist of 5 parts.

- Show Data
- Buttons
- SVG Buttons
- Data Entry
- Gauges
- Other
- Shapes

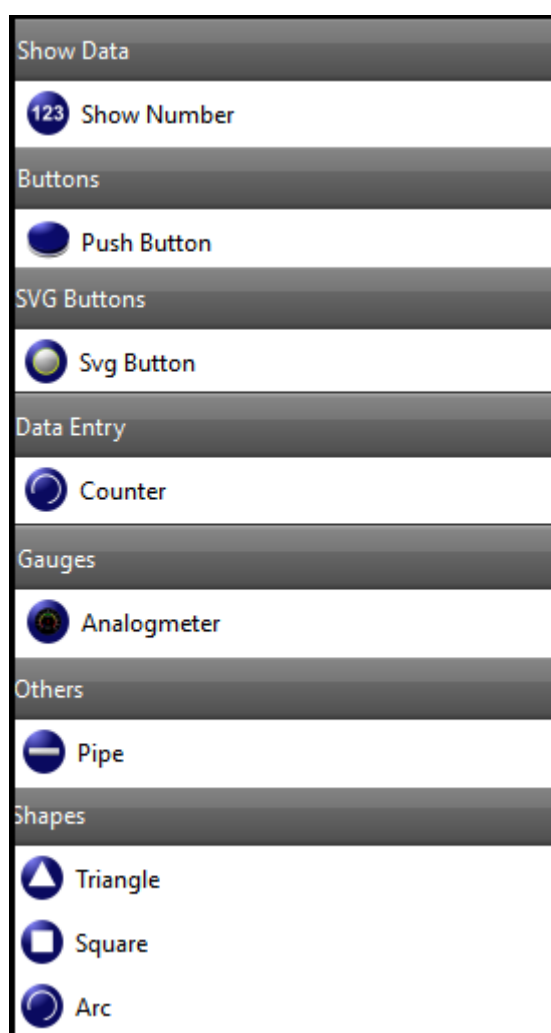

Picture 35: Element List

B.4.1. Show Data

The show data section can be use in the property, when the user want to display the a data, image, number or state.

Buttons divided into functions such as button type, status type, address function and page functions.

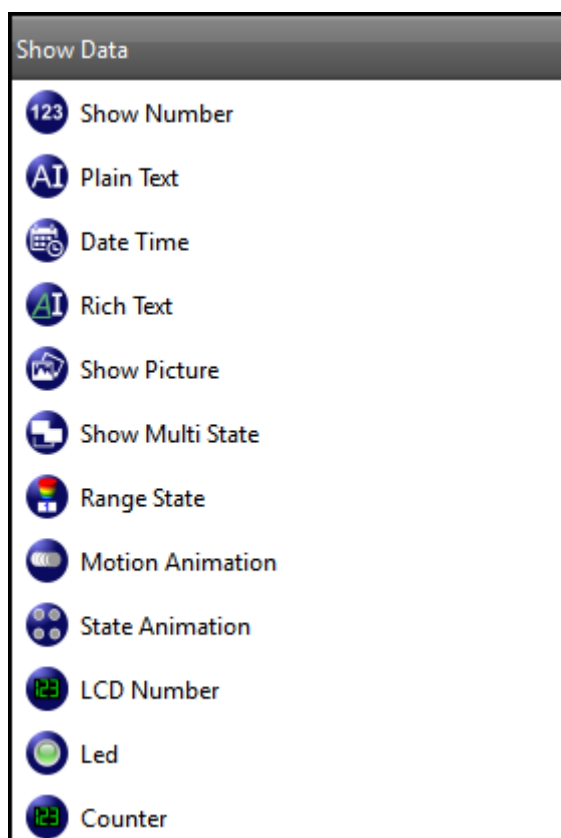

Picture 36: Show Data











Icon	Name	Function
	Show Number	Reads the specified address and display it as a number.
	Plain Text	Displays a text value on the form.
	Date/Time	Displays the date and time on the form.
	Rich Text	Displays a rich text on the form.
	Show Picture	Displays images the selected form in resource.
	Show Multi State	In the editor, displays the different values according to each state.
	Show Range	Displays the different values according to each range.
	Motion Animation	To use the motion animation, create more than one state. Set the desired field from property list for all status.
	State Animation	The state animation is displayed.
	Led	The color change is displayed according to the state of read address value
	Counter	The increase value or decrease value is displayed between the minimum and maximum value.









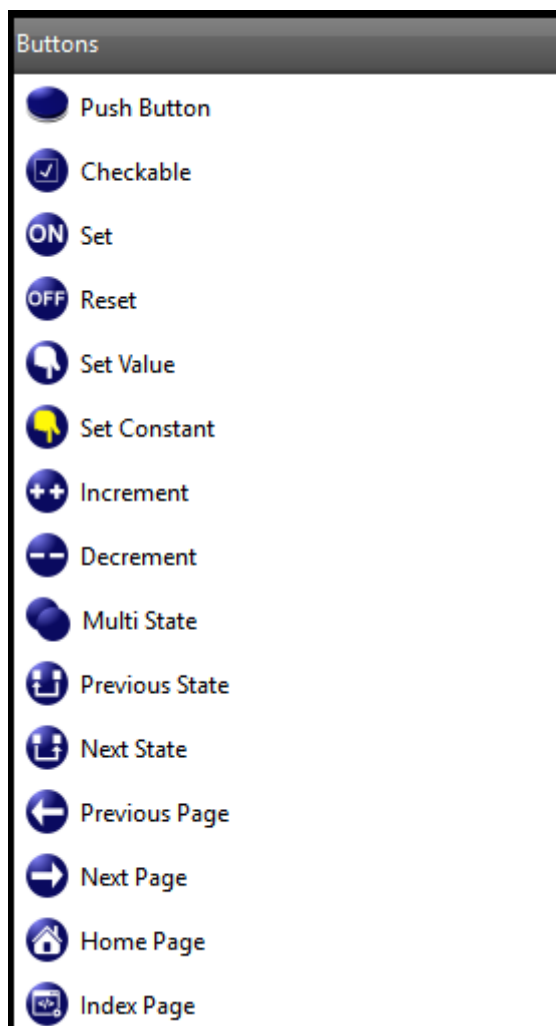





Table 1: Show Data

B.4.2. Buttons

Buttons divided into functions such as button type, status type, address function and page functions



Picture 37: Buttons

Icon	Name	Function
	Push Buton	When the push button is pressed, the state of address is ON and when the button is released, it is OFF.
	Checkable	When the push button is pressed, the state of address is ON and when the button is released, it is OFF.
	Set Buton	When set button is pressed, the state of the address is ON.
	Reset Buton	When set button is pressed, the state of the address is OFF.
	Set Value	When the button is pressed, the entered value will set at the defined address.
	Set Constant	When the button is pressed, the constant value will set at the defined address.
	Increment	When the button is pressed, a constant value will add to the value at the defined address. Then defined address will set added new value To define the constant value, go to “constant value field” in the set value section from property list.
	Decrement	When the button is pressed, fixed number is subtracted from the address value.
	Multi State	When the button is pressed, it moves to the next state or previous state. States are edited in the settings section.
	Previous State	When the button is pressed, it moves to the previous state.
	Next State	When the button is pressed, it moves to the next state.
	Previous Page	When the button is pressed, previous page is displayed.
	Next Page	When the button is pressed, next page is displayed.
	Home Page	When the button is pressed, home page is displayed.
	Go to Page	When the button is pressed, the page specified in the page index is displayed.

B.4.3. SVG Buttons

Svg buttons have the same function as the buttons and are named differently by the images.



Picture 38: SVG Buttons





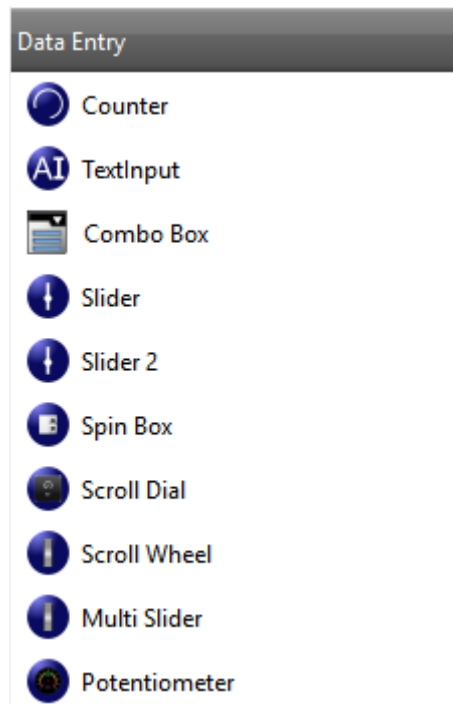

Icon	Name	Function
	SVG Button, SVG Button 2, SVG Button 3	It functions the same as the push button.
	Switch1, Switch2, Switch3, Switch4	It functions the same as the checkable.
	Multi Button	Up-down, left-right or center button functions can be used with one element.

B.4.4. Data Entry

The value change in the address is displayed on the screen.



Picture 39: Data Entry



Icon	Name	Function
	Counter	Counter increases and decreases between the minimum and maximum values with buttons.
	Text Input	Text can be entered with this element.
	Combo Box	This is drop down list element.
	Counter, SpinBox	Determine the desired amount of increase and decrease between the minimum and maximum values is displayed.
	Slider, Slider 2, Scroll Dial	The desired amount of increase and decrease between the minimum and maximum values is displayed.
	Scroll Wheel, Multi Slider	It functions the same as the slider.
	Potentiometer	It functions the same as the analog meter.

B.4.5. Gauges

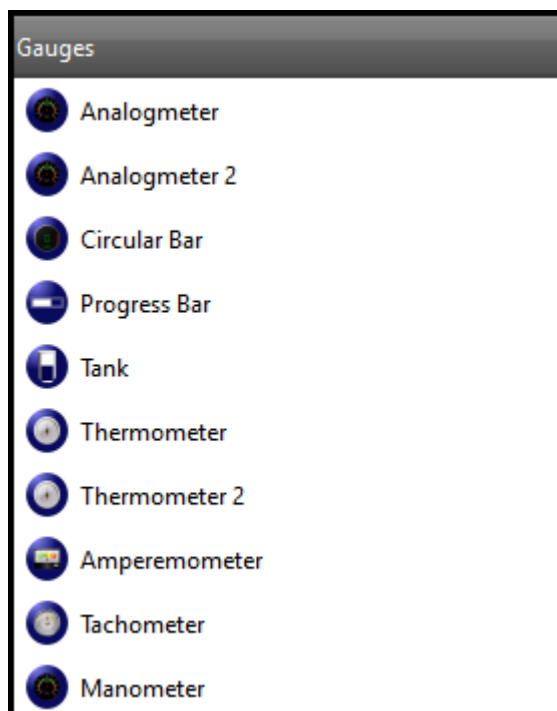
Change value displays is displayed with using data entry elements.



Picture 40: Gauges

Icon	Name	Function
	Analogmeter, Analogmeter 2, Circular Bar	Determine the desired amount of increase or decrease between minimum and maximum values is displayed. In the settings sections, upper limit and lower limit of value, the scala and the needle color are set.
	Progress Bar, Tank	The change of the value at reading address is displayed. Top limit and bottom limit can be colored from settings sections.
	Thermometer, Amperemometer, Tachometre, Manometer	It functions the same as the analogmeter.

B.4.6. DataLog

List and charts help to show logged data.

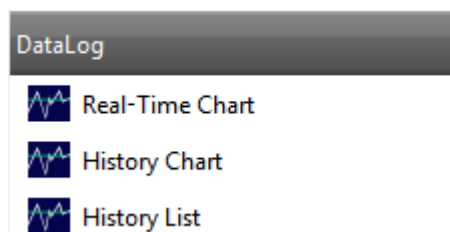

Picture 41: Element List->DataLog

Simge	İsmi	İşlev
	Real-Time Chart	It shows datalog chart momentarily.
	History Chart	It shows old datalog's chart.
	History List	It shows old datalog as list.









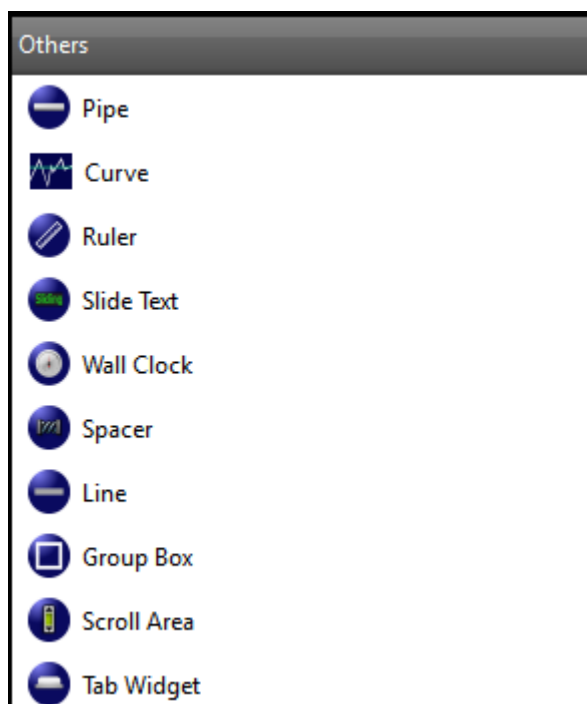

Table 2: DataLog

B.4.7. Others

Other elements can be used to display different functions on the screen.







Picture 42: Others

Icon	Name	Function
	Pipe	The motion in the pipe is displayed.
	Graph	The change of the value at the reading address is displayed graphically.
	Ruler	Used to its as units of measure of the value.
	Marquee	The text screen image is displayed by sliding.
	Clock	Displays the current time.
	Space	Leave a space between element tools.
	Line	Draws the line at the desired size on the form screen
	Group Box	It is provides a group box frame with a title.
	Scroll Area	It is provides a scrolling view onto another widget.
	Tab Window	It is provides a stack of tabbed widgets.

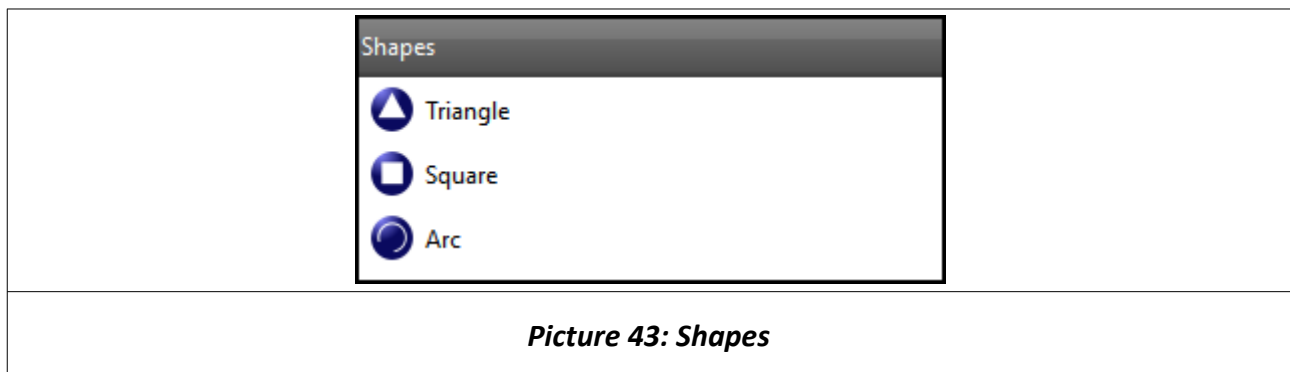
B.4.8. Shapes

The shape tools in the element list are used to triangle, square or draw.



Icon	Name	Function
  	Triangle, Square, Arc	Triangle, square or arc drawings can be made.

B.5. Properties List

B.5.1. Address

In the project, when the show data, buttons, data entry and gauges tools is used, address field actives.

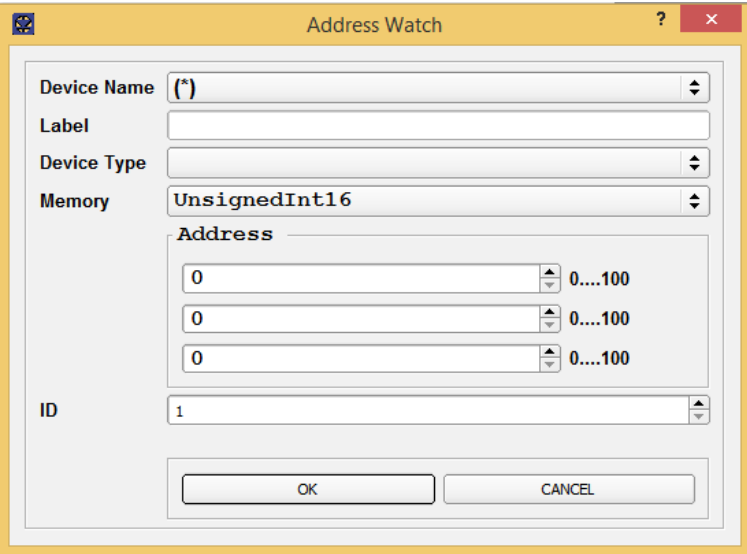
Name	Function			
<p>Read Address, Write Address , Hide Address</p>	<p>Enter slaveID, to define the read address. DeviceID is the field in which the ID of the device is written.Default value defines between 0-255.</p>			
	<p>Data type options are One of Bit, UnsignedInt16, SignedInt16, UnsignedInt32, SignedInt32, Float, UnsignedInt64, SignedInt64, Double.</p>			
	<table border="1"> <thead> <tr> <th data-bbox="421 797 635 831">Data Type</th> <th data-bbox="635 797 1034 831">Minimum</th> <th data-bbox="1034 797 1437 831">Maximum</th> </tr> </thead> </table>	Data Type	Minimum	Maximum
	Data Type	Minimum	Maximum	
	UnsignedInt16	-32,768	32,767	
	SignedInt16	0	65,535	
	UnsignedInt32	-2,147,483,648	2,147,483,647	
	SignedInt32	0	4,294,967,295	
	Float	1.8E-38	3.4E+38	
	UnsignedInt64	-9,223,372,036,854,775,807	9,223,372,036,854,775,807	
SignedInt64	0	18,446,744,073,709,551,615		
Double	2.2E-308	1.8E+308		
<p>...</p>	<p>Click the icon on the left to open the address watching form. Device Name, Device Type, Label, Memory and ID field are configured from address tracking window.</p> 			

B.5.1.1. Address Watch

The device address field settings are configured in the address watching form..

Address Watch Field	Function																								
Device Name	Internal_io includes internal input-output devices.																								
	Internal_memory, includes internal memory.																								
Device Type	If " internal_io " is selected in the device name field, there are 4 options for device type.																								
	<table border="1"> <thead> <tr> <th>Device Type</th> <th>Phrase</th> <th>Memory</th> <th>Range</th> </tr> </thead> <tbody> <tr> <td>Digital Input</td> <td>\$IX0.0</td> <td>\$Ixn.k</td> <td>n :0-0 k :0-4</td> </tr> <tr> <td>Digital Output</td> <td>\$QX0.0</td> <td>\$Qxn.k</td> <td>n :0-0 k :0-5</td> </tr> <tr> <td>Analog Input</td> <td>\$IW0</td> <td>\$IWn</td> <td>n :0-1</td> </tr> <tr> <td>Analog Output</td> <td>\$MW0</td> <td>\$MWn</td> <td>n :0-1</td> </tr> </tbody> </table>	Device Type	Phrase	Memory	Range	Digital Input	\$IX0.0	\$Ixn.k	n :0-0 k :0-4	Digital Output	\$QX0.0	\$Qxn.k	n :0-0 k :0-5	Analog Input	\$IW0	\$IWn	n :0-1	Analog Output	\$MW0	\$MWn	n :0-1				
	Device Type	Phrase	Memory	Range																					
	Digital Input	\$IX0.0	\$Ixn.k	n :0-0 k :0-4																					
	Digital Output	\$QX0.0	\$Qxn.k	n :0-0 k :0-5																					
	Analog Input	\$IW0	\$IWn	n :0-1																					
	Analog Output	\$MW0	\$MWn	n :0-1																					
	If " internal_memory " is selected in the device name field, there are 5 options for device type.																								
	<table border="1"> <thead> <tr> <th>Device Type</th> <th>Phrase</th> <th>Memory</th> <th>Range</th> </tr> </thead> <tbody> <tr> <td>Volatile Memory</td> <td>\$0</td> <td>\$n</td> <td>n : 0-65535</td> </tr> <tr> <td>Non-Volatile Memory</td> <td>\$M0</td> <td>\$Mn</td> <td>n : 0-65535</td> </tr> <tr> <td>Volatile Memory Bit</td> <td>\$0.0</td> <td>\$n.k</td> <td>n : 0-65535 k :0-15</td> </tr> <tr> <td>Non-Volatile Memory Bit</td> <td>\$M0.0</td> <td>\$Mn.k</td> <td>n : 0-65535 k :0-15</td> </tr> <tr> <td>Internal Settings</td> <td>\$S</td> <td>\$Sn</td> <td>n :0-65535</td> </tr> </tbody> </table>	Device Type	Phrase	Memory	Range	Volatile Memory	\$0	\$n	n : 0-65535	Non-Volatile Memory	\$M0	\$Mn	n : 0-65535	Volatile Memory Bit	\$0.0	\$n.k	n : 0-65535 k :0-15	Non-Volatile Memory Bit	\$M0.0	\$Mn.k	n : 0-65535 k :0-15	Internal Settings	\$S	\$Sn	n :0-65535
	Device Type	Phrase	Memory	Range																					
	Volatile Memory	\$0	\$n	n : 0-65535																					
	Non-Volatile Memory	\$M0	\$Mn	n : 0-65535																					
Volatile Memory Bit	\$0.0	\$n.k	n : 0-65535 k :0-15																						
Non-Volatile Memory Bit	\$M0.0	\$Mn.k	n : 0-65535 k :0-15																						
Internal Settings	\$S	\$Sn	n :0-65535																						
Memory	The memory field includes bit, unsignedInt16, signedInt16, unsignedInt32, signedInt32, float, unsignedInt64, signedInt64, and double.																								
	If " internal_io " is selected in the device name field, default value bit.																								
	If " internal_memory " is selected in the device name field, default value unsignedInt16.																								
ID	Identity device																								

Table 3: Address Property->Address Watch

B.5.2. Data

When the data show, data entry, gauges and other tools are used, the data section activates.

Name	Function						
Value	Read address value.						
cFormat	Writes the code to display the desired format value.						
fDigits	Defines for decimal numbers.						
Gain Offset	Sets value with mask.						
	Value=value * gain + offset $y=a.(x)+b$						
	<table border="1" data-bbox="422 739 742 851"> <thead> <tr> <th data-bbox="422 739 539 790">Value</th> <th data-bbox="539 739 639 790">Gain</th> <th data-bbox="639 739 742 790">Offset</th> </tr> </thead> <tbody> <tr> <td data-bbox="422 790 539 851">x</td> <td data-bbox="539 790 639 851">a</td> <td data-bbox="639 790 742 851">b</td> </tr> </tbody> </table>	Value	Gain	Offset	x	a	b
	Value	Gain	Offset				
x	a	b					
<p>Default gain value is '1.0'.</p> <p>For example; The gain value is '4.0'. When the LCD number element actual value is '10',the displayed value is '40'.</p> <p>Default the offset value is '0.0'.</p> <p>For example; The offset value is '1.0'. When the LCD number element actual value is '10',the displayed value is '11'.</p>							
Rounding	If this option is selected, value round.						
Minimum	Limits are determined of the read address value.						
Maximum							

Table 4: Data

B.5.3. Input

When the data input tools used, input section activates in the property list.

Name	Function
Single Step	Divides the interval between minimum value and maximum value into equal parts. The increase of the value is set.
Button Count	This field activates when the decrement/increment tools used.
Step Button 1-2-3	Defines the button name.
Value	This field activates when the slider 2 tool used. Default value is 50. Displays data value.
Page Step	Default value is 10.
Step Range	This field activates when the slider used. If the value in the step range field increases, the range size decreases and the step count decreases.
Inverted-Control	The Controllers reverses on the keyboard or mouse.
Tracking	If “tracking” is enabled, the data changes displays on the screen as the scroll button is moved.
Tick Position	<p>This field activates when the slider tool used. Options are notick, tickabove, tickleft, tickbelow, tickright, tickbothsides.</p> <div data-bbox="790 1243 1069 1433" data-label="Image"> </div> <p style="text-align: center;">Picture 44: Slider</p> <p>In Picture-36 above, the positioning field selected vertically and the positions of the steps selected as tickleft, tickright, and tickbothsides, respectively.</p> <div data-bbox="622 1646 1236 1724" data-label="Image"> </div> <p style="text-align: center;">Picture 45: Slider</p> <p>In Picture-37 above, the positioning field selected vertical positions of the steps selected as notick, tickbelow ve tickabove respectively.</p>

Table 5: Input Property

B.5.4. Value

When the gauges elements is used the value actives in the property list.

Name	Function
Minimum Value	Defines values of the limits.
Maximum Value	

Table 6: Value Property

B.5.5. General

The general section is active in all element tools in the property list.

Name	Function
Enabled	If element tool is enabled, element tool can use.
Location	Determines the country where the devices are located 
Current State	Defines the state data of the selected element tool This data can be picture, code written in the style macro window, text, or any value.
nState	Defines The total number of states of the selected element tool
Reverse State	Changes the current state of the value in the defined address changes.
Position	Defines horizontal or vertical of the element tool.

Table 7: Value Property

B.5.6. Button

When the buttons and Svg buttons is used, the button sections activates in the property list.

Name	Function
<p>Buton Type</p>	<p>Button types are Push, Checkable, Set, Reset, Value Assignment, Fixed Assignment, Multiple Status, Increase, Decrease and HMI Settings.</p> 
<p>Page Function</p>	<p>The selected button gives the pagination function. Page functions are Non, Go to Previous, Go to Next, Go to Home, Go to Index.</p> 
<p>State Type</p>	<p>Durum types are Next, Previous State.</p> 
<p>Auto Repeat Invertal</p>	<p>Default value is 100 ms. It is used to set the interval time between two movements.</p>
<p>Auto Repeat Delay</p>	<p>Default value is 300 ms. It is used to set delay time for waiting the startup of PLC or external.</p>
<p>Auto Repeat</p>	<p>If “auto repeat” is enabled, auto repeat repeats the function using in the interval field value as a period.</p>
<p>Checkable</p>	<p>When the button is pressed, button displays checkabled.</p>
<p>Index Page</p>	<p>When the button is clicked, page number is written on which go to page is want to.</p>

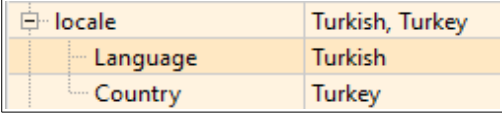
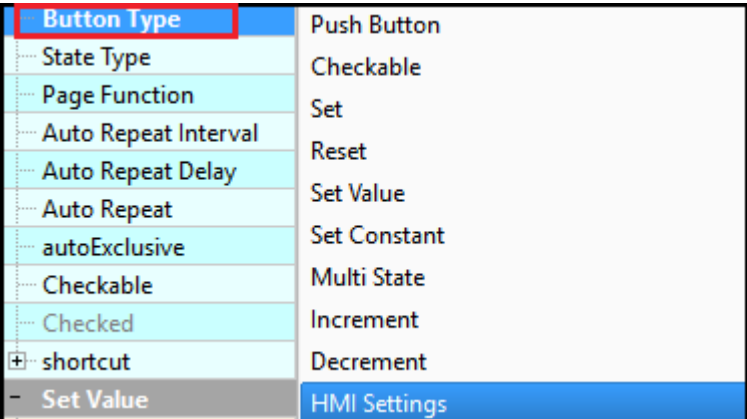
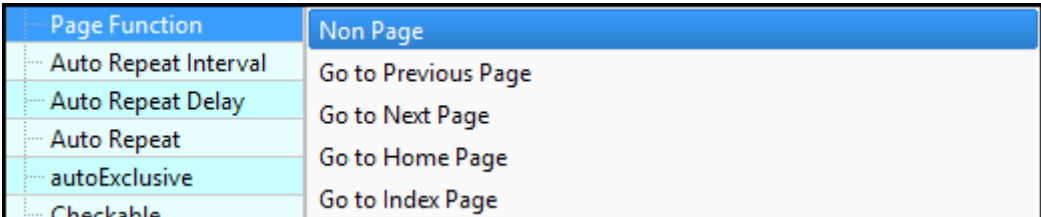
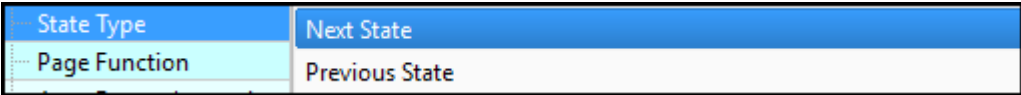
B.5.7. Special

When data entry, gauges and other element tools is used, the special section actives in the property list.

Name	Function	Used Elements
Display Type	Display options are LbNormal, LbMarquee.	Plain Text
	<i>“LbNormal”</i> displays text value.	
	<i>“LbMarquee”</i> displays text value how is marquee.	
Direction	If element tool is enabled, marquee element can uses.	Plain Text
	<i>“RightToLeft”</i> , the text skips from right to left.	
	<i>“LeftToRight”</i> , the text skips from left to right.	
Speed	Determines the text speed of the marquee element.	Plain Text, Pipe
	The water(fluid) object speed determines in pipe, if element tool is used.	
Pixmap	 Click the icon on the left to open the resources form and selects image or font type.	Show Picture
Scaled Contents	To resize the image.	Show Picture, Multi State, Range State, Motion Animation, State Animation
Range	Determines range count.	Range State
Date Format	Defines date and time at the desired format. The format example can enter as follows. 	Date Time
Interval	Default value is 1000ms. Updates the element tool.	Date Time
Movie Active	When element tool is enabled, the element tool used to show simple animation without sound.	Motion Animation
Percent Speed	Defines the speed value of the picture.	Motion Animation

Table 8: Special Property -1

Name	Function	Used Element
Segment Style	Segment style filled, framed and flat options are as follows. <div style="text-align: center;">  <p><i>Picture 46: Lcd Number</i></p> </div>	Lcd Number
Mode	Segment mode options are decimal, bin, hex, oct.	Lcd Number
SmallDecimalPoint	If the field is selected, the segment size decreases in a certain rate.	Lcd Number
Digit Count	Defines the number of digits of the data value.	Lcd Number, Circular Bar
IntValue	It is value at on the screen	Spin Box
Decimals	Defines the number of digits of the decimal part of the data.	Spin Box Counter
Keyboard Tracking	If the “keyboard tracking” are selected, the data change displays when button is clicked.	Spin Box
	If the “keyboard tracking” isn't selected, the data change wont be displayed while the button is clicked. Displays the value at the end of the motion.	
Prefix, Suffix	Adds the text of the displayed data at front or end.	Spin Box, Thermometer 2, Manometer
correctionMode	If an invalid value is entered in the data field, the data to be assigned to that value is specified as one of the options. The correction options are nearest and previous value.	Spin Box
accelerated	The process varies with acceleration.	Spin Box
correctionMode	If an invalid value is entered in the data field, Defines the mode to correct an Intermediate value. The correction options are nearest and previous value.	Spin Box
specialValueText	It can use as text display.	Spin Box

Table 9: Special Property -2

Name	Function	Used Elements
buttonSymbols	Button style options are UpdownArrow, PlusMinus, NoButtons as follow.  <i>Picture 47: Değer Arttır/Azalt-2</i>	Spin Box
Read Only	If it is enabled, no action(edit) can not be taken on the element tool.	Spin Box, Spin Box 2
Wrapping	If the field is selected return value.	Spin Box, Spin Box 2
Frame	Adds the frame at the element tool.	Spin Box
Enable Numeric Indicator	The field that displays the data change on the screen and writes the data value to the screen.	Analogmeter, Circular Bar
	If the digital meter is not selected, the data change hide. The point is added in place of the indicator. It shows is Picture-40.	
	If the enable " <i>numeric indicator</i> " is not selected in the circular bar, the data value hides.	
Start Angle End Angle	When the start and end angle of the arc is specified, the arc display arranges.	Tachometer, Analogmeter, Sirküler Bar, Termometre, Amperemeter,
Step	The value range between minimum and maximum is divided by the value in the step field. Creates steps.	Analogmeter Sirculer Bar
Steps 2	Divides between two steps equal to the value in the intermediate step field. Creates steps 2.	Analogmeter

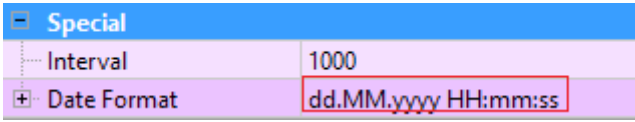
Table 10: Special Property -3



Name	Function	Used Elements
Units	When the gauge element tool is used, this field activates. Determines the unit of the element tool value.	Analogmeter
Enable Crown	When the gauge element tool is used, this field activates. If the gauge is selected, displayed as Picture-40. If the gauge isn't selected, displayed as Picture-41.  <i>Picture 48: Analogmeter2 Picture 49: Analogmeter</i>	
enableAreas	If the “enable areas” is enabled, can colors the step ranges. If the area is enabled as displays Picture-40. If the area isn't enabled as displays Picture-41.	Analogmeter
area1-2-3-4-5 begin	Defines the initial values of the step ranges	Analogmeter
area1-2-3-4-5 end	Defines the end values of the step ranges	Analogmeter
area1-2-3-4-5 color	Defines the color of the step ranges	Analogmeter
Circular Bar Enabled	It is the tool in Picture-42 that displays the data exchange.  <i>Picture 50: Sirküler Bar</i>	Circular Bar

Table 11: Special Property -4

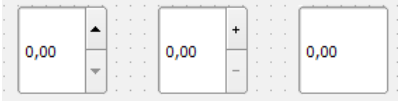
Name	Function	Used Elements
Threshold	Defines the beginning of the threshold value. The image of the down limit arc as in Picture-42 above is red.	Analogmeter, Circular Bar, Tank
Bar Size	Defines size of the circular bar.	Circular Bar
Cover Glass Enabled	When circular bar is used, this field activates. It shines on circular bar.	Circular Bar
Enable Threshold	If the <i>“enabled threshold”</i> is enabled, it displays on the screen. If the <i>“enabled threshold”</i> isn't enabled, it hides.	Circular Bar
NumTicks	If the tank element tool is used, this field activates. Divides the value between the minimum and maximum values as shown in Picture-43.  <i>Picture 51: Tank</i>	Tank
showCurrentDate/Time	If the wall clock is used, this field activates. If this field is selected, the current date/time displays on the screen.	Wall Clock
Date/Time	If the wall clock is used, this field activates. If showCurrentDate/Time isn't selected, the desired date / time value sets.	Wall Clock
Day Font, Date Font, Time Font, Digit Font	Sets the font of the object.	Thermometer, Manometer, Wall Clock

Table 12: Special Property -5

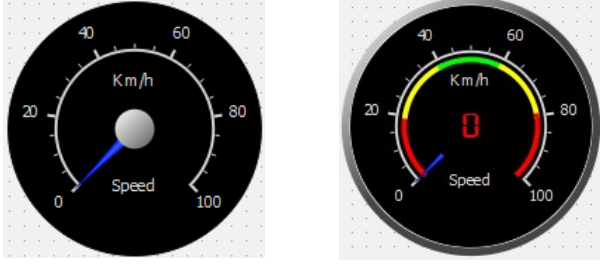
Name	Function	Used Elements
DigitColor, DateColor, DayColor, TimeColor	Sets the color of the object. The wall clock tool shows in Picture-44 below. <div style="text-align: center;">  <p><i>Picture 52: Duvar Saati</i></p> </div>	Wall Clock
digitOffset, dateOffset, dayOffset, timeOffset	Sets the distance from the center of the object.	Thermometer, Manometer, Wall Clock

Table 13: Special Property -6

B.5.8. Visual

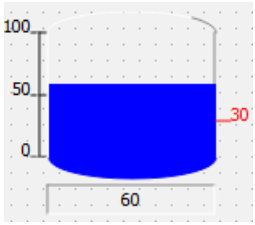
Visual properties are used in all element tools.

Name	Function
Visible	<p>If the button tool is used, this field activates.</p> <p>If the “<i>visible</i>” field is selected, it displays or hides of the element tool.</p>
Style Sheet	<p> When the icon is clicked on the left, style edit form open.</p> <p>For the element tool view, user can add source image, gradient, add font option. Style code can add to the area where cursor is located.</p> <div data-bbox="549 719 1310 1240" style="border: 1px solid #ccc; padding: 10px; margin: 10px auto; width: fit-content;">  </div> <p style="text-align: center;"><i>Picture 53: Style Sheet->Edit Style Sheet</i></p>
Frame Style	<p>If the potentiometer tool is used, this field activates.</p> <div data-bbox="571 1384 1289 1559" style="text-align: center;">  </div> <p style="text-align: center;"><i>Picture 54: Potantiometer Options</i></p>

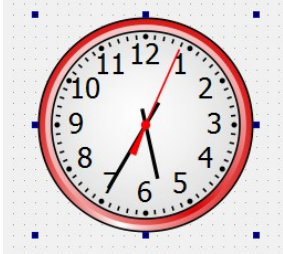
Table 14: Visual Property -1



Name	Function	
Text	Displays the desired text.	
Label	Element tool is name.	
LabelPosition	The label position are the left, right, top, bottom or center.	
Background Color	<p>If the “flat” is enabled in the general section, background color sets of the button tool.</p>  <p style="text-align: center;"><i>Picture 55: Background Color->Select Color</i></p>	
Foreground Color	<p>When the analogmeter is used, this field activates.</p> <p>Foreground color sets of the analogmeter tool.</p>	
Font Style	<p>When “intermittent” is selected, text displays with fixed range.</p> <p>When “sliding” is selected, marquee displays.</p>	
Font Type	Selects the font types.	
Font Color	Selects the font color.	
pixlbPicture		<p>If the button tool is used, this field activates.</p> <p>When the icon is clicked on the left, style edit form opens.</p>
Picture Alignment	The picture alignment options are horizontally and vertically.	

Table 15: Visual Property -2

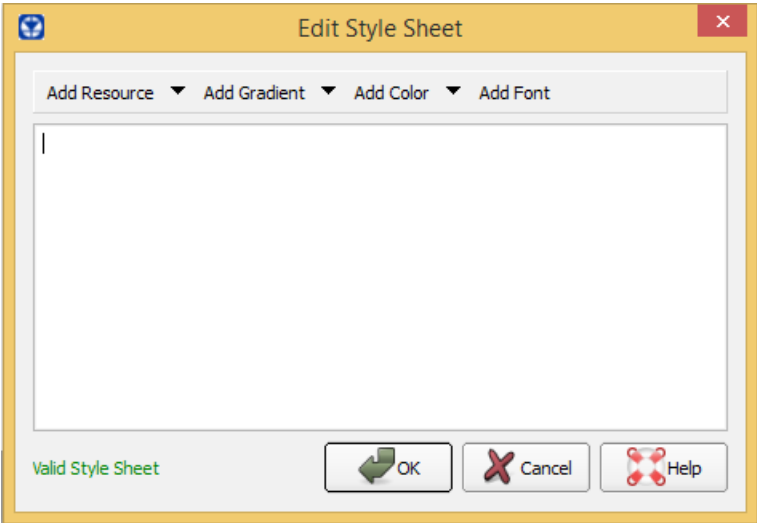
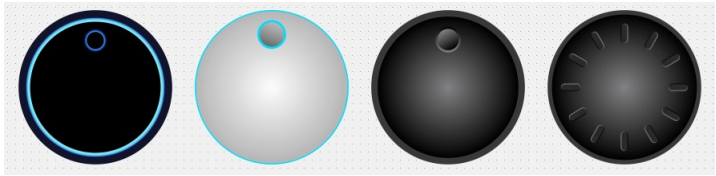

Name	Function	
Flat	To upload the desired image, the “flat” field must enabled.	
Icon Size	Defines the width and height values of the icon.	
Icon		When the icon is clicked on the left, style edit form opens.
Word Wrap	If this field is enabled, the text is wrapped where necessary at word-breaks.	
Focus	Focus type options are Nofocus, Tabfocus, Clickfocus, Stringfocus, Wheelfocus.	
Font Format	Font format options are Richtext, Plaintext, Logtext, Ototext.	
Text Direction	If the multi slider tool is used, this field actives. Text direction options are TopToBottom, BottomToTop.	
Orientation	Selects the leftright or bottomtotop the slider button direction. <div style="display: flex; justify-content: space-around; align-items: center;"> <div style="text-align: center;">  <p>Picture 56: Slider</p> </div> <div style="text-align: center;">  <p>Picture 57: Slider</p> </div> </div>	
Text Visible	If the multi slider or progress bar tools are used, this field actives. The value displays on the screen as text format.	
Aligment	Alignment options are vertical alignment and horizontal alignment.	
	Text is alignment at the left, right or center on vertically.	
	Text is alignment at the top, bottom or horizontal on horizontally.	
Title	If analogmeter 2 and group box is used, this field actives. Text is displays on the screen.	
Margin	The width of the margin.	
Indent	Text indent in pixels.	
KaydırmaYönü	Scroll button direction options are TopToBottom, BottomToTop.	
Tank Rengi		If the tank tool is used, this field actives. When the icon is clicked on the left, fluid color selects at the tank tool.

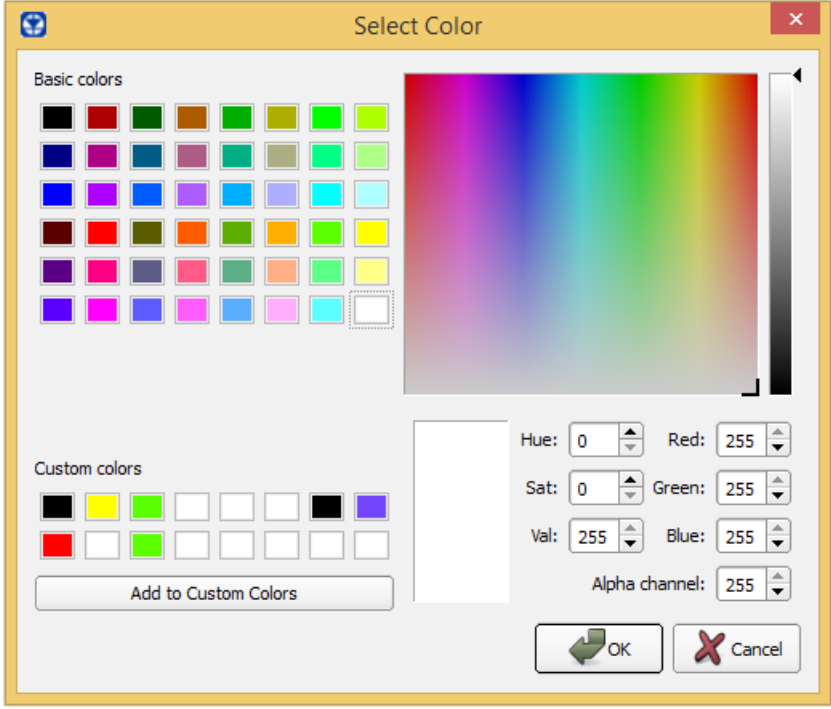
Table 16: Visual Property -3

B.5.9. Geometry

When the gauges and other element tools are used, this section activates.

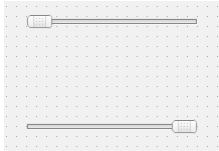
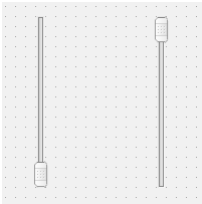
Name	Function
Geometry	The coordinates of the selected element are determined according to the position on the page.
Size Policy, Base Size, Size Increment, Minimum Size, Maximum Size	Determines the minimum and maximum size of the selected element tool.

Table 17: Geometry Property

B.5.10. Set Value

When the button element is used, this section activates in the property list.

Name	Function
Step Value Minimum Maximum	Minimum and maximum value is determined of the percent value.
Constant Value	Constant value is set at the element tool.

Table 18: Set Value Property

B.5.11. Macro

When the button element is used, this section activates in the property list

Name	Function
Before Pressed Release	When the before, pressed or release is clicked, opens <i>'edit makro form'</i> .

Table 19: Macro Property

B.5.12. Frame

When the data entry, shapes and other tools are used, the frame section activates.

Name	Function
<p>Frame Shape</p>	<p>The options are NoFrame, Box, Panel, WinPanel, Hline, Vline, StyledPanel.</p> <p>The frame shapes show in the following order.</p>  <p style="text-align: center;"><i>Picture 58: Frame Shape</i></p>
<p>Frame Shadow</p>	<p>Options are Plain, Raised, Sunken.</p> <p>The frame shadows show in the following order.</p>  <p style="text-align: center;"><i>Picture 59: Frame Shape</i></p>
<p>Line Width</p>	<p>Determines the bold of the frame.</p>
<p>Mid Line Width</p>	<p>The field that draws a line horizontally on the element tool and determines the line width.</p>

Table 20: Frame Property

B.5.13. Shape

When the shape tools are used, the shape section activates in the property list.

Name	Function
Line Color Ground Color	The user determines of the desired color or background color for the shape tool.
Line Width	The user determines of the line width for the shape tool.
Shape	<p>There are options square, arc and triangle of the shape element tool. If arc is drawn, start angle and end angle must determine.</p> <div data-bbox="705 719 1192 846" data-label="Image"> </div> <p style="text-align: center;"><i>Picture 60: Shapes</i></p>
Start Angle	If the arc is used, this field activates.
End Angle	An arc can draw determining the start and end angles.

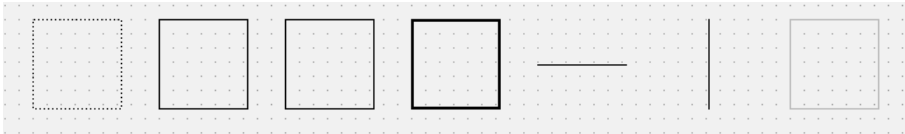
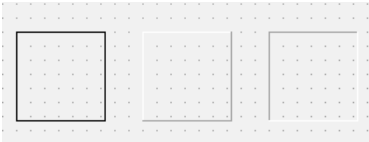
Table 21: Frame Property

B.5.14. Line

Only ruler element tool uses this section.

Name	Function
<p>Rotation</p>	<p>The rotation options are horizontal, vertical, rotation_180 and rotation_270.</p> <div data-bbox="810 568 1083 934" data-label="Image"> </div> <p style="text-align: center;"><i>Picture 61: Ruler</i></p> <p>The above picture, the rotation of the ruler set to standard and rotation_270 according to the order of the picture.</p> <div data-bbox="557 1146 1339 1301" data-label="Image"> </div> <p style="text-align: center;"><i>Picture 62: Ruler</i></p> <p>The above picture, the rotation of the ruler set to rotation_90 and rotation_180 according to the order of the picture.</p>

Table 22: Line Property

B.5.15. Pipe

When the pipe tools are used, the pipe section activates in the property list.



Name	Function
Background Color	 When the icon is clicked on the left, the water(fluid) color determine in the pipe tool.
Rotation	The user select the element tool direction. The options are standard(horizontally) and rotation_90(vertically).
State	This option determines the state of the water(fluid).
	If the “ disable ” is selected, the water(fluid) does not move in the pipe.
	If the “ enable ” is selected, the water(fluid) moves in the pipe.
vDirection	The direction of the water(fluid) can selects from left to right or from right to left. The rotation is horizontal.  <i>Picture 63: Pipe</i>
	The direction of the water(fluid) can selects from top to bottom or from bottom to top. The rotation is vertical.  <i>Picture 64: Pipe</i>

Table 23: Line Property

B.5.16. Scale

When the tachometer tools are used, the scale section activates in the property list.

Name	Function
Needle Origin x	If the tachometer is used, this field activates.
Needle Origin y	The position define of the needle on the element tool.

Table 24: Scale Property

B.5.17. Chart

When the chart element tool is used, the chart section actives in the property list.

Name	Function	
Top Background Color, Bottom Background Color, GridColor		The user can make custom color selection on the appeared color picker dialog.
Period	Default values is 1000ms. Graph channels sampling interval time.	
Position	Scrolls the active visible area.	
Size	Default value is 10000. If the size value increases, it will read more than the X-axis value.	
Zoom	If the zoom value increases, the graphic will display in detail.	
Xmesh,	This field is half of the number of grids on the horizontal.	
yMesh	This field is half of the number of grids on the vertical.	
xSubMesh	The ' xSubMesh ' divides between both grids on the horizontal.	
ySubMesh	The ' ySubMesh ' divides between both grids on the vertical.	
showGrid	If " showGrid " is enabled, the vertical and horizontal grids will display. If " showGrid " is not enabled, the vertical and horizontal grids will hide.	
showScale	If the display is selected, the data values will display at the horizontal.	
showLegend	If the display is selected, the text title will display of the values. To define the ' text title ', right click on the cursor while the cursor is over the chart element tool. More then click the ' edit items ' title from open window.	
Antialiasing	Enables the 'antialiasing' feature.	

Table 25: Chart Property



Picture 65: Chart

To edit the chart element tool;

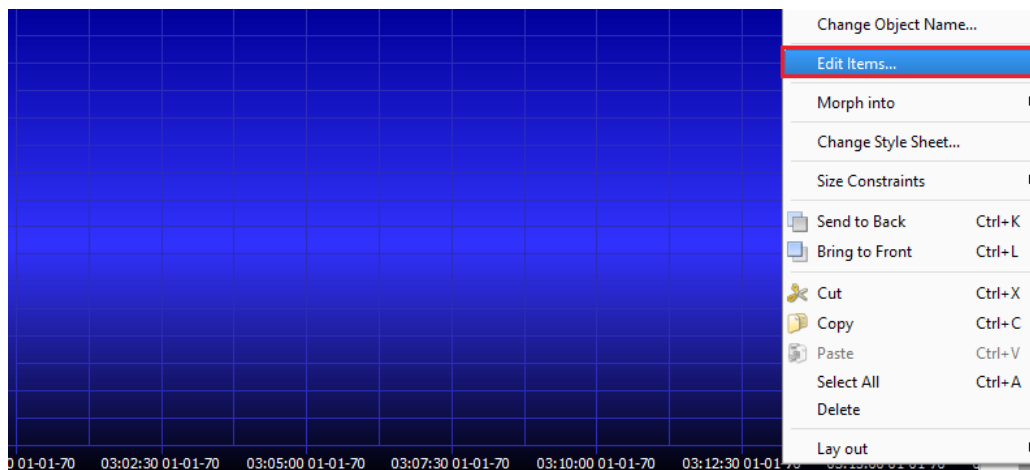
- Right click on the cursor, while the cursor is over the chart element tool.
- Click the '**edit items**' title from opened window.
- A new form will open as below.

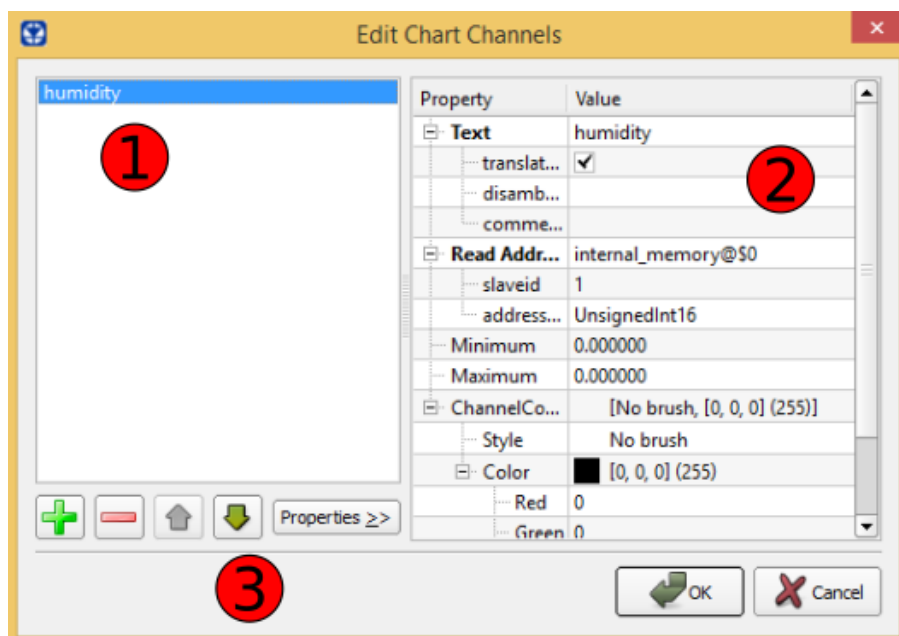

Picture 66: Chart->Edit Chart Channels

- This window edits curves(channels) in the chart.
- On number field 1, curves list and Curve name selects the desired.
- On number field 2, properties edit of the selected chart.
- On number field 3, create a new curve, delete the selected curve, move the curve up or down the list.

B.6. Element Tree

Lists the used element tools as tree on the form screen.

Object	Class
Sayfa_10	EForm
groupBox	QGroupBox
elabel_2	QLabel
qelabel_10	QLabel
qelabel_8	QLabel
qelabel_9	QLabel
qtSvgSlideSwitch	QtSvgSlideSwitch
groupBox_2	QGroupBox
epushButton	QEPushButton
epushButton_2	QEPushButton
epushButton_3	QEPushButton
epushButton_4	QEPushButton
epushButton_5	QEPushButton
epushButton_6	QEPushButton
epushButton_7	QEPushButton
epushButton_8	QEPushButton
groupBox_3	QGroupBox
SVGScrollDial	QtScrollDial
elabel	QLabel
qelabel_11	QLabel
qeslider	QESlider
groupBox_33	QGroupBox

Picture 67: Element Tree

C) Macro

For more information, you can examine Macro Wizard window.

C.1. Variable Types

Operator	global
Comment	Defines a global variable to use in all of macro code.
Example	<pre>global var1; //A global variable named var1 was created. var1 = 5; //Variable 5 is assigned to variable var1</pre>

Operator	local
Comment	Defines a variable to use in the function it contains.
Example	<pre>local var1; // A local variable named var1 was created. var1 = 10; //Variable 10 is assigned to variable var1.</pre>

Operator	\$n
Comment	Volatile variable specifies at assigned in the internal memory
Example	<pre>\$10 //The volatile variable number 10 is //specifies to address</pre>

Operator	\$Mn
Comment	Non-volatile specifies at addressing in the internal memory.
Example	<code>\$M10 //The non-volatile variable number 10 is //specifies to address</code>
Operator	{device name}device id@n
Comment	Specifies the variable assignment at the desired address of the connected device.
Example	<code>AMF}1@10 //This usage specifies the address 10 of the // device named Amf with device ID 1.</code>

C.2. Arithmetic Operators

Operator	+
Comment	Used to the sum of two values.
Example	<code>var1 = 10 + 20; //Adds 10 to 20 and assigns the result to //variable var1.</code>

Operator	-
Comment	Used to the subtract of the two values.
Example	<code>var1 = 20 - 10; //Subtracts the value of 10 from 20 and //assign the result to variable var1</code>

Operator	*
Comment	Used to multiplication of the two values.
Example	<code>var1 = 10 * 20; //Multiplies the value 10 by 20 and assign //the result to variable var1</code>

Operator	/
Comment	Used to division of the two values.
Example	<code>var1 = 20 / 10; //Divides 20 by 10 and assign the result to //variable var1</code>

Operator	=
Comment	Used to assign value at variable or assign value of the other value at variable.
Example	<code>var1 = var2 //Assign the value of var2 to var1</code>

Operator	<code>sqrt(n)</code>
Comment	Used to find square root of the value.
Example	<code>var1 = sqrt(9); //The square root of the value 9 is assigned //to var1.</code>

C.3. Boolean Operators

Boolean operators are used with the if and while operators and return the comparison results as true or false.

Operator	<
Comment	Returns true if the value to the left of the operator is less than right, false otherwise.
Example	<code>if var1 < 10 //if the value var1 is less than 10</code>

Operator	>
Comment	Returns true if the value to the left of the operator is greater than right, false otherwise.
Example	<code>if var1 > 10 //var1 değeri 10'dan büyükse //if the value var1 is greater than 10</code>

Operator	<=
Comment	Returns true if the value to left of the operator is less than or equal to right, false otherwise. Operatörün solundaki değer sağındakinden küçükse veya eşitse doğru (true), değilse yanlış (false) döner.
Example	<code>if var1 <= var2 //if the value var1 is less than or equal to //var2</code>

Operator	>=
Comment	Returns true if the value to left of the operator is greater than or equal to the right, false otherwise.
Example	if var1 >= var2 //if the value var1 is greater than or equal //to var2

Operator	==
Comment	Returns true if the value to left of the operator is equal to right, false otherwise.
Example	if var1 == var2 //if the value var1 is equal to var2

Operator	!=
Comment	Returns true if the value to left of the operator isn't equal to right, false otherwise.
Example	if var1 != var2 //if the value var1 isn't equal to var2

Operator	
Comment	Returns true if the condition on the left of the operator or the condition on the right is true, false otherwise.
Example	if var1 < 5 var2 > 5 //if the value var1 is less than 5 or //greater than 5

Operator	&&
Comment	Returns true if the condition on the left of the operator and the condition on the right is true, false otherwise.
Example	if var1 == 0 && var2 != 2 //if the value var1 is equal to 0 and //if the value var1 isn't equal to 2

C.4. Logical Operators

The conditional operator “if” compares using the boolean operators and executes the desired code columns.

```
if expression1
```

```
    statement1
```

```
else
```

```
    statement2
```

```
endif;
```

If expression1 is true, statement1 will be executed.

If expression2 is false, it will run expression2.

End if should be placed end of.

Örnek:

```

if var1 == 0                //if var1 is equal to 0

    var2 = 10;                //var2 is equal to 10

else                        //if var1 not equal to 0

    var2 = 20;                //var2 is equal to 20

endif;                      //end

```

The conditional loop operator “**while**” compares using the boolean operators and executes the code column in a loop according to the specified condition.

```

while expression

```

```

...

```

```

endw;

```

While loop executes the code into the loop as long as expression1 is true.

endw should be placed end of.

Example:

```

while var1 != 100           //as long as the value of var1 is not 100

    var2 = var2 + 1;         //increase var2 by 1

    var1 = var2;             //equal var2 to var1

endw;                       //end

```

The loop operator “**for**” executes the code column in a loop as the specified number of times.

```
for variable1 = value1 to value2 do
```

```
...
```

```
endfor;
```

When the for loop is used with **to**, the value of variable 1 is initialized equal to value1.

Increase by 1 in each loop.

The for loop is executed in a loop until it reaches value2.

endfor should be placed end of.

```
for variable1 = value1 downto value2 do
```

```
...
```

```
Endfor;
```

When the **for** loop is used with **downto**, the value of variable1 is started equal to value1.

Decrease by 1 in each loop.

The for loop is executed in a loop until it reaches value2.

endfor should be placed end of.

Example:

```

for var1 = 0 to 100 do                                //var1 loop from 0 to 100
var2 = var2 + 1;                                        //increase var2 by 1 at the each loop
endfor;                                                //end
for var1 = 50 downto 0 do                            //var1 loop from 50 to 0
var2 = var2 - 1;                                        //decrease var2 by 1 at the each loop
endfor;                                                //end

```

C.5. Others

Operator	func - endf
Comment	Used to definition a function.
Example	<pre> func function1() //define function1 ... endf //end </pre>
Operator	call
Comment	Used to call/execute a function.
Example	<pre> call function1(); //execute/call function1 </pre>

Operator	sleep
Comment	Used to wait for a period of time in milliseconds.
Example	<code>sleep(1000); //wait 1000 millisecond</code>
Operator	endp
Comment	Comes at the end of the macro code and specifies that the macro code ends here.

Operator	getsystick
Comment	Represents an increasing value in internal memory as milliseconds.
Example	<pre>if(getsystick() - \$10 > 5000) //Increase a variable by 1 //for 5000 ms a = a + 1; \$10 = getsystick(); endif;</pre>

Operator	getstime
Comment	Retrieves system timing information.
Example	<pre>\$0 = getstime(); //system time is assigned //to \$0.</pre>

Operator	getsystouch
Comment	is used to get elapsed time since last interaction with screen.
Example	<code>\$0 = getsystouch(); //get elapsed time since last //touch</code>

Operator	writeonce
Comment	is used to shift address and write value.
Example	<code>for i = 0 to 2 do //addresses are shifted writeonce(\$10, i) = getonce(\$20,i); //as much as i's value endfor; //then read and written</code>

Operator	getonce
Comment	is used to shift address and read value.
Example	<code>for i = 0 to 2 do //addresses are shifted writeonce(\$10, i) = getonce(\$20,i); //as much as i's value endfor; //then read and written</code>

Operator	writesync
Comment	is used to write value synchronously.
Example	<code>varMod1 = //if writesync can write writesync("modbus1@40001", 1); //value it returns 1 if //not -1</code>

Operator	putbuf - writebuf
Comment	putbuf puts values to buffer and writebuf sends.
Example	<pre>varBuf = mw_putbuf("modbus1@40001",\$1); //if writebuf can varBuf = mw_putbuf("modbus1@40002",\$2); //send buffer varMod1 = mw_writebuf(); //successfully //returns 1 if not -1</pre>

Operator	putbuf - writebufsync
Comment	putbuf puts values to buffer and writebufsync writes.
Example	<pre>varBuf = mw_putbuf("modbus1@40001",\$1); //if writebuf can varBuf = mw_putbuf("modbus1@40002",\$2); //write buffer varMod1 = mw_writebuf(); //successfully //returns 1 if not -1</pre>

Operator	loadrecipe
Comment	is used to call prepared recipes.
Example	<pre>loadrecipe("Dough","Bread"); //This operation has // "Dough" named recipe //and "bread" named //recipe data</pre>

Operator	resetcomm
Comment	is used to reset communication.
Example	<pre>resetcomm("modbus","1"); //reset modbus device</pre>

C.6. Type Conversion

This is a feature that helps to convert various data types between each others. It is used with codes in macro page.

Conversions are like:

(int) : integer conversion.

(double) : double conversion.

(float) : float conversion.

In this example, value of \$1 address is converted to double value and written to 40001 address of modbus1 device.

```
func main()
```

```
modbus1@40001 = (double) $1;
```

```
endf
```

```
endp
```

C.7. Macro Wizard

Macro Wizard is a help window which lists all macro commands and it has explanations and examples too. Thanks to this window, macro commands can be prepared in accordance with its format and added to macro code window.

Macro Wizard can be reached with  this button on macro window.

First drop down list includes group names of commands and the second includes commands. Command can be selected with “Select” button and its explanation and example can be reached with “?” button. After selection a command, if it has variables, they are listed and for variable selection, cells being under “Variable Selection” column should be clicked and edited. When all variables are edited, “OK” button is clicked. Prepared command is added to cursor’s position on macro code window.

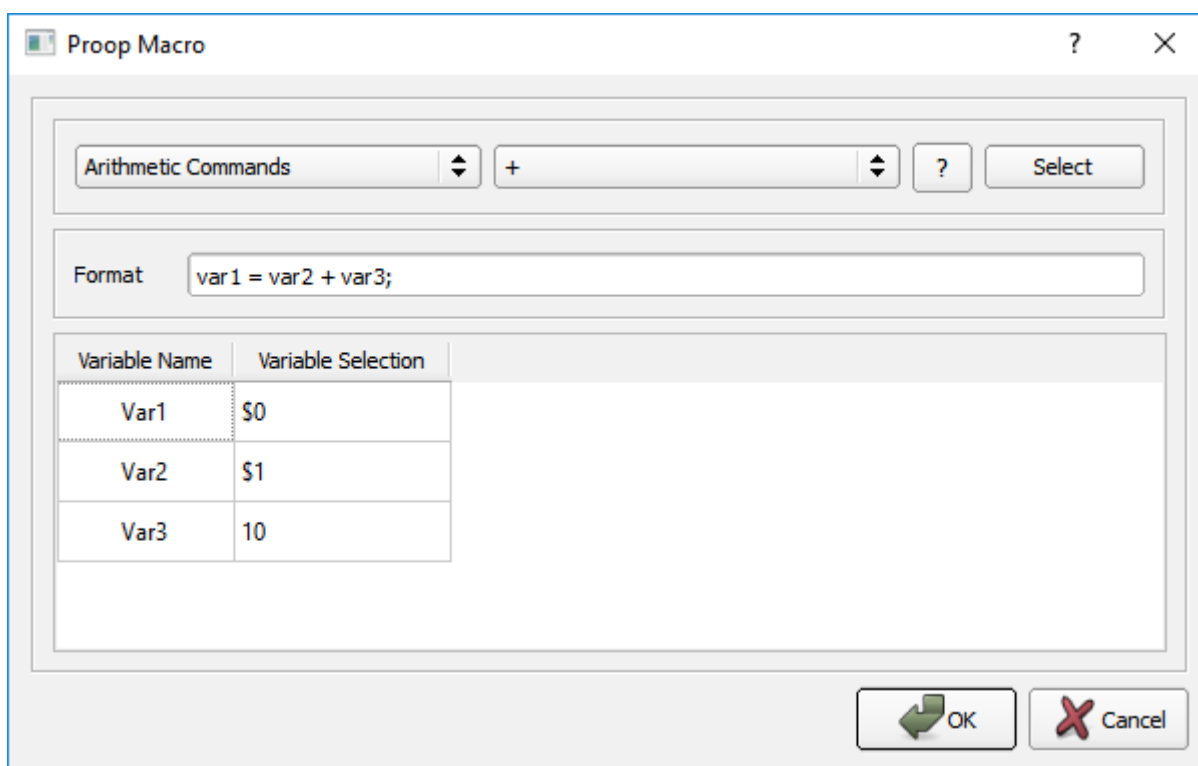

Picture 68: Macro Wizard

D) PROOP Connections

D.1. Models

Models	PROOP	COM2	COM3	COM4	ETH	Digital	Analog	USB	USB
	Types	RS-485	RS-232	RS-232		Input/Output	Input/Output	Host	Server
7" Model Types	7L	✓	✓	✓				✓	✓
	7L.E	✓	✓	✓	✓			✓	✓
	7C	✓	✓	✓		✓		✓	✓
	7C.E	✓	✓	✓	✓	✓		✓	✓
10" Model Types	10L	✓	✓	✓				✓	✓
	10L.E	✓	✓	✓	✓			✓	✓
	10C	✓	✓	✓		✓		✓	✓
	10C.E	✓	✓	✓	✓	✓		✓	✓
	10P	✓	✓	✓		✓	✓	✓	✓
	10P.E	✓	✓	✓	✓	✓	✓	✓	✓

Tablo 26: PROOP Model List

D.2. View Panel

The front face of the PRO Operator Panel is as in Picture-61 below and the leds on. Leds are numbered and explained in Table-27.



Picture 69: PROOP-Front View

1	COM	Communication led with PLC
2	CPU	Displays the current state of the CPU.
3	PWR	An energy led.

Tablo 27: PROOP-Front View

The back side of PROOP is different in the models.

The back view of the panels has been examined in two different ways as PROOP 7" Models and PROOP 10" Models.

The back of the PROOP 7 " models is as shown in Picture-61 below.

Inputs are numbered and inputs numbered in Table-28 are explained.

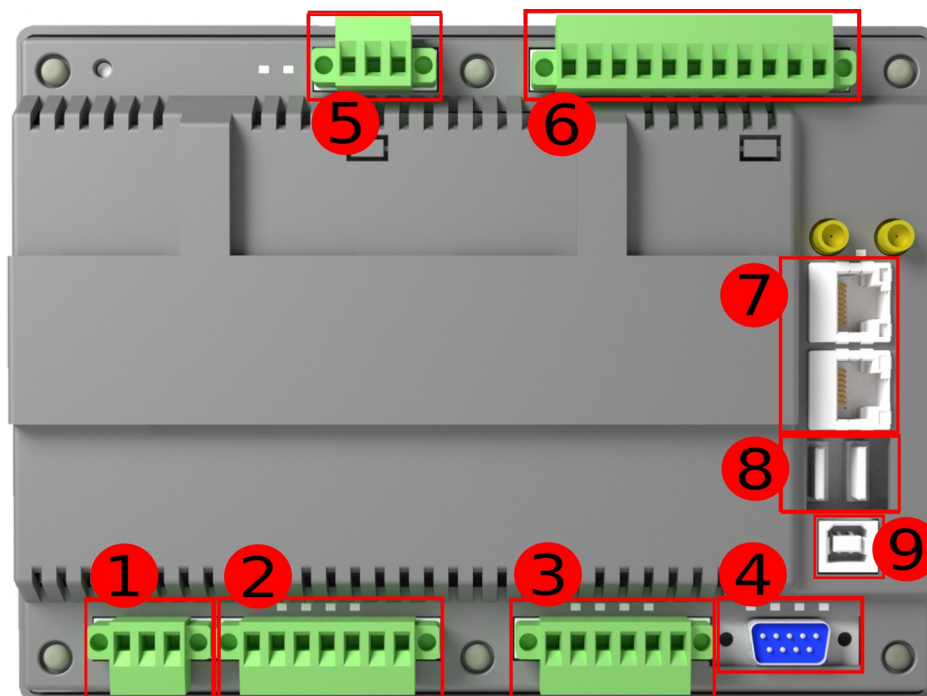

Picture 70: PROOP 7" Back

1	Energy	6	Digital Inout/Output
2	COM1	7	Ethernet
3	COM2-COM3	8	USB Device
4	COM4	9	USB Host
5	Not use		

Table 28: PROOP 7" Inputs

The back of the PROOP 10" models is as shown in Picture-62 below.

Inputs are numbered and inputs numbered in Table-29 are explained.

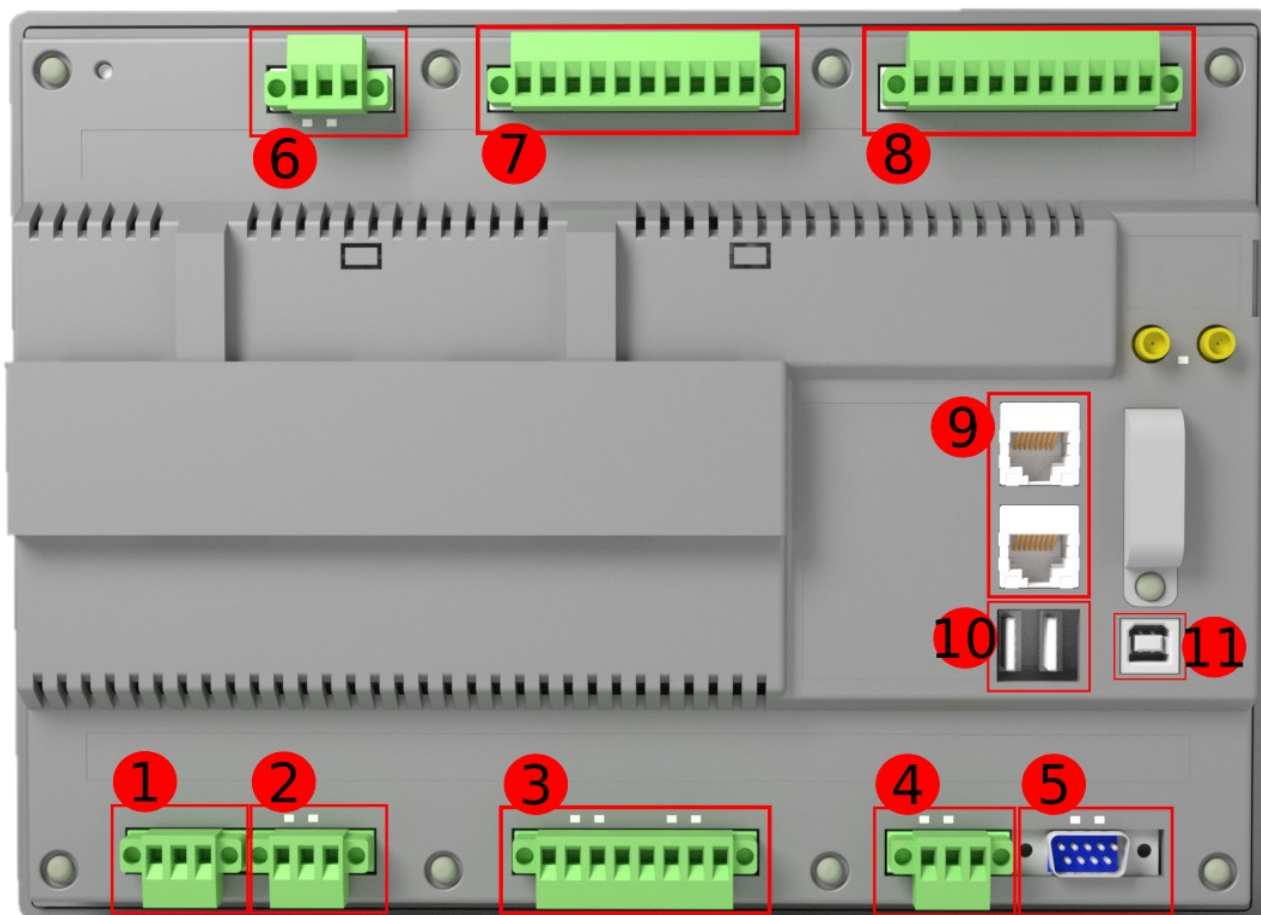

Picture 71: PROOP 10" Back

1	Energy	7	Analog Input
2	Out of use	8	Analog Output
3	COM1-COM2	9	Ethernet
4	COM3	10	USB Device
5	COM4	11	USB Host
6	Out of use		

Table 29: PROOP 10" Inputs

D.2.1. Pin Connections

PROOP 7" Model and PROOP 10" Model, the terminals used on the back are different and the pin connections are different.

The different terminals pin connections with PROOP 7" and PROOP 10" terminals are described under separate headings.

D.2.1.1. Supply



	Inputs
	+
	-
	

Table 30: Supply Connections

D.2.1.2. COM4

	Inputs
	2--Rx
	3--Tx
	5--GND
	7--RTS
	8--CTS

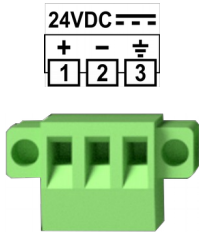
Table 31: COM4 Pin Connections

D.2.2. Pin Connections in PROOP 7" Models

D.2.2.1. COM1

	COM1: RS-422 Rx+ Rx- Tx+ Tx- 7 8 9 10	Inputs
		Rx+
		Rx-
		Tx+
		Tx-

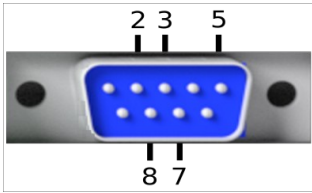
Table 32: COM1 Pin Connections

D.2.2.2. COM2-COM3

	COM2: RS-485 COM3: RS-232 A B GND Rx Tx GND 11 12 13 14 15 16	Inputs
		A
		B
		GND
		Rx
		Tx
		GND

Table 33: COM2- COM3 Pin Connections

D.2.2.3. Digital Inputs/Outputs

	Giriş	Comment	Connection Scheme																																
 <table border="1" data-bbox="225 974 699 1052"> <tr> <td>27</td><td>26</td><td>25</td><td>24</td><td>23</td><td>22</td><td>21</td><td>20</td><td>19</td><td>18</td><td>17</td> </tr> <tr> <td>DO-</td><td>DO4</td><td>DO3</td><td>DO2</td><td>DO1</td><td>DO+</td><td>DI4</td><td>DI3</td><td>DI2</td><td>DI1</td><td>+/-</td> </tr> <tr> <td colspan="5" style="text-align: center;">DO</td> <td colspan="5" style="text-align: center;">DI</td> </tr> </table>	27	26	25	24	23	22	21	20	19	18	17	DO-	DO4	DO3	DO2	DO1	DO+	DI4	DI3	DI2	DI1	+/-	DO					DI					DO-	Digital Output Supply -	
	27	26	25	24	23	22	21	20	19	18	17																								
	DO-	DO4	DO3	DO2	DO1	DO+	DI4	DI3	DI2	DI1	+/-																								
	DO					DI																													
	DO4	Digital Outputs																																	
DO3																																			
DO2																																			
DO1																																			
DO+	Digital Output Supply+																																		
	DI4	Digital Inputs																																	
	DI3																																		
	DI2																																		
	DI1																																		
	+/-	NPN / PNP Selection of Digital Inputs																																	

Table 34: Digital Input/Output Pin Connection

D.2.3. Pin Connections PROOP 10" Models

D.2.3.1. COM1-COM2

<p>COM1: RS-422 COM2: RS-485</p> <table border="1"> <tr> <td>Rx+</td> <td>Rx-</td> <td>Tx+</td> <td>Tx-</td> <td>GND</td> <td>A</td> <td>B</td> <td>GND</td> </tr> <tr> <td>7</td> <td>8</td> <td>9</td> <td>10</td> <td>11</td> <td>12</td> <td>13</td> <td>14</td> </tr> </table>	Rx+	Rx-	Tx+	Tx-	GND	A	B	GND	7	8	9	10	11	12	13	14	Inputs
	Rx+	Rx-	Tx+	Tx-	GND	A	B	GND									
	7	8	9	10	11	12	13	14									
	Rx+																
	Rx-																
	Tx+																
	Tx-																
	GND																
A																	
B																	
GND																	

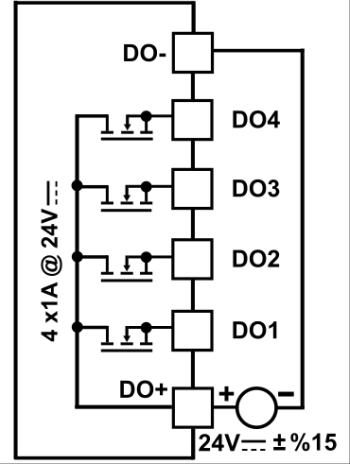
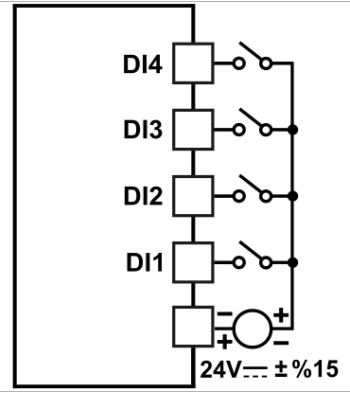
Table 35: COM1- COM2 Pin Connections

D.2.3.2. COM3

<p>COM3: RS-232</p> <table border="1"> <tr> <td>Rx</td> <td>Tx</td> <td>GND</td> </tr> <tr> <td>15</td> <td>16</td> <td>17</td> </tr> </table>	Rx	Tx	GND	15	16	17	Inputs
	Rx	Tx	GND				
	15	16	17				
Rx							
Tx							
GND							

Table 36: COM3 Pin Connections

D.2.3.3. Analog/Digital Inputs

	Inputs	Comment	Connection Scheme																														
 <table border="1" data-bbox="197 887 584 965"> <tr> <td>27</td><td>26</td><td>25</td><td>24</td><td>23</td><td>22</td><td>21</td><td>20</td><td>19</td><td>18</td> </tr> <tr> <td>AI2-</td><td>AI2+</td><td>AI1-</td><td>AI1+</td><td>DI5</td><td>DI4</td><td>DI3</td><td>DI2</td><td>DI1</td><td>+/-</td> </tr> <tr> <td colspan="4">AI</td> <td colspan="6">DI</td> </tr> </table>	27	26	25	24	23	22	21	20	19	18	AI2-	AI2+	AI1-	AI1+	DI5	DI4	DI3	DI2	DI1	+/-	AI				DI						AI2-	Analog Input2 -	
	27	26	25	24	23	22	21	20	19	18																							
	AI2-	AI2+	AI1-	AI1+	DI5	DI4	DI3	DI2	DI1	+/-																							
	AI				DI																												
	AI2+	Analog Input2 +																															
AI1-	Analog Input1 -																																
AI1+	Analog Input1 +																																
DI5	Digital Inputs																																
DI4																																	
DI3																																	
DI2																																	
DI1																																	
+/-	NPN / PNP Selection of Digital Inputs																																

Table 37: Analog Inputs Pin Connections

D.2.3.4. Analog/Digital Outputs

	Inputs	Comment	Connection Scheme																														
 <table border="1" data-bbox="183 918 582 996"> <tr> <td>37</td><td>36</td><td>35</td><td>34</td><td>33</td><td>32</td><td>31</td><td>30</td><td>29</td><td>28</td> </tr> <tr> <td>AO+</td><td>AO-</td><td>AO2</td><td>AO1</td><td>DO-</td><td>DO4</td><td>DO3</td><td>DO2</td><td>DO1</td><td>DO+</td> </tr> <tr> <td colspan="5">AO</td> <td colspan="5">DO</td> </tr> </table>	37	36	35	34	33	32	31	30	29	28	AO+	AO-	AO2	AO1	DO-	DO4	DO3	DO2	DO1	DO+	AO					DO					AO+	Analog Output Supply +	
	37	36	35	34	33	32	31	30	29	28																							
	AO+	AO-	AO2	AO1	DO-	DO4	DO3	DO2	DO1	DO+																							
	AO					DO																											
	AO-	Analog Output Supply -																															
AO2	Analog Outputs																																
AO1																																	
DO-	Digital Output Supply -																																
DO4	Digital Outputs																																
DO3																																	
DO2																																	
DO1																																	
DO+	Digital Output Supply +																																

Table 38: Analog Outputs Pin Connections

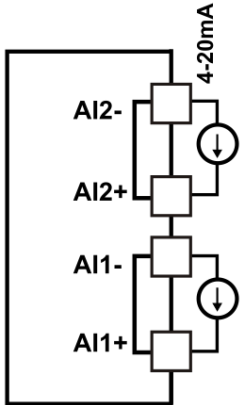
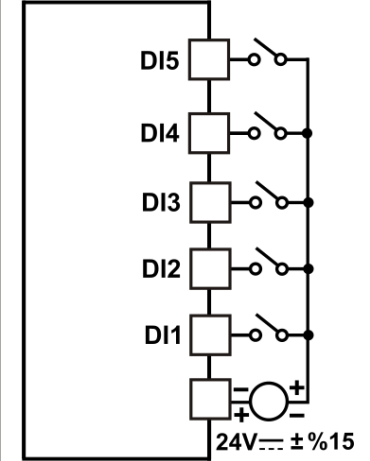
D.2.4. Internal I/O Address Definitions

Device Type	Format	Range
Digital Input	\$Ixn.k	n: 0-0 k: 0-4
Digital Output	\$Qxn.k	n: 0-0 k: 0-5
Analog Input	\$IWn	n: 0-1
Analog Output	\$MWn	n: 0-1

Table 39: Internal Input / Output Address Definitions

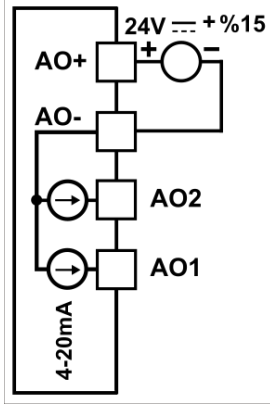
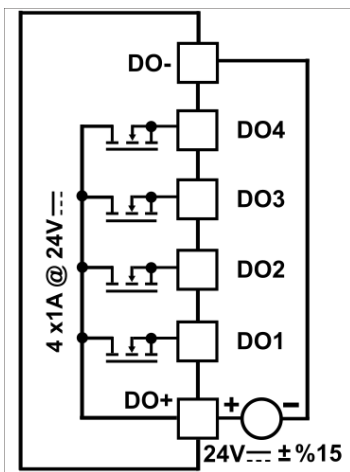
D.2.5. Internal Memory Address Definitions

Device Type	Format	Range
Volatile Memory	\$n	n: 0-65535
Non-Volatile Memory	\$Mn	n: 0-65535
Volatile Memory Bit	\$n.k	n: 0-65535 k: 0-15
Non-Volatile Memory Bit	\$Mn.k	n: 0-65535 k: 0-15
Internal Settings	\$Sn	n: 0-65535

Table 40: Internal Memory Addresses

D.3. Supported Communication Protocols

Protocols supported by PROOP are addressed.

Supported protocols are listed in the table below.

	Brand	Protocols
1	MODBUS	Modbus-RTU
2	MODBUS	Modbus-ASCII
1	MODBUS	Modbus TCP/IP
2	MODBUS	Modbus-ASCII(Slave)
1	MODBUS	Modbus-RTU(Slave)
2	MODBUS	Modbus TCP/IP(Slave)
3	SIEMENS	S7-200(PPI)
4	SIEMENS	S7-300(ISOTCP)
5	SIEMENS	S7-400(ISOTCP)
6	SIEMENS	S7-1200(ISOTCP)

Table 41: Supported Brands

D.3.1. MODBUS Master Address Definitions

Address formats and address ranges are listed for devices using the Modbus communication protocol in the table below.

Device Type	Format	Range	Type
Discreate Output Coils	1000n	n: 1-65535	Read-Write
Discreate Input Coils	2000n	n: 0-65535	Read
Input Registers	3000n	n: 0-65535	Read
Holding Registers	4000n	n: 0-65535	Read-Write
Holding Bit	4000n.k	n: 0-65535 k: 0-15	Read-Write
Input Bit	3000n.k	n: 0-65535 k: 0-15	Read
Holding Registers (Write Multi)	WMn	n: 0-65535	Read-Write

Table 42: MODBUS-RTU Address Definitions

D.3.2. MODBUS Slave Address Definitions

Standard

Internal Memory Name	Modbus Address Range		Modbus Functions
	Start	End	
Volatile Memory	40001	42000	3,6,16
Non-Volatile Memory	42001	44000	3,6,16
Analog Outputs	44001	44002	3,6,16
Internal Settings	45001	45500	3,6,16

Extended

Internal Memory Name	Modbus Address Range		Modbus Functions
	Start	End	
Volatile Memory	410001	420000	3,6,16
Non-Volatile Memory	420001	430000	3,6,16
Analog Outputs	435001	435500	3,6,16
Internal Settings	450001	455000	3,6,16

Internal Memory Name	Modbus Address Range		Modbus Functions
	Start	End	
Analog Inputs	30001	30002	4

Internal Memory Name	Modbus Address Range		Modbus Functions
	Start	End	
Digital Outputs	00001	00004	1,5,15

Internal Memory Name	Modbus Address Range		Modbus Functions
	Start	End	
Digital Inputs	10001	10004/10005*	2

NOT*: 5th digital input only available on Proop.10P and Proop.10P.E

E) PROOP Upgrade

PROOP device is upgraded to the current version with Usb connection.

You can upgrade firmware with following the steps below.

- <http://www.emkoelektronik.com.tr/> Download the update file from the Download Center → Software section of the website.
- Or <http://www.proopforum.com/> download the update file from Proop Forum Site Technical Docs → Proop HMI Firmware Update.

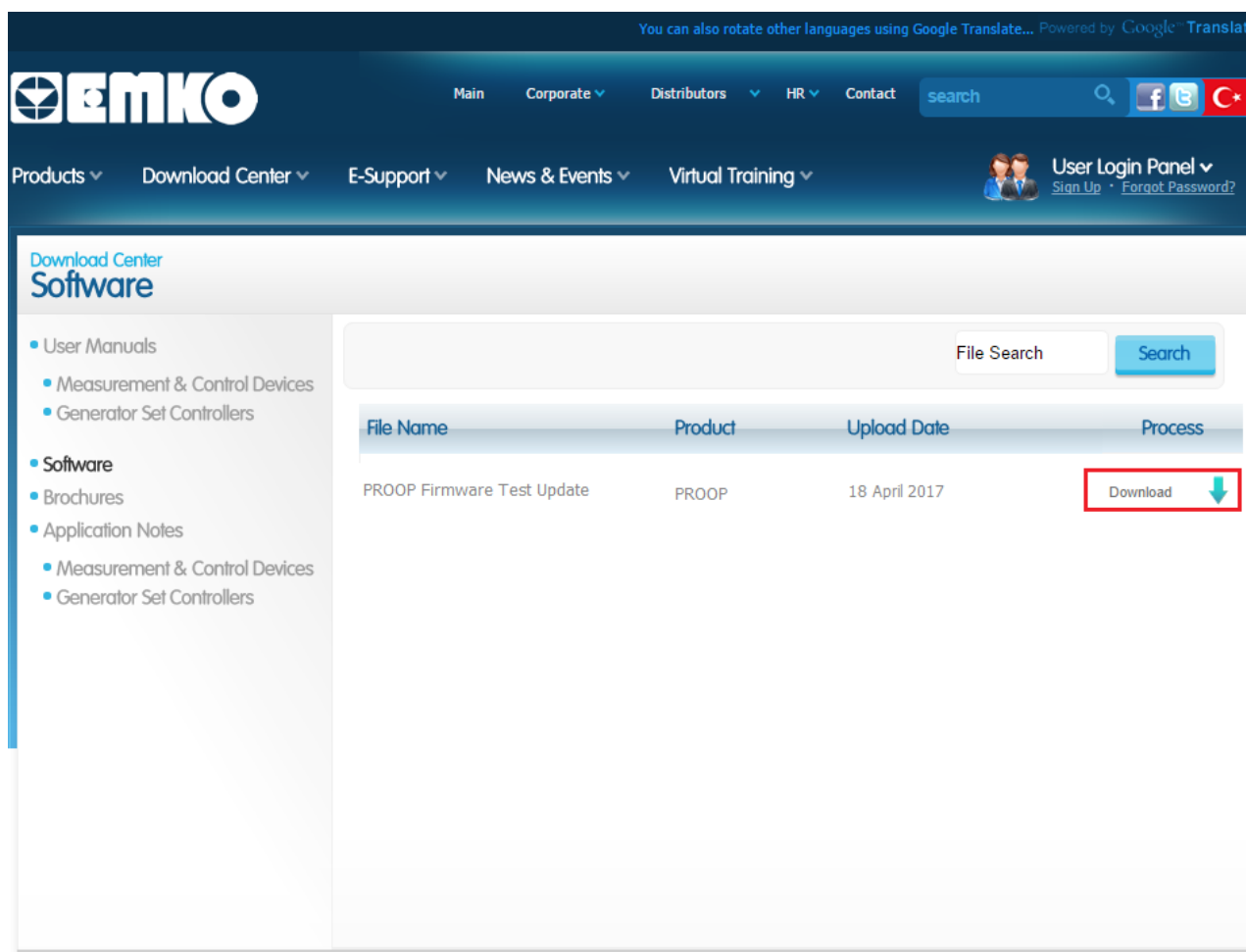

The screenshot shows the EMKO website's 'Download Center Software' page. The page features a navigation menu with 'Download Center' selected. A sidebar on the left lists categories: 'User Manuals' (Measurement & Control Devices, Generator Set Controllers) and 'Software' (Brochures, Application Notes, Measurement & Control Devices, Generator Set Controllers). A search bar is present. Below the search bar is a table with the following data:

File Name	Product	Upload Date	Process
PROOP Firmware Test Update	PROOP	18 April 2017	Download ↓

Picture 72: Access Site For Software Source

- Copy the compressed file '**update.tar.gz**' in the downloaded zip file to the **main directory** of the usb memory.
- Plug the usb memory into the USB port on the back of the device.
- If you cut off the power of the device and you give it again, the installation process will start.
- You can follow the installation process on the device screen as in Picture-65 below.

```
Update (tar) started, please wait...
emko/runtime/libEmkoHmi.so.1.0.0
emko/runtime/hmi_protocols/libinternal.so
usr/lib/fonts/arial.ttf
Update successful!!!
```

Picture 73: Software Update

F) HMI Settings



You can follow the steps below to view and edit the Ethernet settings on the PLC screen.

- Drag any of the button elements to the project page you are using in the Proop Builder program.
- To configure the button, select the button type in the button section of the properties list as '*HMI settings*' as below.

Button Type	Push Button
State Type	Checkable
Page Function	Set
Auto Repeat Interval	Reset
Auto Repeat Delay	Set Value
Auto Repeat	Set Constant
autoExclusive	Multi State
Checkable	Increment
Checked	Decrement
shortcut	
Set Value	HMI Settings

- Click on 'online simulation' from online simulation tools.
- Network settings is shown as default tab.
- The screens of the HMI settings are displayed as follows

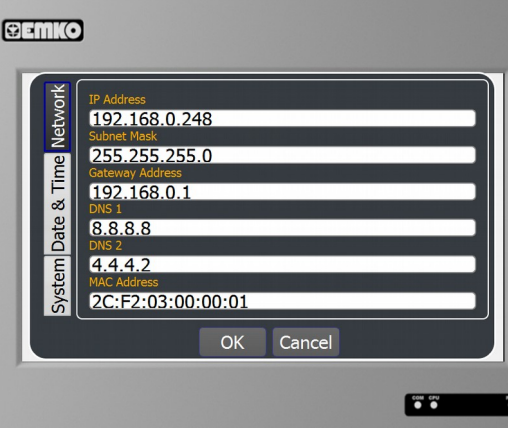
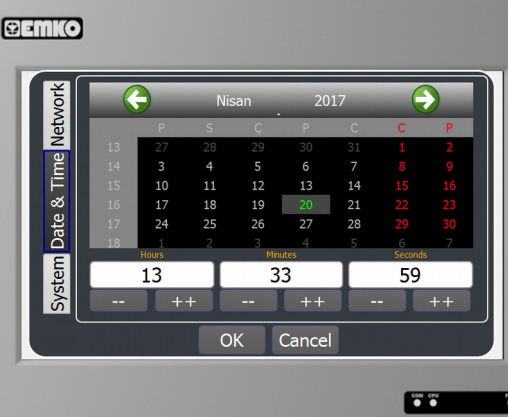

Tabs	HMI Settings Screens	
<p>Network Settings</p>		<p>The device information are IP address, subnet mask, DNS 1 and DNS 2.</p> <p>The user can edit this information.</p> <p>The MAC address can not be edited and is shown as read only.</p>
<p>Date & Time</p>		<p>Displays the current time and date.</p> <p>The user can edit time and date.</p>
<p>System</p>		<p>Buzzer: Adjust the buzzer sound.</p> <p>The left button is OFF, The right button is ON.</p> <p>Brightness: Adjust the brightness.</p> <p>The button increases the brightness from left to right and the maximum value is 7.</p> <p>The button decreases from right to left and minimum value is 0.</p>

Picture 74: HMI Settings

G) Defining System Settings by Addressing

G.1. Brightness

You can follow the steps below to view and edit the screen brightness of the PLC screen.

- Drag and drop the scroll bar element to the page of the project you are using in the Proop Builder program.
- To edit the scroll bar, click the icon displayed on the right in the properties list-> address-> write address.  A new window will open as below.

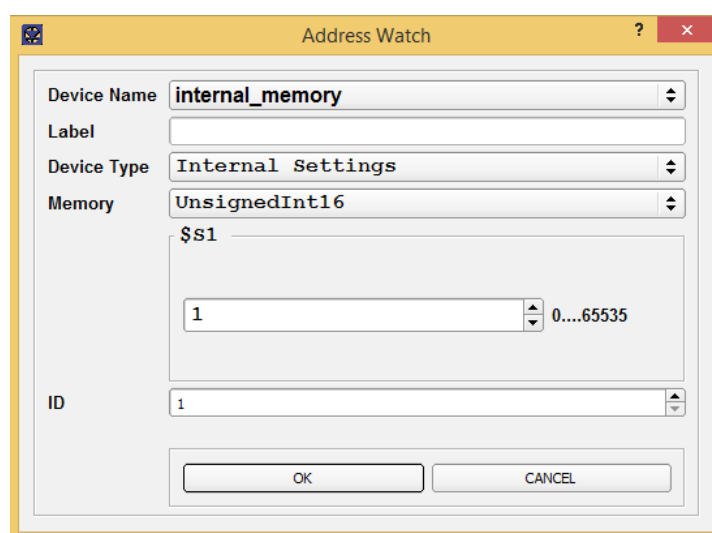

Picture 75:Address Watch(Brightness)

- Select device name '**internal_memory**' as above.
- Select the device type '**Internal Settings**', and the memory is displayed as '**\$S1**'.
- Write the deviceID in the ID field and click the "**Ok**" button.
- The write address field is displayed as follows.

- Address	
+ Read Address	
+ Hide Address	
- Write Address	internal_memory@\$S1
slaveid	1
addresstype	UnsignedInt16

- To specify the minimum and maximum limits of the brightness value, edit the properties list-> data section. It can be edited as follows.

Set Value	
Value	1.000000
Constant Value	1.000000
Max	7.000000
Min	1.000000

- Click on 'online simulation' from the tools.
- The brightness setting is displayed as below.

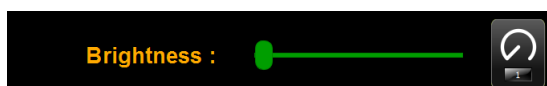

Picture 76: Brightness

G.2. Buzzer

To view and edit the PLC buzzer status, you can follow the steps below.

- Drag and drop the Switch 2 element onto the page of the project you are using in the Proop Builder program.
- To edit the Switch 2 element, click on the icon displayed on the right in the properties list-> address-> write address.  A new window will open as below.

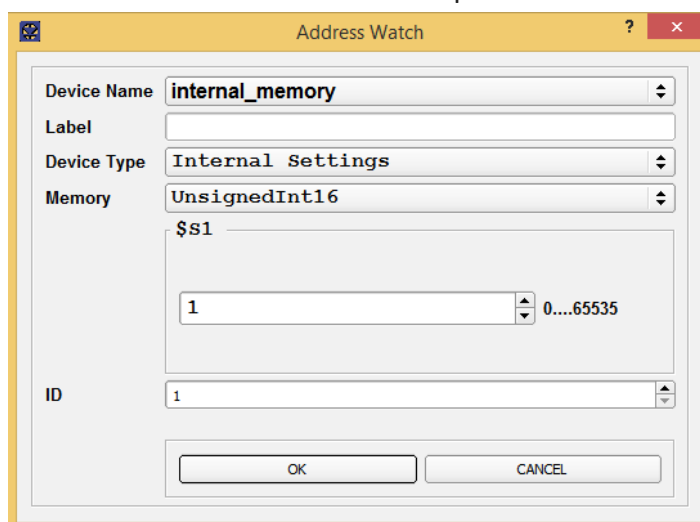

Picture 77: Address Watch(Buzzer)

- Select device name '**internal_memory**' as above.
- Select the device type '**Internal Settings**' and the memory is displayed as '**\$\$0**'.
- Write the deviceID in the ID field and click the "**Ok**" button.
- The write address field is displayed as follows.

Property	Value
Address	
Read Address	
Write Address	internal_memory@\$0
slaveid	1
addresstype	UnsignedInt16

- Click on 'online simulation' from the tools.
- The buzzer setting is displayed as below.

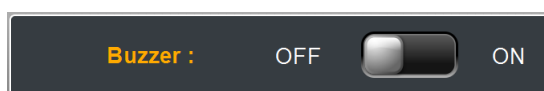

Picture 78: Buzzer

H) Create An Application

To create an application at this part, the steps to be done will be explained.

Action to be performed;

- Add a new project and a device.
- Edit connection points information of the device.
- Add a new page of the project and add desired the element tools.
- Define the read or write address of the inserted element.
- Edit the properties section and visual of the element tool.

H.1. Create A New Project

To create a new project;

- Click the project from menu tool and click the '**New**' from is the opened sub menu

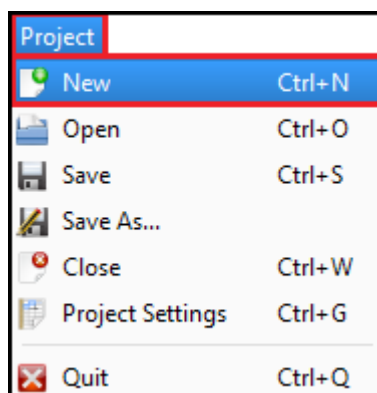

- Write a new project name the '**Folder Name**' field and save.

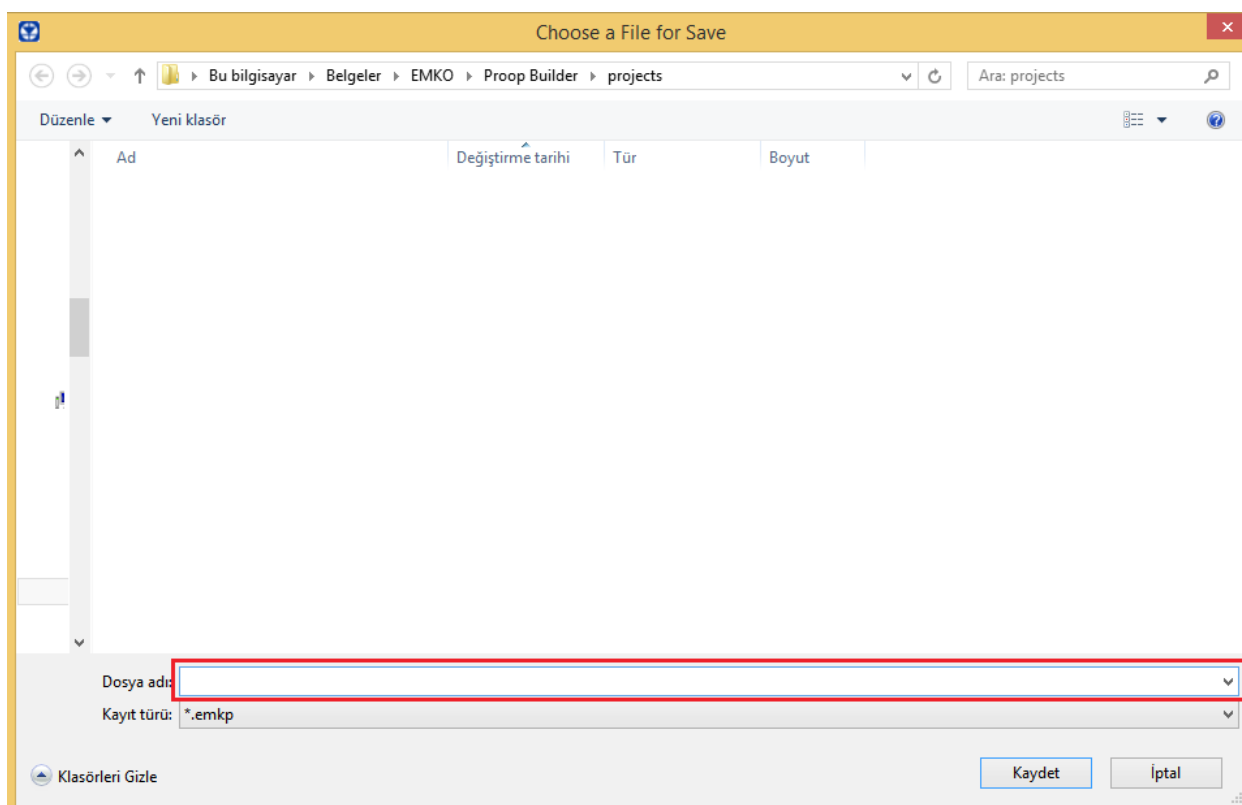

Picture 79: Project-1

The form window opens after saving the project.

- Select a model as below and click the '**kaydet**' button.

Models are explained in detail under the heading of '**model list**'.

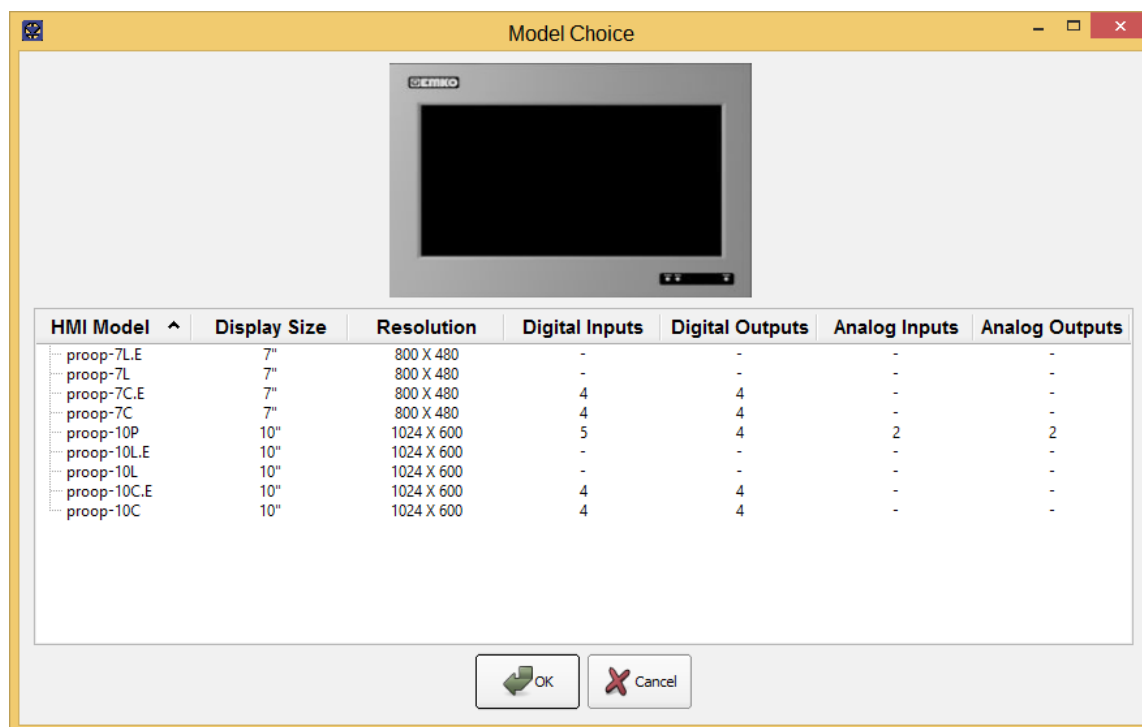

Picture 80: HMI Models

- Screen editor is closed and program is restarted and the added project is opened automatically.

H.2. Add A New Device

To add a new device at the project;

- Click the options from menu tool and click communication settings from sub menu.

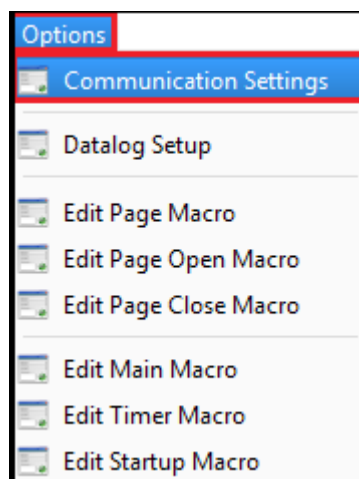

Picture 81: Options->Communication Settings

- The communication settings that are opened will contain the setting information for about the devices to be added

- The communication settings are as shown in Picture-73.

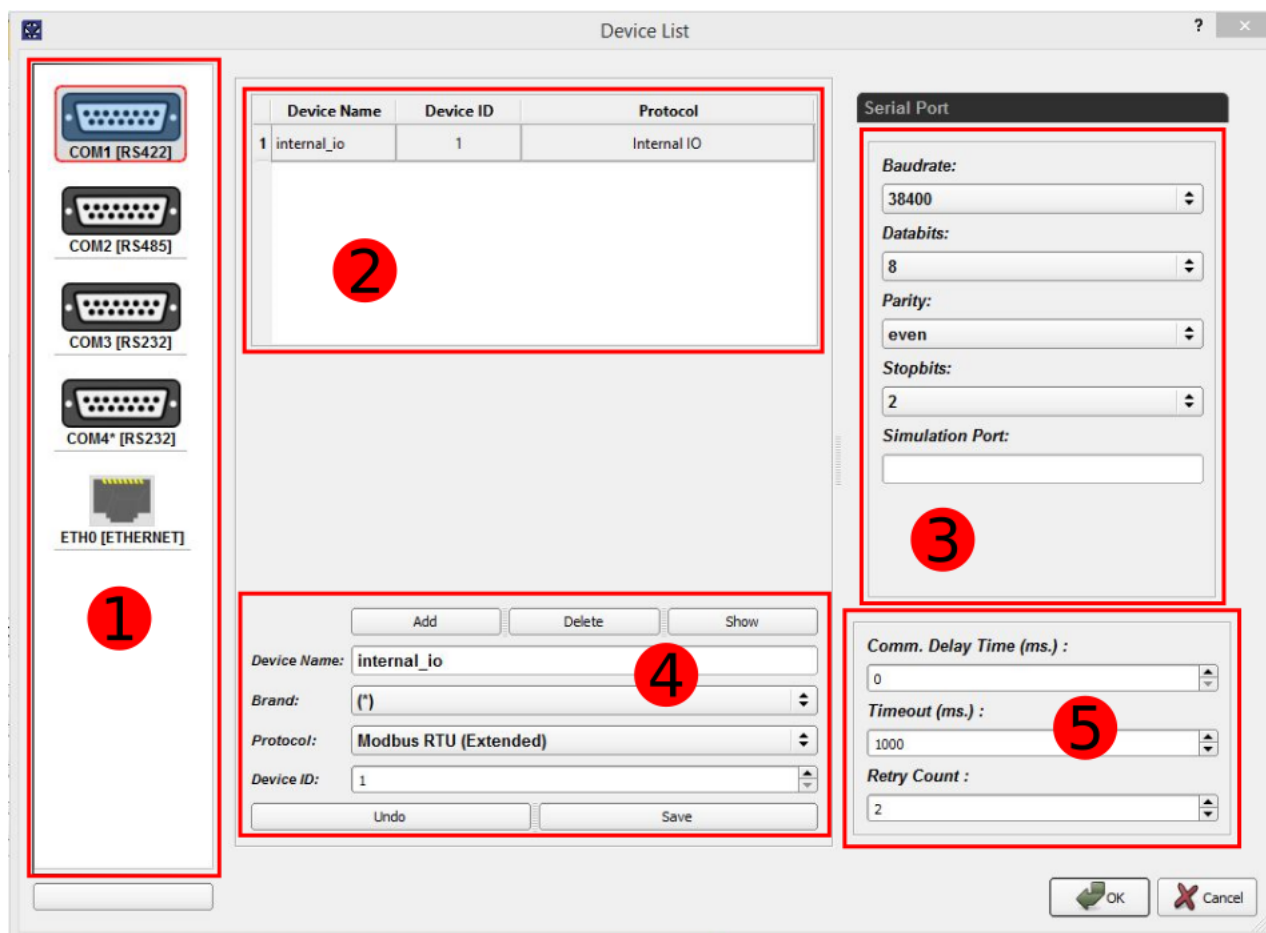

Picture 82: Device Lists

- Select the '**connection point of the device**' to be added from the field number 1.

The list of connection point options includes COM1 (RS232), COM2 (RS485), COM3 (RS232), COM4 (RS232) and ETH0 (ETHERNET).

You can access detailed information of the connection points from 'Pin Connections'.

- Enter the device name, brand, protocol and deviceID information from field number 4 and click '**Add**' button.
- The added device is listed in field 2 and edit the serial port settings from field number 3.

The simulation port field in the serial settings specifies the PC comport to be used during online simulation.

- Finally, edit the options for the connection in field number 5 and click the '**Save**' button to update the device information.

H.3. Add A New Page

To create a new page (form);

- Click on the '**Create New Form**' icon from the toolbar at the top of the editor screen.



- The screen editor section displays the form screen named Page_1 by default.
The page can be updated from the '**Object Name**' field in the general section of the list of name properties
- Pages can increase at the desired count.

Property	Value
- General	
Object Name	Page_1
locale	Turkish, Turkey
Language	Turkish
Country	Turkey
Enabled	<input checked="" type="checkbox"/>
+ Visual	
+ Macro	
+ Geometry	

H.4. Add An Element Tool And Edit Property List

Adding elements to the page and editing the list of properties will be explained with examples.

Example-1(Lcd Number)

In example-1, data will be displayed from the address field defined by the LCD number element. After incrementing or decrementing the data value with the help of the buttons/Increment value-Decrement value, writing at the address will be done.

H.4.1. Define Read / Write Address Of Element

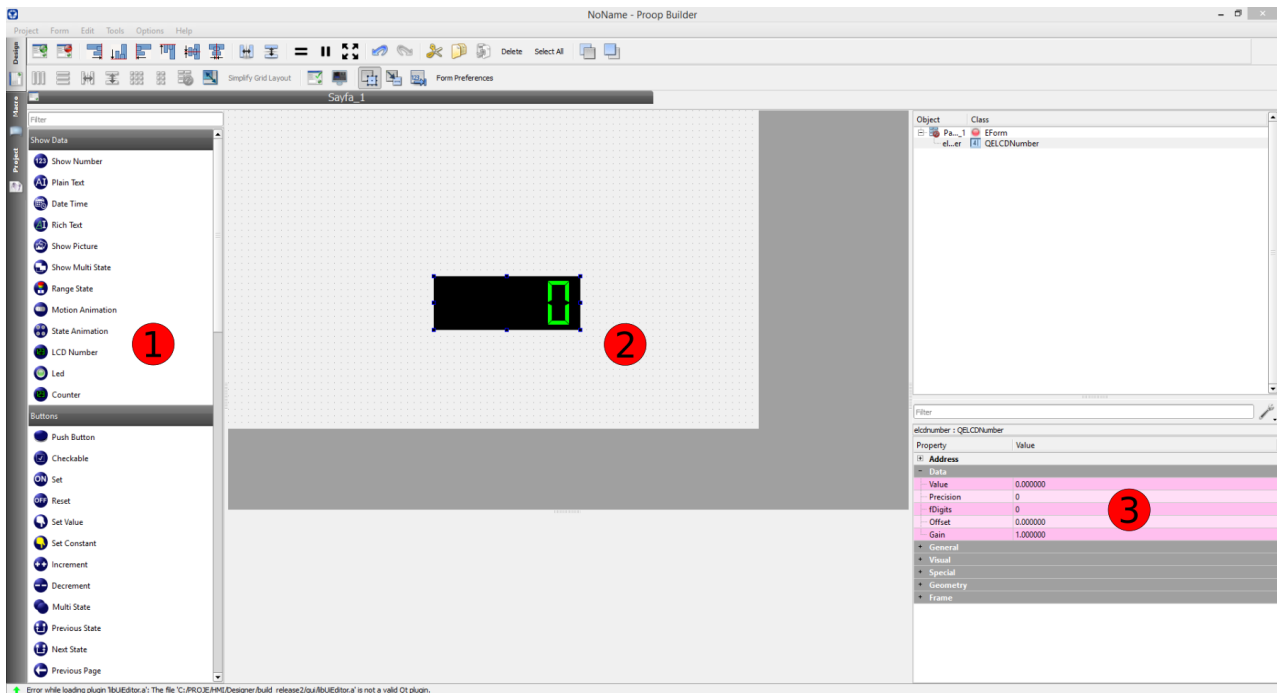

Picture 83: Screen Editor

The LCD number element is specified as the element to be used for data display.

The decrease button and the increase button will be used to set the value at the write address field after the value changed operation.

- In section 1, click on the element you want to use and drag and drop the section number 2.
- Click on the '**Read Address**' field in the address field from the list of properties number 3.

Property	Value
- Address	
+ Read Address	<input type="text"/>
+ Hide Address	
- Write Address	
slaveid	1
address type	UnsignedInt16

-  When the icon on the left is shown, click on the icon and address watching form will open as the following Picture-71.

- Select the device named '**Device1**' that is added in the device name field

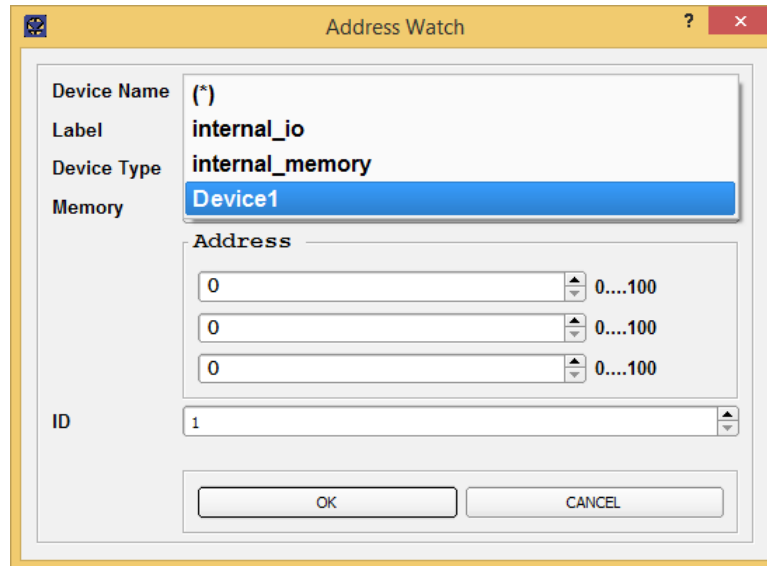

Picture 84: Address Watch

- The device type lists the functions of the access addresses in the memory area and the required device type is determined.
- You can access device details under the heading Device types.

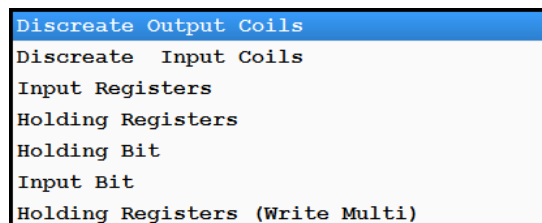

- Listed the memory and value type is specified the desired type.

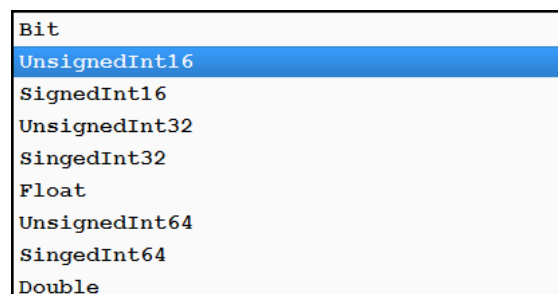

- Enter ID, deviceID of the device and click '**okey**' button as the read address value.

The above operations is applied at the increase button and the decrease button. So that, this is done by writing the changed data value with the help of buttons.

H.4.2. Add An Image Of Element

To add an image on the buttons;

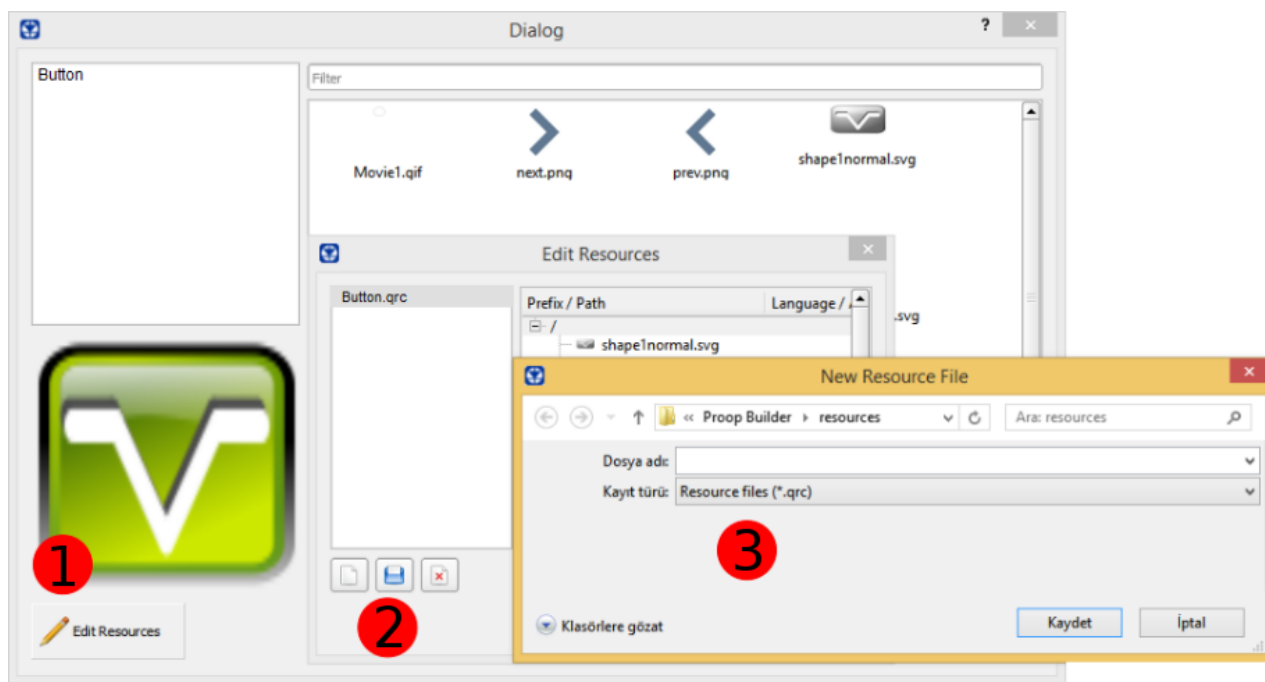

Picture 85: Resources

- First, a new library will be created to add images to the buttons. Click on the tools resource editor in the menu bar for this.
- Click on '**Edit resources**' from field 1.
- Click '**Create New Resources File**' in field 2 from the new window that opens.
- Define '**File name**' in field 3 again from the new window that opens.

- 'Create New Resource File' windows is closed and you are returned to the 'Edit Resources' window.

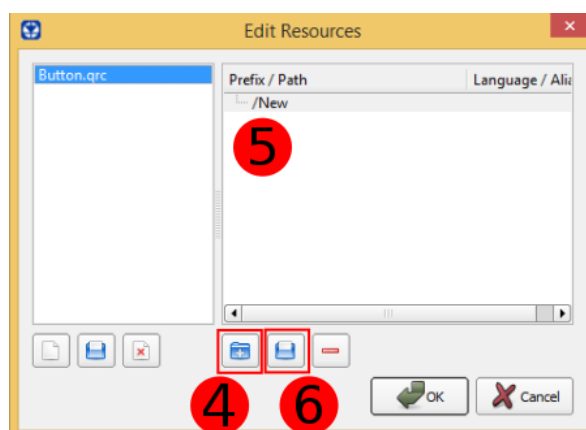

Picture 86: Edit Resources

- Click '**Add Prefix**' from the field number 4 to insert an image.
- Define the new path name in field number 5.
- Click the '**Add Files**' from the field number 6.
- Select the image on opened the '**add files**' window and click the '**Open**' button.
- After closing the window, go back to the '**edit resource**' window and click on the '**OK**' button and the image file is created.

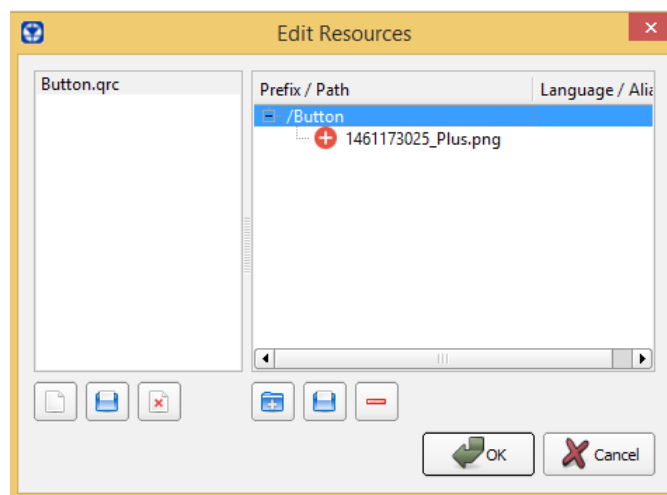

Picture 87: Edit Resources

- To load image into the buttons, select '**Flat**' field number 1 .

- Once click on the '**Picture**' field number 2, click on the icon on the right and click on it.

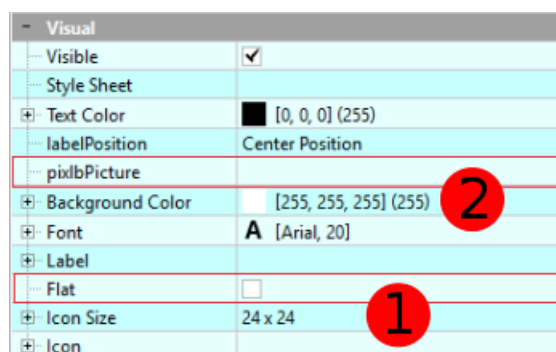

- The new window that opens is the image files window. Select what you want to upload as in Picture-75.

For the example-1 (Lcd Number) made, another value decrement button is added and the image uploading process is completed.

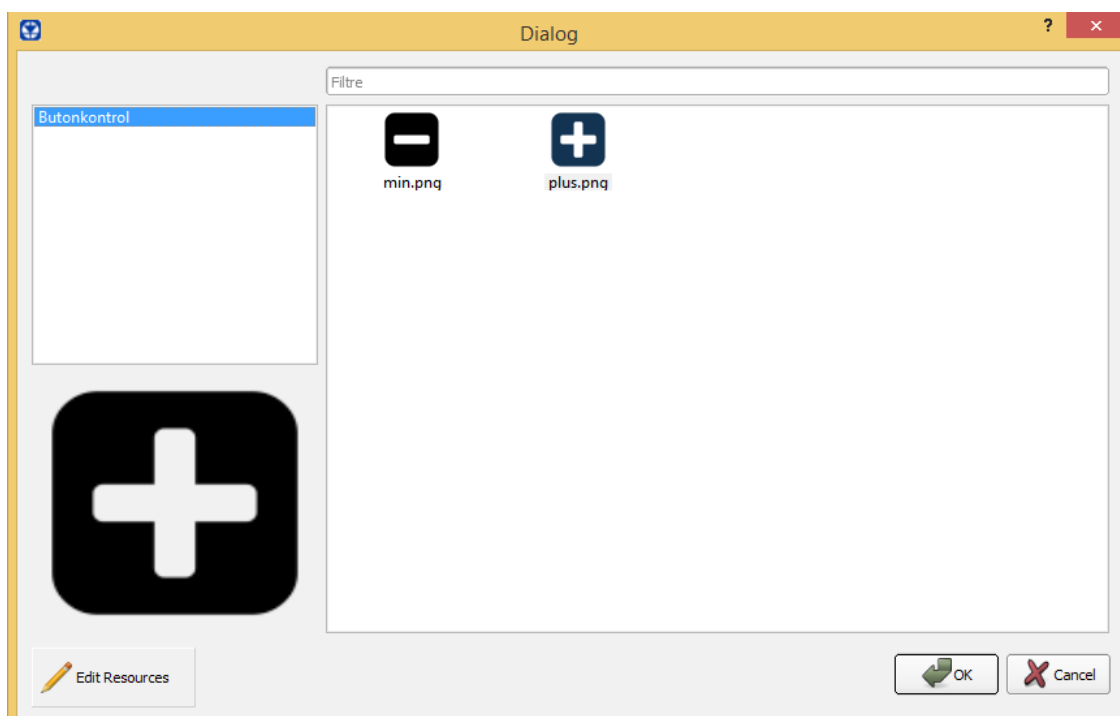

Picture 88: Edit Resources

To define the amount of the increase or decrease buttons;

- The **'constant value'** field is shown below. Set the desired amount from this area.

Set Value	
Value	1.000000
Constant Value	1.000000
Max	100.000000
Min	0.000000

According to the value in the constant value field, the lcd number element data value changes as the button is clicked. This value is written to the write address.

H.4.3. Define States Of Element

The operation of determining the state of the elements will be explained with Example-2 .(Multiple Status Indicator Alarm-Running).

Example-2(Multi State)

The multi-state display element will be used to display different properties for each state

Actions to be performed;

- Create a new project. It is explained in detail under the heading **'Create A New Project'**.
- Add a device. It is explained in detail under the heading **'Add A New Device'**.
- Add a new page. It is explained in detail under the heading **'Add A New Page '**.
- Add the desired element tool (multi state). It is explained in detail under the heading **'Add An Element Tool And Edit Property List'**.
- The read address field is defined in the multi state element. It is explained in detail under the heading **'Define Read / Write Address Of Element'**.
- Determine view or function for each state of the address read.

Selection of active status visual property selection;

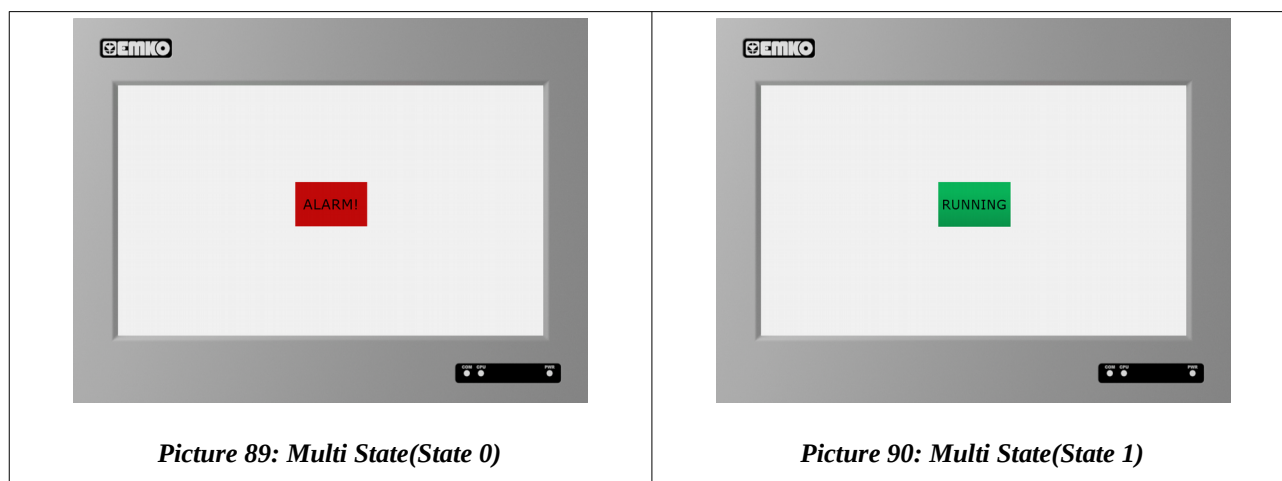

Picture 89: Multi State(State 0)

Picture 90: Multi State(State 1)

- You can disable the **'visible'** field selection and use the element hiding feature according to the current state.
- You can use these properties according to the active status by clicking on the **'Text'** field and writing text, alignment, font, font color, background color.
- You can use this properties according to the active state by selecting the desired picture from the resources opened by clicking on the **'pixlbPicture'** field.

- Visual	
Visible	<input checked="" type="checkbox"/>
Style Sheet	
+ Text Color	■ [0, 0, 0] (255)
labelPosition	Center Position
pixlbPicture	
+ Background Color	■ [255, 255, 255] (255)
+ Font	A [Arial, 20]
+ Label	
Flat	<input type="checkbox"/>
+ Icon Size	24 x 24
+ Icon	

To determine the state;

- Set the number of states from the **'nStates'** field. In Example-2, the number of states is entered as 2.
- Define the value of the active status you want to edit in the **'Current State'** field.
- For each state, enter the state property as the number of states.

The *'Image', 'Background Color', 'Font'* and *'Text'* fields are edited for the current state 0 and are displayed on the screen as an alarm.



State	Current State:0
<p align="center">Properties List General Section</p>	
<p align="center">Properties List Visual Section</p>	
<p align="center">Multi State View</p>	

Table 43: Multi State(Current State:0-Alarm)

The *'Image'*, *'Background Color'*, *'Font'* and *'Text'* fields are edited for the current state 1 and are displayed on the screen as running.

State	Current State:1																								
Properties List General Section	<table border="1"> <tr> <td>Current State</td> <td>1</td> </tr> <tr> <td>nStates</td> <td>2</td> </tr> </table>	Current State	1	nStates	2																				
Current State	1																								
nStates	2																								
Properties List Visual Section	<table border="1"> <tr> <td colspan="2">Visual</td> </tr> <tr> <td>Visible</td> <td><input checked="" type="checkbox"/></td> </tr> <tr> <td>Style Sheet</td> <td></td> </tr> <tr> <td>+ Text Color</td> <td>■ [0, 0, 0] (255)</td> </tr> <tr> <td>labelPosition</td> <td>Center Position</td> </tr> <tr> <td>pixlbPicture</td> <td>■ green.png</td> </tr> <tr> <td>+ Background Color</td> <td>■ [255, 255, 255] (255)</td> </tr> <tr> <td>+ Font</td> <td>A [Arial, 20]</td> </tr> <tr> <td>+ Label</td> <td>RUNNING</td> </tr> <tr> <td>Flat</td> <td><input type="checkbox"/></td> </tr> <tr> <td>+ Icon Size</td> <td>24 x 24</td> </tr> <tr> <td>+ Icon</td> <td></td> </tr> </table>	Visual		Visible	<input checked="" type="checkbox"/>	Style Sheet		+ Text Color	■ [0, 0, 0] (255)	labelPosition	Center Position	pixlbPicture	■ green.png	+ Background Color	■ [255, 255, 255] (255)	+ Font	A [Arial, 20]	+ Label	RUNNING	Flat	<input type="checkbox"/>	+ Icon Size	24 x 24	+ Icon	
Visual																									
Visible	<input checked="" type="checkbox"/>																								
Style Sheet																									
+ Text Color	■ [0, 0, 0] (255)																								
labelPosition	Center Position																								
pixlbPicture	■ green.png																								
+ Background Color	■ [255, 255, 255] (255)																								
+ Font	A [Arial, 20]																								
+ Label	RUNNING																								
Flat	<input type="checkbox"/>																								
+ Icon Size	24 x 24																								
+ Icon																									
Multi State View																									

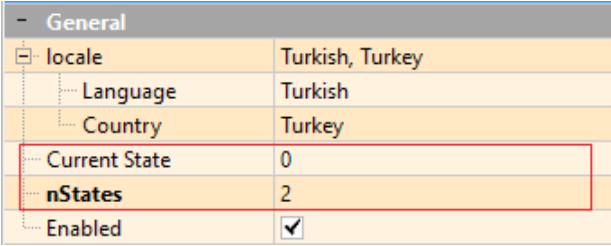
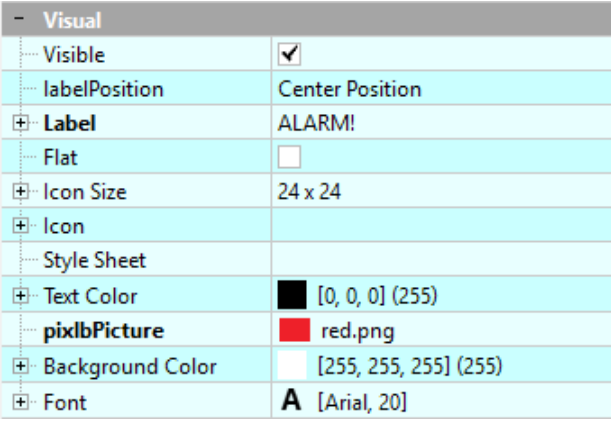
Table 44: Multi State(Current State:1-Running)

Example-3 (Multi State-Display if Alarm)

A state will be hidden and other state will be displayed with the multi state element tool.

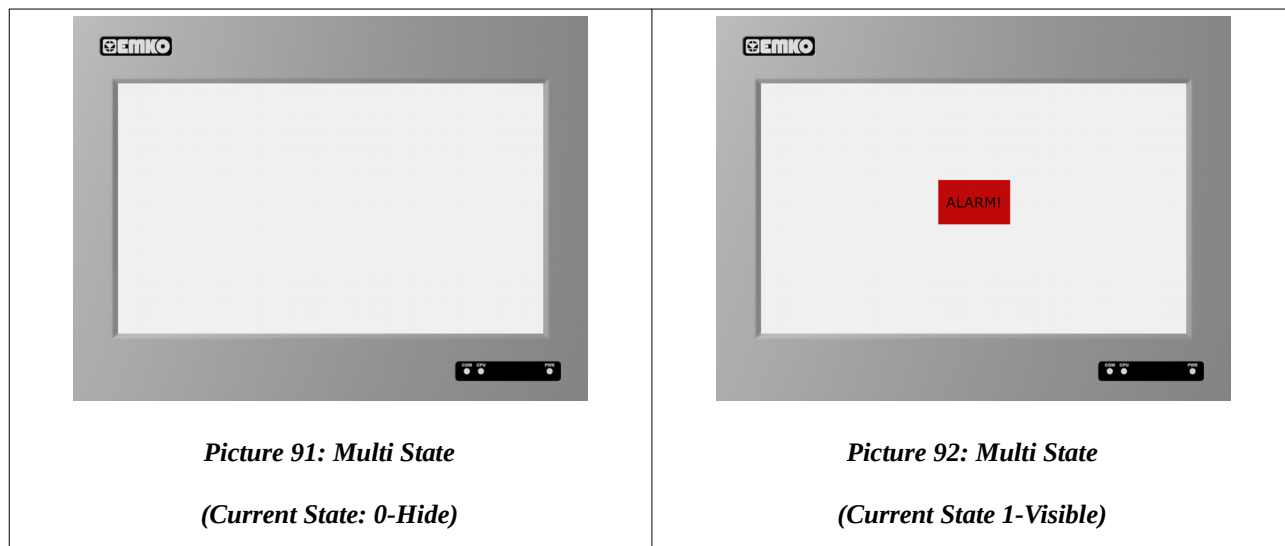

Disable the **'visible'** field of the visual section to state 0.

State	State: 0
<p>Properties List General Section</p>	
<p>Properties List Visual Section</p>	
<p>Multi State View</p>	<p>Hidden element tool</p>

Table 45: Multi State(State: 0-No alarm)

Edit the **'pplxPicture'**, **'Background Color'**, **'Font'** and **'Label'** fields. Element tool is display as an alarm.

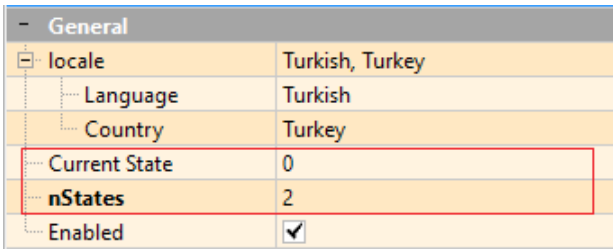
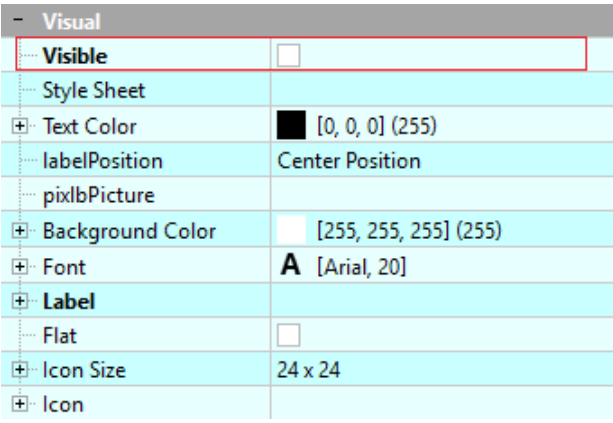

State	State: 0
<p>Properties List General Section</p>	
<p>Properties List Visual Section</p>	
<p>Multi State View</p>	

Table 46: Multi State(State: 0-There is an alarm)

Example-4(Range State)

Actions to be performed;

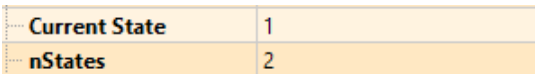
- Add a new page the current project. It is explained in detail under the heading '**Add A New Page**'.
- A range state element tool is add the page. It is explained in detail under the heading '**Define Read / Write Address Of Element**'.
- Determine the range values for for each state of the read address.

The current state of the battery will be displayed by using a range state element



Picture 93: Range State
(Current State: 0-Low)



Picture 94: Range State
(Current State: 1-Half)



Picture 95: Range State
(Current State: 2-Quarter-full)



Picture 96: Range State
(Current State: 3-Full)

To determine the state;

- Set the number of states from the '**nStates**' field. This example, the number of states is entered as 4.
- Set the status value you want to edit in the '**status**' field.
- Define a value in the '**Range**' field for each state and set the range limit. The status property is displayed until that limit.
- The visual property is edited by the number of states.

After the value is set in the number of states field;

1. While the value in the '**status**' field is '**0(zero)**', click on the '**pxlbPicture**' field in the visual section and select the desired image from the resources.

While the '**status**' field value is '**0(zero)**', define a value in the '**range**' field from the special section and so that the image is displayed on the screen until the defined limit.

2. Increase the status value by moving the value in the '**status**' field with the mouse or click on the '**status**' field and type '**1**' in the status field as the value. Click the '**pxlbPicture**' field in the visual section and select the desired image from the resources.





	Low	Half	Quarter Full	Full
nStates	4	4	4	4
State	0	1	2	3
Range	25	50	75	100
pxlbPicture				

Table 47: Range State(States)

Example-5 (Macro)

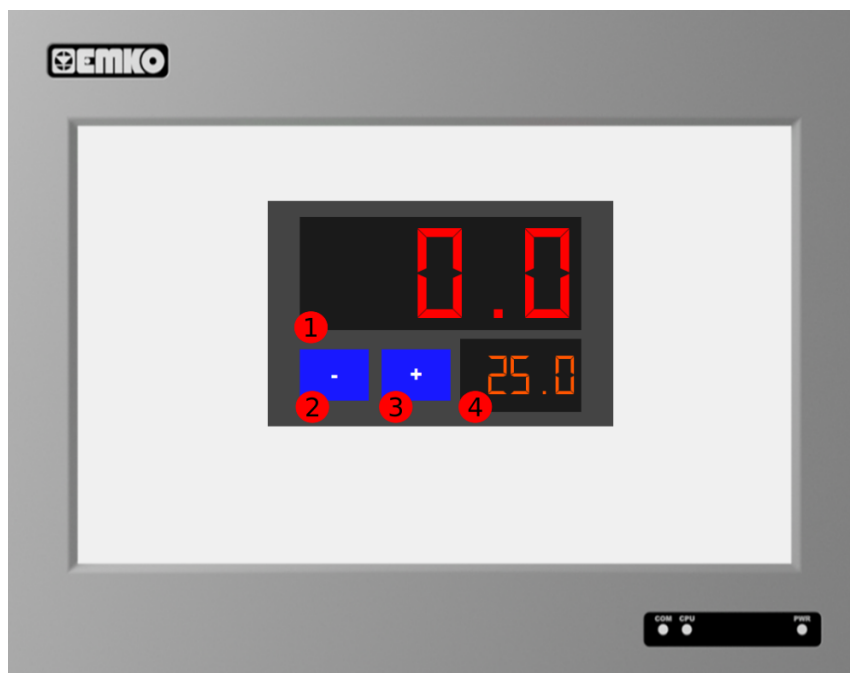

Picture 97: Macro Application

Element Tool Properties

	Used Element Tool	Read Address	Property
1	LCD Number	internal_memory@\$0 (Internal volatile memory address 0)	-
2	LCD Number	internal_memory@M0 (Internal volatile memory address 0)	-
3	Button/ Decrement	internal_memory@M0 (Internal volatile memory address 0)	Step Value:0.1
4	Buton/ Increment	internal_memory@M0 (Internal volatile memory address 0)	Step Value:0.1

Tablo 48: Read Address of the Used Element Tools

Code Main Macro

```

1      func main()                // Function main macro
2      $0 = %IW0 / 10.0;          // converting decimal display
3                                     // of the read value (%IW0)
4      if $0 < $M0
5          %QX0.0 = 1;           // Digital output 1 enable
6      else
7          %QX0.0 = 0;           // Digital output 1 disable
8      endif;
9      endf                        // function end
10     endp                        // end code

```

Application temperature control is created in example-5.

The read temperature is displayed at the by element tool first.

In the second element tool, the set value is displayed by the help of the increase and decrease buttons.

The temperature value is read as non decimal of macro code at the row 2 %IW0 from the analog input address. For example, the read value is 245 for 24.5°C value .

To display this value as a decimal value, the divided value of the set the value from address% IW0 divided by 10 is assigned to address \$0 in the row second.

So, the 245 value is displayed as 24.5

The set value at \$M0 is compared with the active value at address is \$0 in the row third, and if the active value is less than the set value, % QX0.0 digital output is activate the row fourth. If The active value isn't less than disable the digital output.

The main macro period is set to 100 milliseconds from the settings of the project.

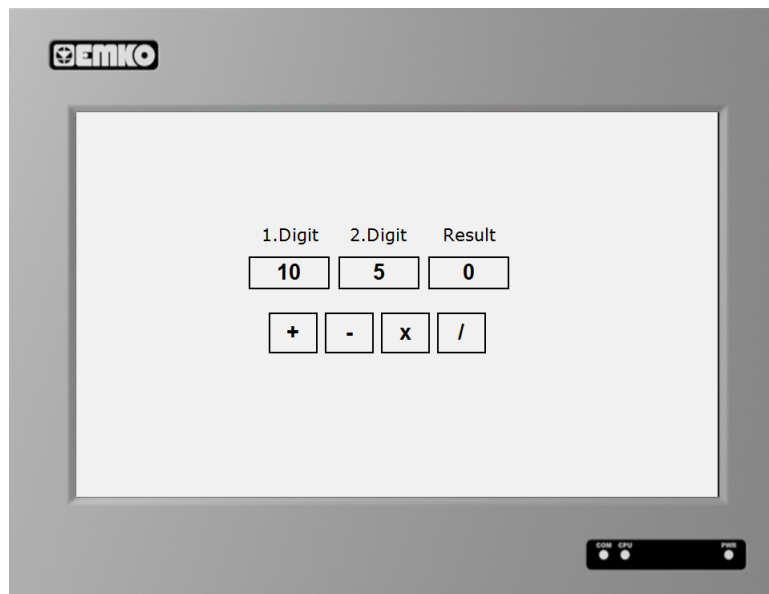
Example-6(Macro Application-2)

Picture 98: Macro Application

Four operational scenarios were created in example-6.

Value is entered with the value input element tools used for 1.digit and 2.digit.

Then the push buttons used for +, -, x, / (addition, subtraction, multiplication, division).

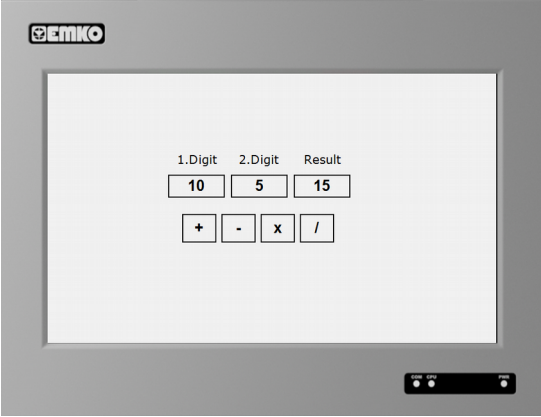
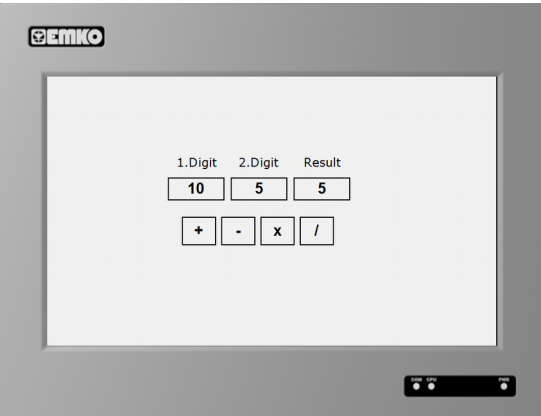
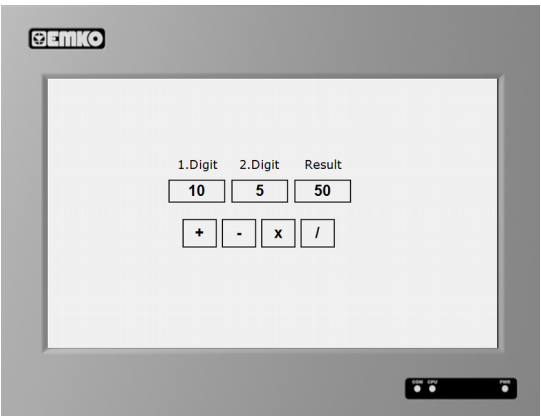

The first address is \$0, the second address is \$1, and the result address is \$3.

Used Button	Macro Code Executed	Result
For button '+' if button is clicked	<pre> 1 func main() 2 \$3 = \$0 + \$1; 3 endf 4 endp </pre>	 <p>The screenshot shows the EMKO calculator interface. At the top left is the EMKO logo. The main display area shows a table with three columns: '1.Digit', '2.Digit', and 'Result'. Below the table are four buttons: '+', '-', 'x', and '/'. The '1.Digit' field contains '10', the '2.Digit' field contains '5', and the 'Result' field contains '15'.</p>
For button '-' if button is clicked	<pre> 1 func main() 2 \$3 = \$0 - \$1; 3 endf 4 endp </pre>	 <p>The screenshot shows the EMKO calculator interface. The '1.Digit' field contains '10', the '2.Digit' field contains '5', and the 'Result' field contains '5'.</p>
For button '*' if button is clicked	<pre> 1 func main() 2 \$3 = \$0 * \$1; 3 endf 4 endp </pre>	 <p>The screenshot shows the EMKO calculator interface. The '1.Digit' field contains '10', the '2.Digit' field contains '5', and the 'Result' field contains '50'.</p>
For button '/' if button is clicked	<pre> 1 func main() 2 \$3 = \$0 / \$1; 3 endf 4 endp </pre>	

Example-7

Picture 99: Macro Application3

This application LEDs are blinking according to the bits assigned to the example. The start button is set to address \$1 and the bits of the LEDs are set and reset at 500 milliseconds. The \$1 address is reset and stopped with the Stop button.

Used Button	Macro Code Executed		Result
For button start if button is clicked	1	<code>func main()</code>	
	2	<code>\$1 = 1;</code>	
	3	<code>endf</code>	
	4	<code>endp</code>	
For button stop if button is clicked	1	<code>func main()</code>	
	2	<code>\$1 = 0;</code>	
	3	<code>endf</code>	
	4	<code>endp</code>	

Periodic macro code:

```
1    func main()
2    if $1 == 1                //If the start button is pressed
3    if $2 == 0                //To turn on the lights in order of
4        $0.0 = 0;            //Address of the led 1th the bit
5        $0.1 = 1;            //Address of the led 2th the bit
6        $2 = 1;              //Go led 2th
7    else
8        endf                  // function end
9    endp                      // end code
10   $0.0 = 1;
11   $0.1 = 0;
12   $2 = 0;
13   endif;
    sleep(500);                //Light every other 500 ms
endif;
endf
endp
```