

# Power Quality Analyser UMG 604-PRO

User manual and technical data



<b>1.</b>	<b>General</b>	<b>1</b>
1.1	Disclaimer	1
1.2	Copyright notice	1
1.3	Technical changes	1
1.4	Declaration of conformity	1
1.5	Comments on the manual	1
1.6	Meaning of symbols	1
<b>2.</b>	<b>Safety</b>	<b>3</b>
2.1	Safety information	3
2.2	Safety measures	4
2.3	Qualified staff	4
<b>3.</b>	<b>Proper use</b>	<b>5</b>
3.1	Inspection on receipt	5
3.2	Scope of delivery	6
3.3	Available accessories	6
<b>4.</b>	<b>Product description</b>	<b>7</b>
4.1	Measuring process	7
4.2	Network failure detection	7
4.3	Usage concept	7
4.4	GridVis® network analysis software	7
4.5	Features	8
4.6	Product overview	9
4.7	Installation location	10
<b>5.</b>	<b>Network systems</b>	<b>11</b>
5.1	Three-phase 4-conductor systems	12
5.2	Three-phase 3-conductor systems	12
5.3	Rated voltages	13
<b>6.</b>	<b>Installation</b>	<b>15</b>
6.1	Disconnectors	15
6.2	Supply voltage	15
6.3	Measured voltage	16
6.4	Current measurement	17
6.4.1	Ammeter	18
6.4.3	Direct measurement	18
6.4.2	Total current measurement	18
6.5	Connection variants	19
6.5.1	Voltage measurement	19
6.5.2	Current measurement	20
6.5.3	Supporting measurement, input V4	21
6.6	Temperature measurement	22

<b>7.</b>	<b>Interfaces</b>	<b>23</b>
7.1	Shielding	23
7.2	RS232	24
7.3	RS485	24
	7.3.2 Cable type	25
	7.3.1 Termination resistors	25
7.4	Bus structure	26
7.5	Profibus	27
	7.5.1 Connection of the bus wiring	27
<b>8.</b>	<b>Digital inputs and outputs</b>	<b>29</b>
8.1	Digital inputs	29
8.2	S0 pulse input	30
8.3	Digital outputs	31
<b>9.</b>	<b>Commissioning</b>	<b>33</b>
9.1	Connecting the supply voltage	33
9.2	Frequency measurement	33
9.3	Connecting the measured voltage	33
9.4	Phase sequence	33
9.5	Applying the measured current	34
9.6	Checking the power measurement	34
<b>10.</b>	<b>Operation</b>	<b>35</b>
10.1	Button functions	35
10.2	Display mode	35
10.3	Programming mode	36
10.4	Display password	36
10.5	Homepage password	36
<b>11.</b>	<b>Configuration</b>	<b>37</b>
11.1	Current transformer ratio	37
11.2	Current connection variants	37
11.3	Voltage transformer ratio	38
11.4	Voltage connection variants	38
11.5	RS232 configuration	39
11.6	RS485 configuration	39
11.7	Ethernet configuration	40
11.8	Profibus configuration	41
	11.8.1 Profiles	41
	11.8.2 Device master file	41
	11.8.3 Pre-set profiles	42
11.9	Recording configuration	45
<b>12.</b>	<b>System information</b>	<b>47</b>

12. 1	Measurement range exceeded	47
<b>13.</b>	<b>Device homepage</b>	<b>49</b>
13. 1	Measured values	50
	13. 1. 1 Short overview	50
	13. 1. 2 Detailed measured values	51
	13. 1. 3 Diagrams	52
	13. 1. 4 Events	52
	13. 1. 5 Transients	53
13. 2	Power quality	54
13. 3	Apps	55
	13. 3. 1 Push Service	55
13. 4	Information	56
	13. 4. 1 Device information	56
	13. 4. 2 Downloads	56
	13. 4. 3 Display	56
<b>14.</b>	<b>Service and maintenance</b>	<b>57</b>
14. 1	Repair and calibration	57
14. 2	Front film	57
14. 3	Disposal	57
14. 4	Service	57
14. 5	Battery	57
14. 6	Firmware update	57
<b>15.</b>	<b>Procedure in the event of faults</b>	<b>59</b>
<b>16.</b>	<b>Technical data</b>	<b>61</b>
16. 1	General	61
16. 2	Environmental conditions	61
16. 3	Transport and storage	61
16. 4	Supply voltage	62
16. 5	Protection class	62
16. 6	Digital inputs and outputs	63
16. 7	Temperature measurement input	64
16. 8	Voltage measurement inputs	65
16. 9	Current measurement inputs	65
16. 10	Interfaces	66
16. 11	Measurement uncertainty	67
<b>17.</b>	<b>Parameter list</b>	<b>69</b>
<b>18.</b>	<b>Measured value indications</b>	<b>73</b>
<b>19.</b>	<b>Dimension diagrams</b>	<b>75</b>

19. 1	Front view	75
19. 2	Side view	76
<b>20.</b>	<b>Connection example</b>	<b>77</b>
<b>21.</b>	<b>Short introduction (setting primary current)</b>	<b>79</b>

## 1. General

### 1.1 Disclaimer

Observing the information products for the devices is the prerequisite for safe operation and in order to obtain the specified performance and product features. Janitza electronics GmbH accepts no liability for injuries to personnel, property damage or financial losses arising due to a failure to comply with the information products. Ensure that your information products are accessible and legible.

### 1.2 Copyright notice

© 2017 - Janitza electronics GmbH - Lahnau. All rights reserved.

Duplication, editing, dissemination and other utilisation, also in part, is prohibited. All trademarks and the resulting rights are the property of their respective owners.

### 1.3 Technical changes

- Please ensure that your device complies with the installation manual.
- Please read and understand the documents enclosed with the product first.
- Keep the documents enclosed with the product available throughout the entire service life of the product and pass them on to subsequent users if applicable.
- Inform yourself of any new device versions and the associated updates to the documentation enclosed with the product at [www.janitza.de](http://www.janitza.de).

### 1.4 Declaration of conformity

For information on the laws, standards and directives that Janitza electronics GmbH has applied for the device, see the declaration of conformity on our website ([www.janitza.de](http://www.janitza.de)).

### 1.5 Comments on the manual

We welcome your comments. If anything in this manual seems unclear, please let us know by sending us an **e-mail** to: [info@janitza.de](mailto:info@janitza.de)

### 1.6 Meaning of symbols

This manual uses the following pictograms:



Ground wire connection.



#### **Inductive.**

The current lags behind the voltage.



#### **Capacitive.**

The voltage lags behind the current.



## 2. Safety

Please read this user manual and all other publications that must be consulted to work with this product. This applies particularly to installation, operation and maintenance.

Observe all safety instructions and warnings. Failure to comply with the instructions can result in personal injuries and/or damage to the product.

Any unauthorised changes or use of this device, which go beyond the mechanical, electrical or otherwise stated operating limitations, can result in bodily injury and/or damage to the product.

Any such unauthorised change constitutes "misuse" and/or "negligence" according to the warranty for the product and thus excludes the warranty for covering possible damage resulting from this.

The user manual:

- must be read before using the device.
- must be kept throughout the entire service life of the product and be readily available for reference.

Follow additional legal and safety regulations required for the respective application when using the device.

### 2.1 Safety information

Symbols used:



This symbol is used as an addition to the safety instructions and warns of an electrical hazard.



This symbol with the word note describes:

- Procedures that do not pose any risk of injuries.
- Important information, procedures or handling steps.

Safety information is highlighted by a warning triangle and is indicated as follows depending on the degree of danger:



**DANGER!**

Indicates an imminent danger that causes severe or fatal injuries.



**WARNING!**

Indicates a potentially hazardous situation that can cause severe injuries or death.



**CAUTION!**

Indicates a potentially hazardous situation that can cause minor injuries or damage to property.



## 2.2 Safety measures

When operating electrical devices, certain parts of these devices are invariably subjected to hazardous voltage. Therefore, severe bodily injuries or damage to property can occur if they are not handled properly:



**WARNING!**

### **Risk of injury due to electric voltage!**

Severe bodily injuries or death can occur due to dangerous voltages.

**Therefore, note the following:**

- **Before connecting connections, earth the device at the ground wire connection if present.**
- **Hazardous voltages may be present in all switching parts that are connected to the power supply.**
- **Hazardous voltages may also be present in the device even after disconnecting the supply voltage.**
- **Provide single core conductors with sleeves.**
- **Only connect screw-type terminals with a matching number of pins and of the same type.**
- **De-energise the system before starting work.**

## 2.3 Qualified staff

This device must only be operated and repaired by specialised personnel.

Specialised personnel are people who are qualified to recognise risks and prevent potential dangers that can be caused by the operation or maintenance of the device based on their respective training and experience.



**WARNING!**

If the device is not operated according to the documentation, protection is no longer ensured and hazards can be posed by the device.

### 3. Proper use

#### 3.1 Inspection on receipt

The prerequisites of faultless, safe operation of this device are proper transport and proper storage, set-up and installation, as well as careful operation and maintenance.

Packing and unpacking must be carried out with customary care without the use of force and only using suitable tools. The devices should be visually checked for flawless mechanical condition.

Please check the delivered items for completeness before you start installing the device.

If it can be assumed that risk-free operation is no longer possible, the device must be immediately put out of operation and secured against being put back into operation again. It can be assumed that risk-free operation is no longer possible if the device, for example:

- has visible damage,
- no longer works despite the mains power supply being intact
- has been exposed to prolonged adverse conditions (e.g. storage outside the permissible climate limits without being adapted to the room climate, condensation, etc.) or rough handling during transportation (e.g. falling from a height, even if there is no visible external damage, etc.)

**NOTE!**

The user manual also describes options that are not supplied as standard.

### 3.2 Scope of delivery

Number	Part no.	Designation
1	52.16.xxx <sup>1)</sup>	UMG 604-PRO
1	33.03.338	Installation manual
1	33.03.352	“GridVis software” quick guide
1	10.01.807	Screw-type terminal, pluggable, 2-pin
1	10.01.808	Screw-type terminal, pluggable, 3-pin
1	10.01.809	Screw-type terminal, pluggable, 5-pin
1	10.01.810	Screw-type terminal, pluggable, 6
1	89.10.051	Slotted screwdriver (0.40 x 2 mm), ESD
1	08.01.505	2m patch cable, twisted, grey (UMG PC/switch connection)
1	52.00.008	RS485 termination resistor, 120 ohms

<sup>1)</sup> For the item number, see the delivery note

### 3.3 Available accessories

Part no.	Designation
21.01.058	CR2032 lithium battery, 3 V (approval according to UL 1642)
08.02.427	RS232, connection cable (UMG604-PRO - PC), 2 m, 5-pin



**NOTE!**

All screw-type terminals included in the scope of delivery are attached to the device.



**NOTE!**

All supplied options and versions are described on the delivery note.

## 4. Product description

The device is intended for:

- measuring and calculating electrical variables such as voltage, current, power, energy, harmonics, in building installations, on distribution units, circuit breakers and busbar trunking systems.
- measuring measured voltages and currents that derive from the same network.
- measurements in low voltage networks where rated voltages of up to 300 V phase to earth and surge voltages of overvoltage category III can occur.
- installation in fixed switching cabinets or small installation distributors. It can therefore be installed in any position.
- measurements in medium and high-voltage networks with current and voltage transformers.
- current measurement via external ..1 A or ../5 A current transformers.

The measurement results can be displayed, read out and further processed via the device's interfaces.

The device meets the test requirements for use in industrial areas.

### 4.1 Measuring process

The device measures continuously and calculates all effective values over a 200 ms interval.

### 4.2 Network failure detection

Network failure detection is carried out via the voltage measurement inputs. The selection of voltage measurement inputs can be configured using the GridVis® software.

The device bridges the following network failures on the auxiliary voltage input:

- Supply voltage: 230 V AC
- Bridging time: max. 80 ms

### 4.3 Usage concept

You can program and call up the measured values via many routes using the device:

- **Directly** on the device via 2 buttons and the display.
- Using the **GridVis®** programming software.
- Using the **device homepage**.
- Using the **Modbus protocol**. You can modify and call up the data using the Modbus address list. The list can be called up from **www.janitza.de**.

This operation manual only describes how to operate the device using the 2 buttons. The GridVis® programming software has its own "online help" system.



#### NOTE!

Use the parameter list from "17. Parameter list" for configuration on the device and use the Modbus address list on [www.janitza.de](http://www.janitza.de) for configuration via a serial interface

### 4.4 GridVis® network analysis software

You can use the GridVis® network analysis software that is available at [www.janitza.de](http://www.janitza.de) to program the device and read out data. To do this, a PC must be connected to the device via a serial interface (RS485/Ethernet).

You can use the GridVis® network analysis software to:

- program the device.
- configure and read out recordings.
- save the data to a database.
- display measured values graphically.
- program customer-specific applications.

## 4.5 Features

### General

- Installation on a 35 mm DIN rail
- LCD display, backlight (optional)
- Operation via 2 buttons
- 4 voltage and 4 current measurement inputs
- 1 temperature measurement input
- 2 digital outputs and 2 digital inputs
- RS485 interface (Modbus RTU, Modbus master)
- RS232 interface
- Profibus DP / V0 (optional)
- Ethernet (web server, e-mail)
- Suitable for installation in installation distributors
- Suitable for measurements in networks with frequency converters
- Working temperature range -10 °C to +55 °C

### Measurement

- Measurement in IT, TN and TT networks
- Continuous sampling of the voltage and current measurement inputs
- Logging and storing transients > 50 µs
- Capture more than 800 measured values
- Fourier analysis 1st to 40th Harmonics for U, I, P (consumption/delivery), Q (ind./capacitive)
- Temperature measurement
- Working measurement, measurement uncertainty:
  - Class 0.5 for ..1/5 A converter
  - Class 1 for ..1 A converter
- Programming separate applications in Jasic



### NOTE!

Measurements in medium and high-voltage networks are always performed via current and voltage transformers. Special safety requirements must be adhered to for these, which will not be described in detail here.

4.6 Product overview

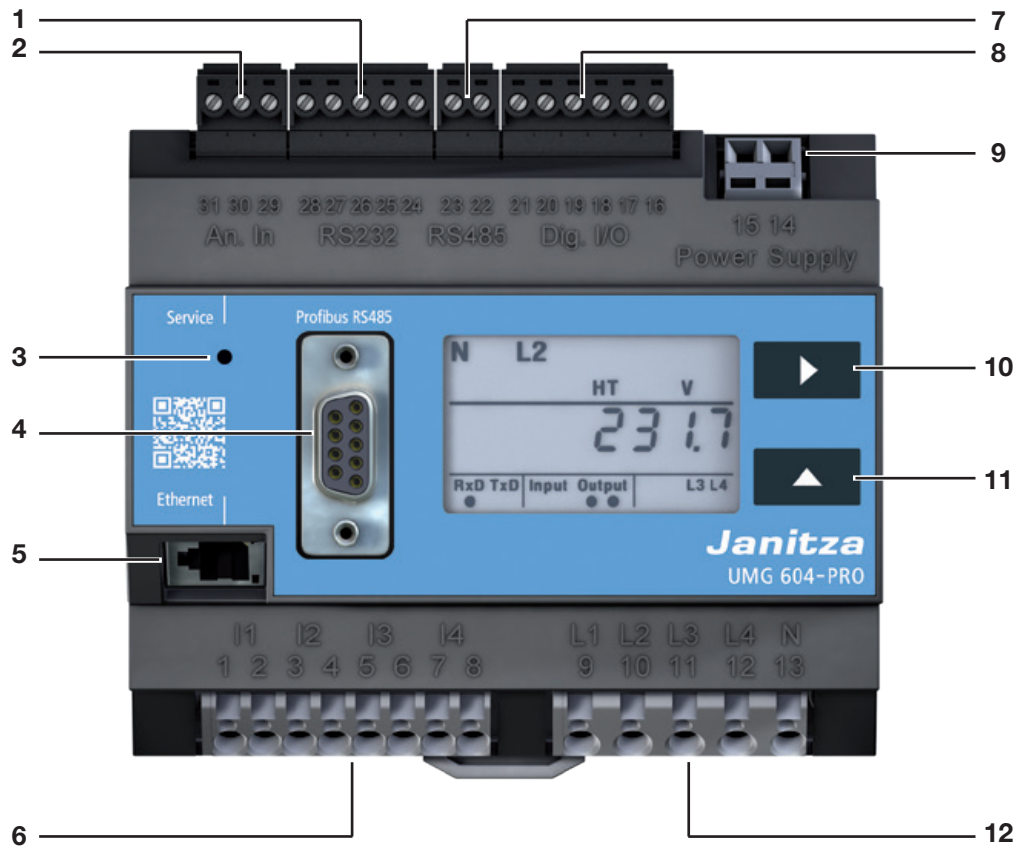


Fig. Front view of UMG604-PRO

- 1 RS232 interface
- 2 Temperature measurement input
- 3 Hidden service button
- 4 Profibus interface (optional)
- 5 Ethernet interface
- 6 Current measurement inputs I1 to I4
- 7 RS485 interface
- 8 Digital inputs / outputs
- 9 Supply voltage
- 10 Button 1
- 11 Button 2
- 12 Voltage measurement inputs L1 to L4

#### 4.7 Installation location

The device can be installed in switching cabinets or in small installation distributors in accordance with DIN 43880

It is assembled on a 35 mm mounting rail in accordance with DIN EN 60715. It can be installed in any position.

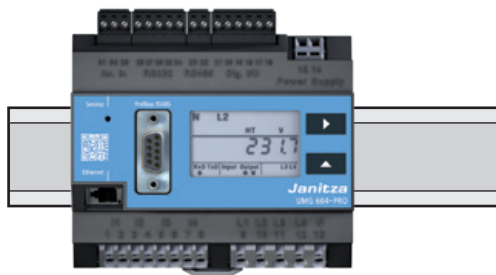


Fig. Front view of UMG 604-PRO on mounting rail

## 5. Network systems

Suitable network systems and maximum rated voltages (DIN EN 61010-1/A1):

<p><b>Three-phase four-conductor systems with earthed neutral conductor</b></p> <p><math>U_{L-N} / U_{L-L}</math> 277 VLN / 480 VLL</p>	<p><b>Three-phase four-conductor systems with non-earthed neutral conductor (IT networks)</b></p> <p><math>U_{L-N} / U_{L-L}</math> 277 VLN / 480 VLL</p>	<p><b>Three-phase three-conductor systems not earthed</b></p> <p><math>U_{L-L}</math> 480 VLL</p>	<p><b>Three-phase three-conductor systems with earthed phase</b></p> <p><math>U_{L-L}</math> 480 VLL</p>
---	---	---	--

<p><b>Dual-phase two-conductor systems not earthed</b></p> <p><math>U_{L-L}</math> 480 VLL</p>	<p><b>Single-phase two-conductor systems with earthed neutral conductor</b></p> <p><math>U_{L-N}</math> 480 VLN</p>	<p><b>Separated single-phase three-conductor system with earthed neutral conductor</b></p> <p><math>U_{L-N} / U_{L-L}</math> 277 VLN / 480 VLL</p>
--	---	--

The device can be used in:

- 2-, 3- and 4-conductor networks (TN, TT and IT networks)
- domestic and industrial settings.



**WARNING!**

**Risk of injury due to electric voltage!**

If the device is subjected to measurement voltage surges higher than the permissible overvoltage category, safety-relevant insulations in the device can be damaged, which means that the product's safety can no longer be guaranteed.

**Only use the device in environments in which the permissible measurement voltage surge is not exceeded.**



**5.1 Three-phase 4-conductor systems**

The device can be used in three-phase 4-conductor systems (TN, TT networks) (50 Hz, 60 Hz) with an earthed neutral conductor. The bodies of the electrical system are earthed. The voltage between phase and neutral conductor may be a maximum of 300 V AC.

The device is only suitable for environments in which the permissible measurement voltage surge and overvoltage category are not exceeded.

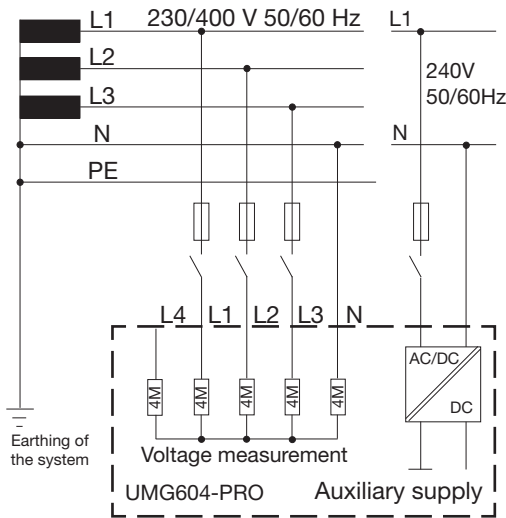


Fig. Schematic diagram, UMG 604-PRO in a TN network

**5.2 Three-phase 3-conductor systems**

The device can be used in non-earthed three-phase 3-conductor systems (IT network).

The voltage between phase and phase may be a maximum of 480 V AC (50 Hz, 60 Hz). The IT network is not earthed at the neutral point of the voltage generator. The bodies of the electrical system are earthed. Earthing via a high ohm impedance is permitted.

IT networks are only permitted in certain systems with their own transformers or generators.

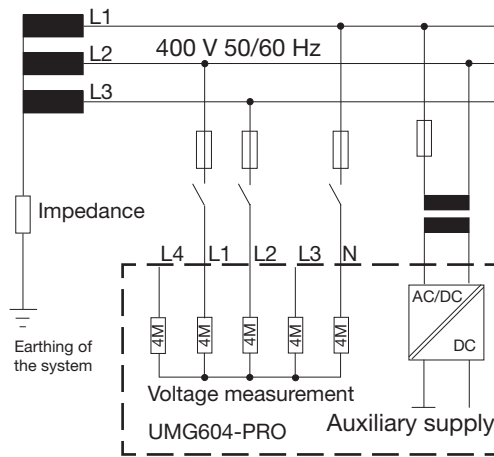


Fig. Schematic diagram, UMG 604-PRO in an IT network without N.

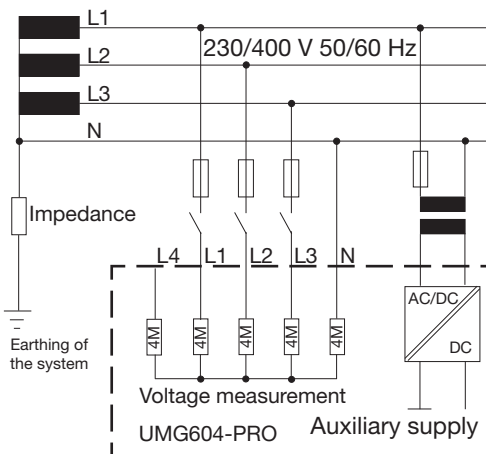


Fig. Schematic diagram, UMG 604-PRO in an IT network with N

### 5.3 Rated voltages

The following illustrations show lists of networks and the corresponding rated network voltages in which the device can be used.

$U_{L-N} / U_{L-L}$
66 V / 115 V
120 V / 208 V
127 V / 220 V
220 V / 380 V
230 V / 400 V
240 V / 415 V
260 V / 440 V
277 V / 480 V

Fig. Table of suitable rated voltages in a three-phase 4-conductor network

$U_{L-L}$
66V
115V
120V
127V
200V
230V
240V
260V
277V
347V
380V
400V
415V
440V
480V

Fig. Table of suitable rated voltages in a three-phase 3-conductor network



## 6. Installation

### 6.1 Disconnectors

During building installation, provide a suitable disconnecter in order to disconnect the device from the current and voltage.


- Install the disconnecter close to the device so that it is easily accessible to the user.
- Label the switch as a disconnection device.

### 6.2 Supply voltage

The device requires supply voltage to operate.

Before connecting the supply voltage, ensure that the voltage and frequency correspond to the details on the rating plate!

The connection lines for the supply voltage must be protected using a UL-listed fuse or a circuit breaker.




**CAUTION!**

**Damage to property due to not observing the connection conditions**

Failure to observe the connection conditions can damage or destroy your device.  
**Therefore, note the following:**

- Adhere to the specifications for voltage and frequency on the rating plate.
- Connect the supply voltage via a fuse in accordance with the technical data.
- Do not connect the supply voltage to the voltage transformers.



**WARNING!**

**Risk of injury due to electric voltage!**

Severe bodily injuries or death can occur due to

- touching bare or stripped wires that are live,
- device inputs that are dangerous to touch.

**Therefore, note the following:**

- De-energise your system before starting the work!
- The inputs for the supply voltage are hazardous if touched!

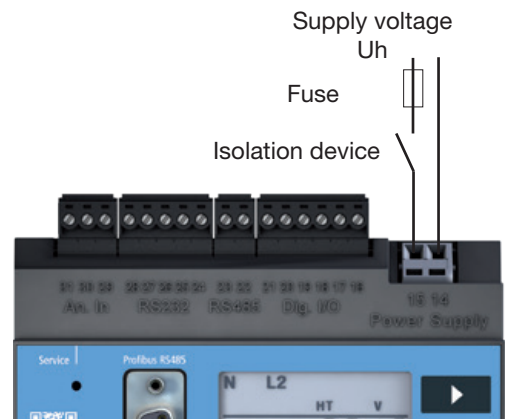




Fig.23.1 Example connection for the supply voltage  $U_h$ .

 **NOTE!** Provide single core conductors with sleeves.

 **NOTE!** Devices that can be operated with DC voltage are protected against polarity reversal.

### 6.3 Measured voltage

The device is designed to measure AC voltage in 300 V networks, in which overvoltages of category III can occur.

The device can only determine measured values if measured voltage of  $>10 V_{eff}$  is present on at least one voltage measurement input.

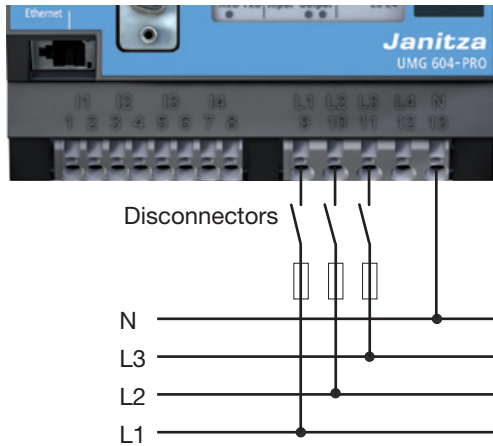


Fig.23.1 Connection example: Voltage measurement via short circuit-proof measurement wires

Note the following when selecting the measurement wires:

- Use measurement wires that are suitable for 300 V to earth and 520 V conductor to conductor.
- Fuse the normal measurement wires using an overcurrent protection device.
- Route normal short circuit-proof measurement wires via a disconnector.
- Connect the voltages higher than 300 V to earth using voltage transformers.

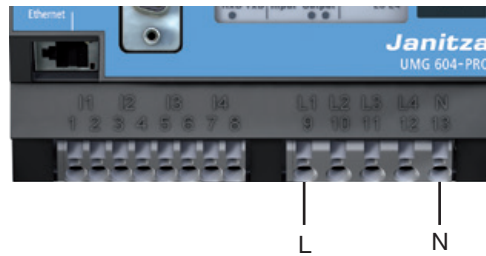


Fig. Voltage measurement input with connected phase L and neutral conductor N



#### CAUTION!

#### Malfunction due to incorrect connection

If the device is connected incorrectly, incorrect measured values may be returned.

**Therefore, note the following:**

- **Measured voltages and currents must derive from the same network.**
- **The device is not suitable for measuring DC voltage.**



#### WARNING!

#### Risk of injury due to electric voltage!

Severe bodily injuries or death can occur due to a failure to observe the connection conditions for the voltage measurement inputs.

**Therefore, note the following:**

- **Do not use the device for voltage measurement in SELV circuits.**
- **Connect voltages that exceed the permissible network rated voltages via a voltage transformer.**
- **The voltage measurement inputs on the device are dangerous if touched!**
- **Install a disconnector as described in “6. 1 Disconnectors”.**

### 6.4 Current measurement

The device:

- is intended for connecting current transformers with secondary currents of ..1 A and ..5 A.
- does not measure DC.
- has current measurement inputs that can be continuously loaded with 6 A or loaded with 100 A for 1 second.

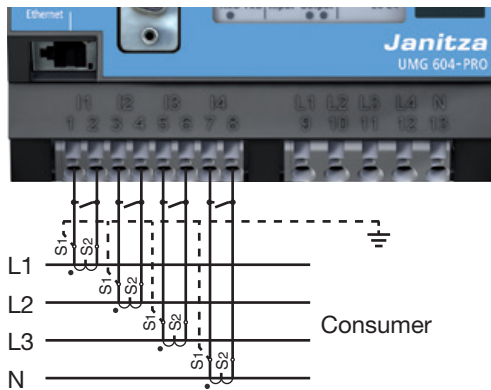


Fig. Current measurement via current transformers connection example.



**NOTE!**

It is not necessary to configure a connection schematic for measurement inputs L4 and I4.



**WARNING!**

**Risk of injury due to electric voltage on current transformers!**

On current transformers that are operated open on the secondary side, high voltage peaks that are dangerous to touch can occur, which can cause severe bodily injuries or death.

Therefore, note the following:

- **Avoid operating the current transformers open.**
- **Short circuit all unloaded current transformers.**
- **Connect the earthing connections provided on the current transformer to the earth.**
- **You must short circuit the secondary connections on the current transformer before interrupting the power supply.**
- **If a test switch, which automatically short-circuits the secondary wires of the current transformer is available, it is sufficient to set this to the "Test" position as long as the short-circuiting device has been checked beforehand.**
- **Ensure that the attached screw-type terminal is affixed to the device sufficiently using the two screws.**
- **Safe open-circuit current transformers are also dangerous to touch when they are operated open.**



**WARNING!**

**Risk of injury due to electric voltage!**

**Current measurement inputs are dangerous to touch.**

### 6.4.1 Ammeter

If you wish to measure the current not only with the UMG but rather with an ammeter too, connect the ammeter to the UMG in series.

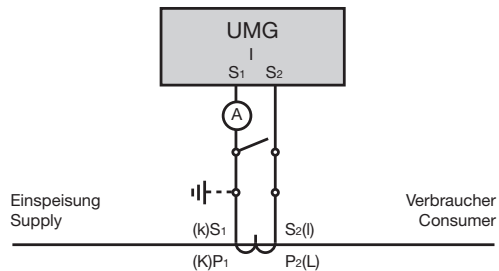


Fig. Circuit diagram with additional ammeter switched in series

### 6.4.3 Direct measurement

Rated currents of up to 5 A can be measured directly on the device. When doing so, note that each current measurement input can be continuously loaded with 6 A or loaded with max. 100 A for 1 second.

The device does not have integrated protection for current measurement. Therefore, provide a 6 A line protection fuse or automatic circuit breaker as protection against overcurrent when installing.

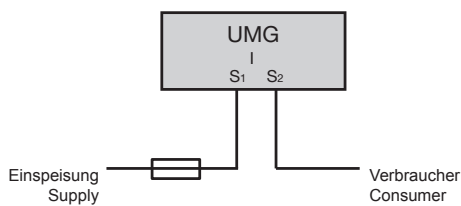


Fig. Example of direct current measurement.

### 6.4.2 Total current measurement

For a summation measurement via two current transformers, first set their total transformation ratio on the device. For information on setting the current transformer ratios, see "11.1 Current transformer ratio".

#### Example:

The current is measured via two current transformers. Both current transformers have a transformation ratio of 1000 / 5 A. The summation measurement is performed using a 5+5 / 5 A total current transformer.

The device must then be set up as follows:

Primary current: 1000 A + 1000 A = 2000 A  
Secondary current: 5 A

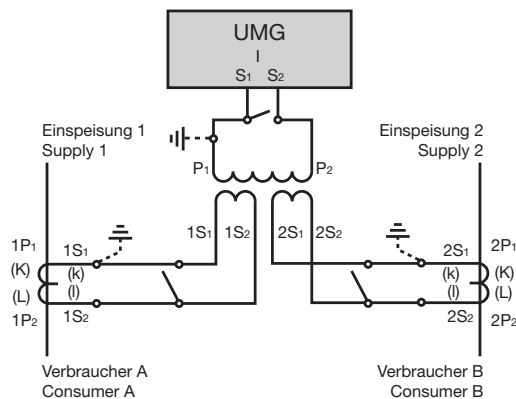
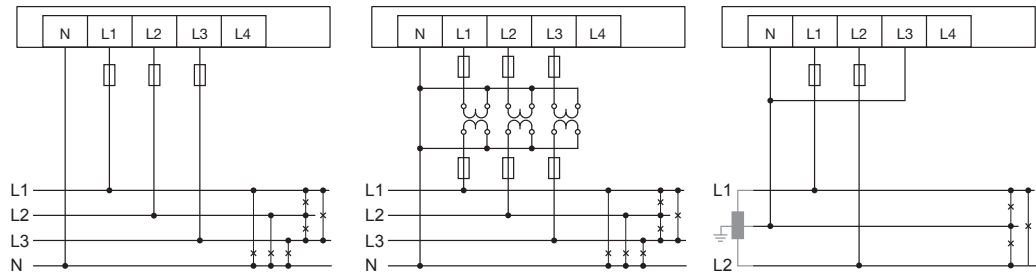
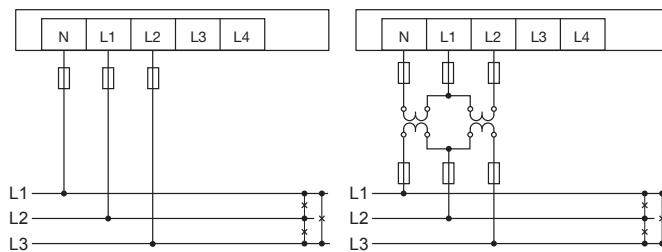


Fig. Example for current measurement via a total current transformer

**6.5 Connection variants**  
**6.5.1 Voltage measurement**



*Fig. Connection examples for voltage measurement in "Three-phase 4-conductor networks" and "Single-phase 3-conductor networks".*



*Fig. Connection examples for voltage measurement in "Three-phase 3-conductor networks".*



### 6.5.2 Current measurement

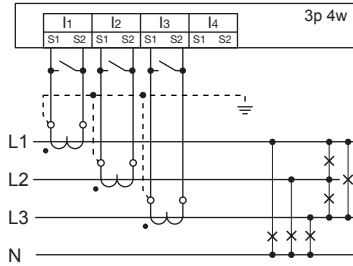


Fig. Current measurement, connection example for connection variant 0.

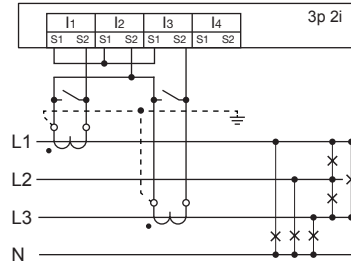


Fig. Current measurement, connection example for connection variant 0.

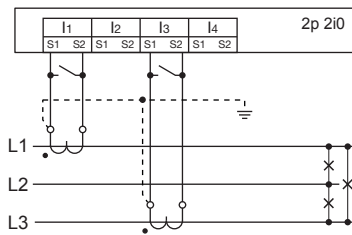


Fig. Current measurement, connection example for connection variant 1.

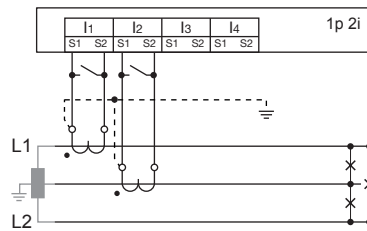


Fig. Current measurement in the single-phase 3-conductor system. Connection variant 0.

6.5.3 Supporting measurement, input V4

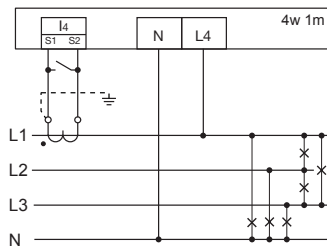


Fig. Measurement in a three-phase 4-conductor network with symmetric loading.

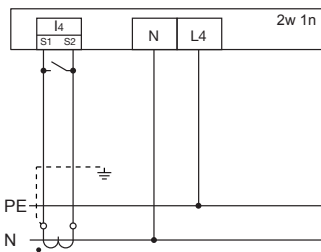


Fig. Measurement of the voltage between N and PE. Measurement of the current in the neutral conductor.

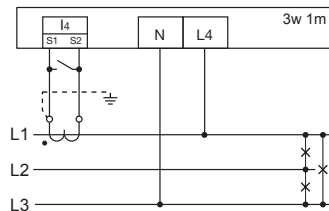


Fig. Measurement in a three-phase 3-conductor network with symmetric loading.

**NOTE!**  
If the baseline measurement (inputs V1-V3) is connected to a three-phase 3-conductor network, the supporting measurement (input V4) can no longer be used as a measurement input.

**NOTE!**  
For measurement with the supporting measurement (V4), a voltage must be connected to the baseline measurement for frequency determination.

**NOTE!**  
Measured voltages and measured currents must derive from the same network.

## 6.6 Temperature measurement

The device has a temperature measurement input that is designed for a maximum total burden of 4 kOhm. The total burden refers to sensors and the line.

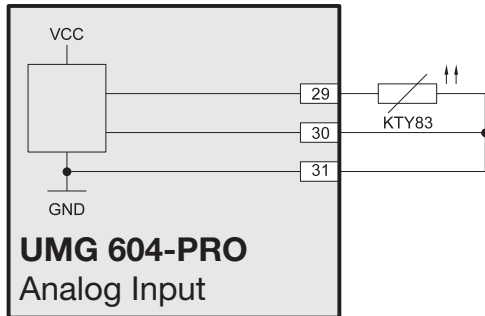


Fig.42.1 Example, temperature measurement with a KTY83.

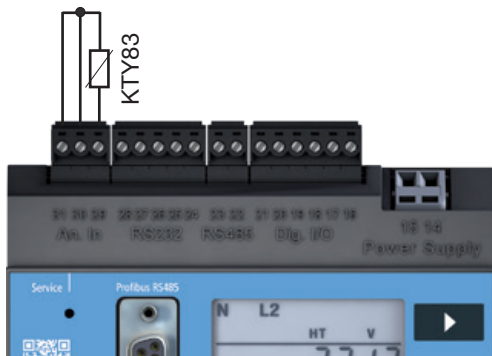


Fig. Connecting temperature sensor to the measurement input



**CAUTION!**

**Transmission errors and damage to property due to electrical faults**

If the line is longer than 30 m, there is an increased probability of transmission errors and damage to the device due to atmospheric discharge.

**Use a shielded cable to connect to the temperature sensor.**



**CAUTION!**

**Risk of injury due to electric voltage!**

Insufficient insulation of the operating equipment at the temperature measurement input to the mains supply circuits can cause the temperature measurement input and interfaces RS232 and RS485 to convey hazardous voltage.

**Ensure that there is reinforced or double insulation to the mains supply circuits!**



**WARNING!**

**Risk of injury due to electric voltage!**

RS232, RS485 and the temperature measurement input are not galvanically separated from each other.

**Therefore, be aware that hazardous voltages on the inputs that are not galvanically separated may have effects on the other connections.**

## 7. Interfaces

The device has the following interfaces:

- RS232
- RS485
- Ethernet
- Profibus (optional)

All interfaces can be used simultaneously.

### 7.1 Shielding

A twisted, shielded cable should be used for connections via the RS232 and RS485 interfaces.

Earth the shields of all cables that lead to the cabinet and at the cabinet entry.

Connect the screens over a generous area and in a manner that will conduct well, to a low-noise earth.

Gather the cables mechanically above the earthing clamp in order to avoid damage due to cable movements.

Use suitable cable glands to feed the cables into the cabinet, for example, armoured conduit couplings.

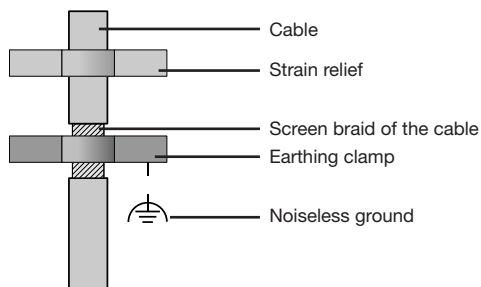


Fig. Shielding procedure at cabinet entry.



**WARNING!**

**Risk of injury due to electric voltage!**

RS232, RS485 and the temperature measurement input are not galvanically separated from each other. The Profibus and Ethernet are functionally insulated from each other and the remaining interfaces.

**Therefore, be aware that hazardous voltages on the inputs that are not galvanically separated may have effects on the other connections.**

### 7.2 RS232

You can use an RS232 connection cable to connect the device to a PC.

The achievable distance between two devices with RS232 interfaces depends on the cable used and the baud rate.

The maximum cable length that can be connected is 30 m!

As a guideline, if the transmission rate is 9600 Baud, a distance of 15 m to 30 m should not be exceeded.

The permissible ohmic load must be greater than 3 kOhm and the capacitive load caused by the transmission line must be lower than 2500 pF.

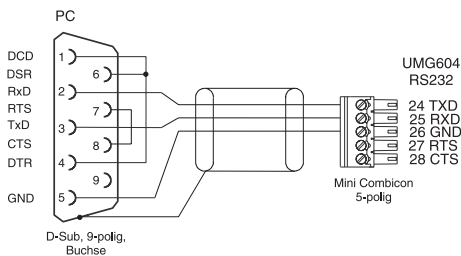


Fig. Plug arrangement for the PC connection cables (item no. 08 02 427).

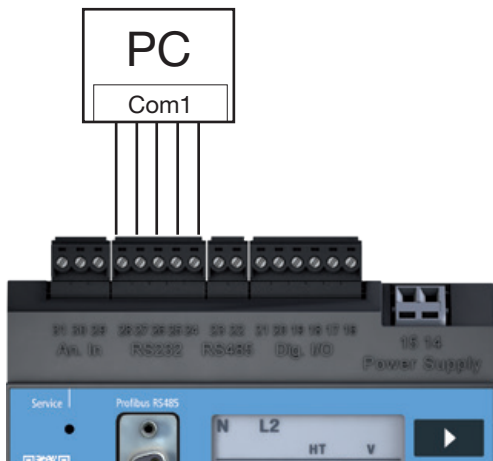


Fig. Example, connecting a UMG604-PRO to a PC via the RS232 interface.

### 7.3 RS485

The RS485 interface is designed as a 2-pin plug contact in the UMG 604.

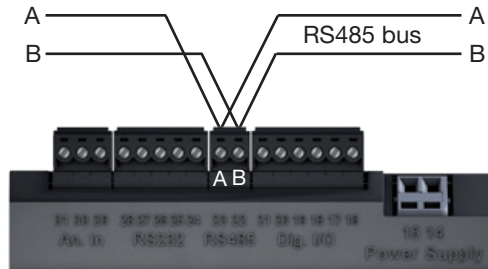


Fig. RS485 interface, 2 pin plug contact

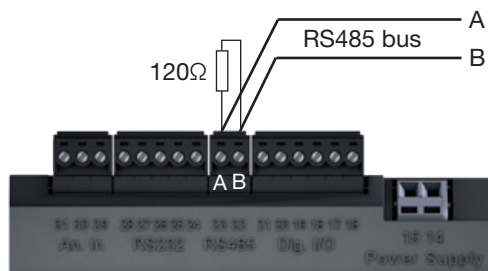


Fig. RS485 interface, 2-pin plug contact with termination resistor (item no. 52.00.008).

### 7.3.2 Cable type

CAT cables are not suitable for bus wiring. Instead, we recommend the following cable type:

- Unitronic Li2YCY(TP) 2x2x0.22 (from Lapp Kabel)

The maximum cable length is 1200 m at a baud rate of 38.4 k.



**WARNING!**

**Risk of injury due to electric voltage!**

Temperatures of up to 80 °C can occur on the connections if there are high measured currents.

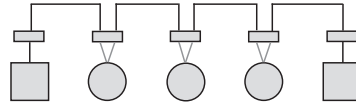
**Therefore, use lines that are designed for an operating temperature of at least 80 °C**

### 7.3.1 Termination resistors

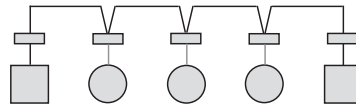
The cable is terminated with resistors (120 Ohm 1/4 W) at the beginning and at the end of a segment.




The UMG604-PRO does not contain any termination resistors.

#### Correct



#### Incorrect



-  Terminal strip in the cabinet.
-  Device with RS485 interface. (without termination resistor)
-  Device with RS485 interface. (with termination resistor on the device)

#### 7.4 Bus structure

- All devices are connected in a bus structure (line).
- Up to 32 participants can be connected together in a single segment.
- The cable is terminated with resistors at the beginning and at the end of a segment.
- If there are more than 32 participants, repeaters (amplifiers) must be used to connect the individual segments.
- Devices for which the bus connection is switched on must be under current.
- It is recommended that the master be placed at the end of a segment.
- If the master is replaced with a bus connection, the bus must be switched off.
- Replacing a slave with a bus connection that is either switched off or de-energised can destabilise the bus.
- Devices that are not connected to the bus can be replaced without destabilising the bus.

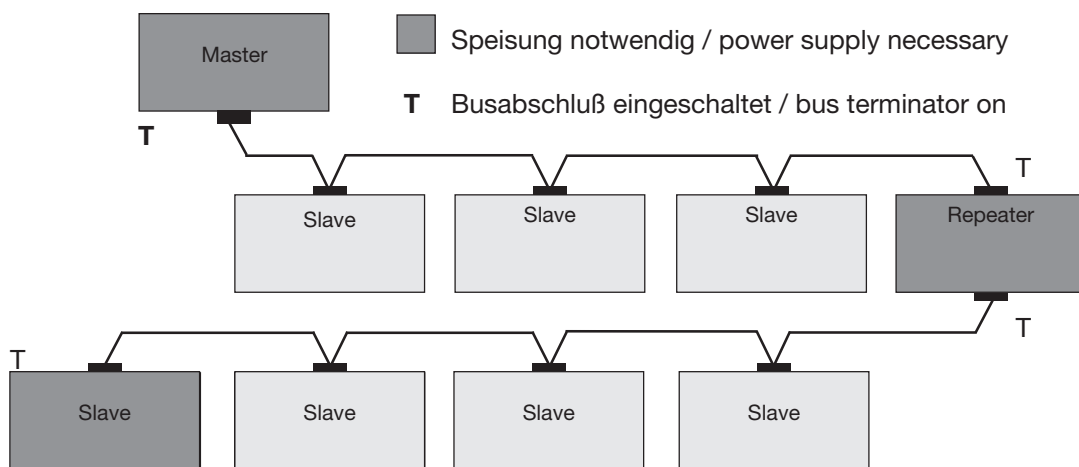


Fig. Bus structure illustration

### 7.5 Profibus

The UMG 604-PRO is optionally equipped with a Profibus connection that is designed as a 9-pin DSUB receptacle.

For the connection, we recommend a "SUBCON-Plus-ProfIB/AX/SC" 9-pin Profibus connector from Phoenix.

You can order this from us using Janitza item number 13.10.539.

#### 7.5.1 Connection of the bus wiring

The inbound bus wiring is connected to terminals 1A and 1B.

The bus wiring for the next device in line is connected to terminals 2A and 2B.

If there are no subsequent devices in the line, the bus wiring must be terminated with a resistor (switch to ON). With the switch set to ON, terminals 2A and 2B are switched off for further continuing bus wiring.

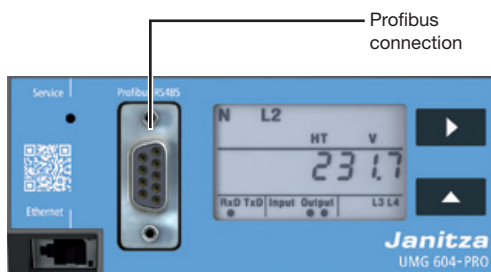


Fig.36.1 UMG 604-PRO with Profibus interface.

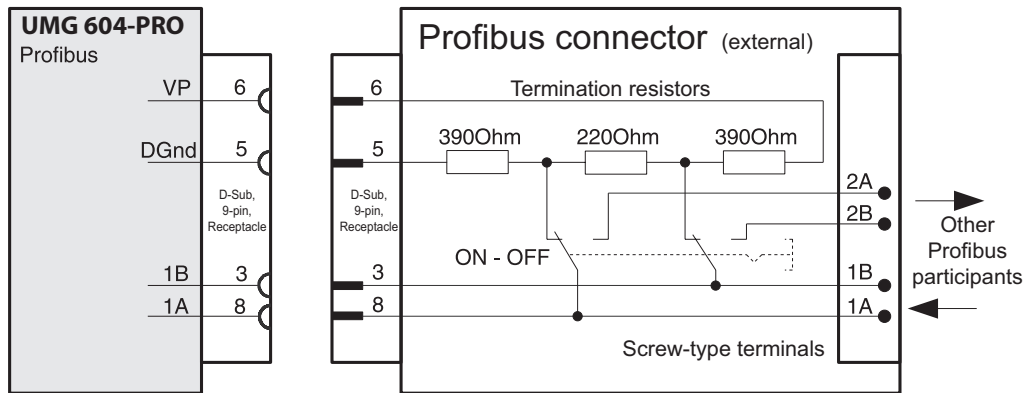


Fig. 36.1 Profibus connector with termination resistors.





## 8. Digital inputs and outputs


### 8.1 Digital inputs

The device has 2 digital inputs to which you can connect one signal generator each.

An input signal is detected on a digital input if a voltage of at least 10 V and maximum 28 V DC is applied.


The flowing current is at least 1 mA and a maximum of 6 mA.

Pay attention to the supply voltage's polarity!



**CAUTION!** **Transmission errors and damage to property due to electrical faults**

If the line is longer than 30 m, there is an increased probability of transmission errors and damage to the device due to atmospheric discharge.  
**Use a shielded cable for connection to the digital inputs.**



**CAUTION!** **Damage to property due to connection errors**

Ensure that the supply voltage:

- is DC voltage.
- has the right polarity.
- is not above the maximum permissible voltage.

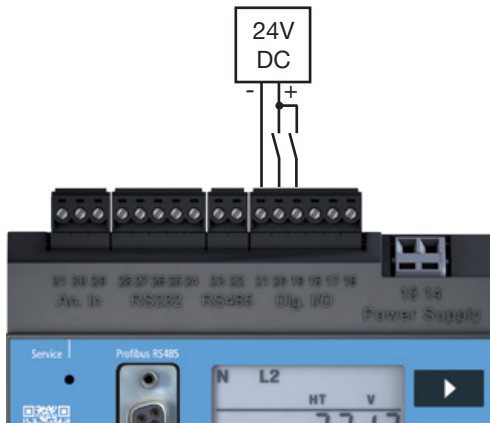


Fig. Connection example of digital inputs.

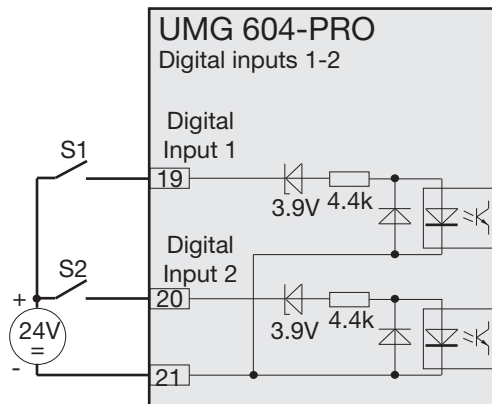


Fig. Example for the connection of external switch contacts S1 and S2 to digital inputs 1 and 2.

## 8.2 S0 pulse input

You can also connect S0 pulse transducers per DIN EN62053-31 to each UMG 604-PRO with inputs for 24 V.

To do this, you require an external auxiliary voltage of 20 to 28V DC and an external 1.5 kOhm resistor each.

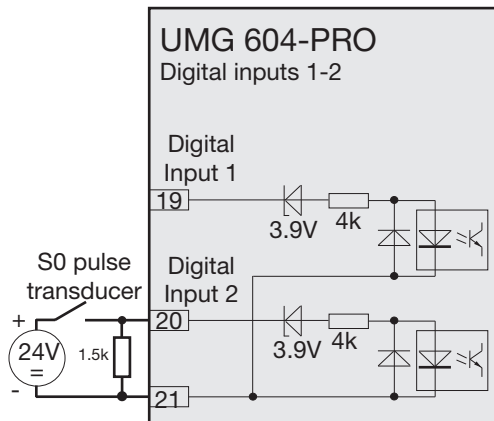


Fig. UMG 604-PRO with inputs for 24V and an S0 pulse transducer on digital input 2.

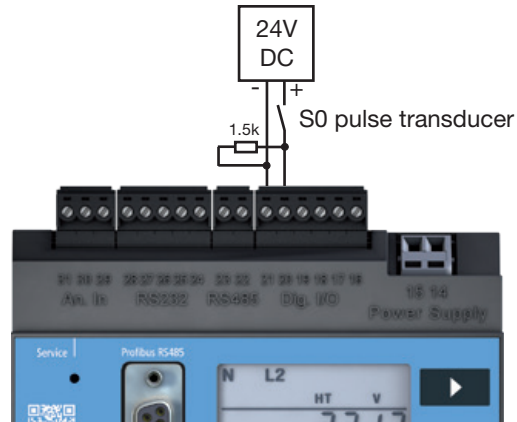


Fig. UMG 604-PRO with inputs for 24V. Example with S0 pulse transducer.

### 8.3 Digital outputs

The device has 2 transistor switching outputs that are galvanically separated from the analysis electronics using opto couplers.

The digital outputs:

- can switch DC or AC loads.
- can switch loads depending on the supply voltage's polarity.

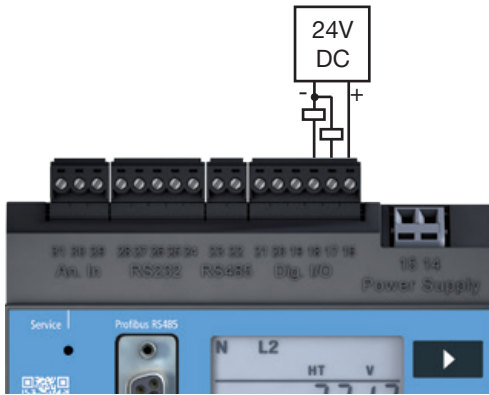





Fig. Connection example of digital outputs.

**CAUTION!**  **Transmission errors and damage to property due to electrical faults**

If the line is longer than 30 m, there is an increased probability of transmission errors and damage to the device due to atmospheric discharge.  
**Use a shielded cable for connection to the digital outputs.**

**CAUTION!**  **Measurement errors when using as a pulse output**

When using the digital outputs as pulse outputs, measurement errors may arise due to the residual ripple.  
**Therefore, use a mains adapter for the supply voltage for the digital inputs and outputs, which has a residual ripple of less than 5% of the supply voltage.**

**CAUTION!**  **Damage to property due to connection errors**

The digital outputs are not short-circuit proof! Connection errors can therefore cause damage to the connections.  
**Ensure that the wiring is correct when connecting the outputs.**

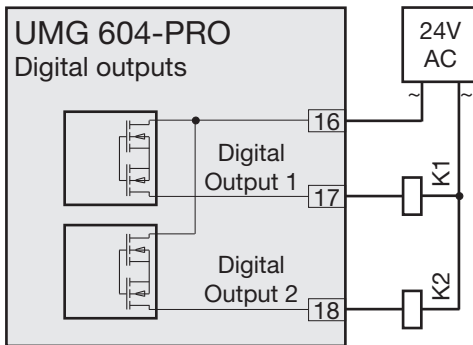


Fig. Connection of an AC voltage relay to the digital outputs.

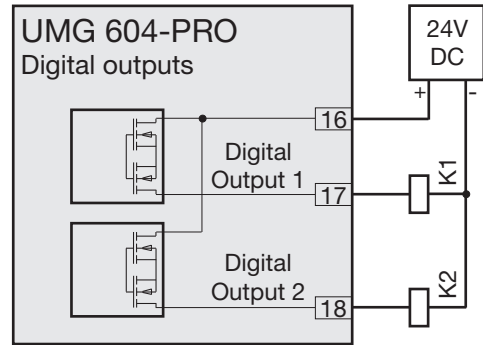


Fig. Connection of a DC voltage relay to the digital outputs.



## 9. Commissioning

Before commissioning, clear any content that may be present on the power meters, min./max. values or recordings due to the production process.

### 9.1 Connecting the supply voltage

After connecting the supply voltage, the text “Start up” is shown on the display. Approximately two to six seconds later, the device switches to the first measured value indication.

If no display appears, check whether the power supply voltage is within the rated voltage range.

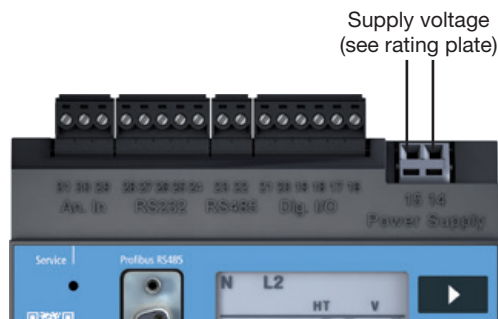


Fig.23.1 Example connection for the supply voltage  $U_h$ .

### 9.2 Frequency measurement

In order to measure the frequency, at least one voltage measurement path (L-N) must have a measured voltage of greater than 10 V. Only detected frequencies in the range of 45 Hz to 65 Hz are used for measurement on the current and voltage measurement inputs.

### 9.3 Connecting the measured voltage

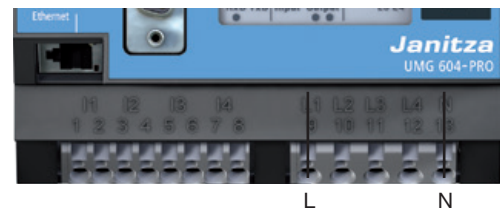
The device is suitable for measuring voltages of up to 300VAC to earth and 520 V AC phase to phase.

The device is not suitable for measuring DC voltage. Voltages over 300 V AC to earth must be connected via voltage transformers.

After connecting the measured voltages, the measured values displayed by the device for the L-N and L-L voltages must correspond to those on the voltage measurement input.

If a voltage transformer factor is programmed, it must be taken into consideration for the comparison. At least one phase (L) and the neutral conductor (N) must be connected to the voltage measurement input for measurement.

A measured voltage of greater than 10 V<sub>eff</sub> must be present on at least one of the voltage measurement inputs so that the device can determine the mains frequency.



### 9.4 Phase sequence

Check the direction of the rotating field voltage in the measured value indication of the device. A “right-hand” rotation field usually exists.

### 9.5 Applying the measured current

The device:

- is intended for connecting current transformers with secondary currents of  $\dots/1$  A and  $\dots/5$  A.
- does not measure DC.
- has current measurement inputs that are continuously loaded with 6 A or loaded with 100 A for 1 second.

Proceed as follows to connect measured current to the device:

1. Connect the currents to be measured to voltage measurement inputs I1 to I4.
  2. Short circuit all current transformer outputs except for one.
  3. Compare the currents displayed by the device with the applied current.
- Bearing in mind the current transformer conversion ratio, the current displayed by the device must correspond to the current input.
  - The device must display approx. zero amperes in the short circuited current measurement inputs.

The current transformer ratio is factory-set to 5/5A and must be adapted to the current transformer used if necessary.

### 9.6 Checking the power measurement

Short-circuit all current transformer outputs except for one and check the displayed power outputs.

The device may only display one power output in the phase with a non-short-circuited current transformer input. If this is not the case, check the connection of the measured voltage and the measuring-circuit current.

If the power figure is correct but the power sign is negative, connections S1(k) and S2(l) on the current transformer may be mixed up or they are supplying active energy back to the network.

## 10. Operation

In order to make it easier to install and commission the device without a PC, it has a display, as well as buttons 1, 2 and Service.

Important parameters such as the current transformer and the device address are listed in the parameter list in section “17. Parameter list” and can be programmed directly on the device.

Two modes are differentiated between when operating

- Display mode
- Programming mode

### 10.1 Button functions

Press the button for a short time:

- scroll forwards
- digit/value +1

Press the button for a long time:

- scroll backwards
- digit/value -1

Press and hold both buttons simultaneously for around 1 second:

- Switch between display mode and programming mode.

The device is operated using buttons 1 and 2.

The service button is only for use by trained service employees.

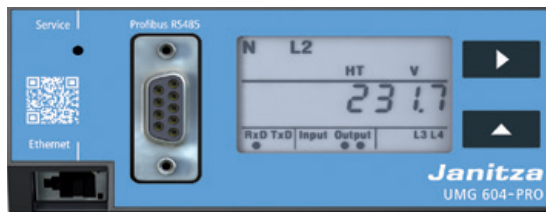


Fig. Front view of UMG 604 -PRO control element

### 10.2 Display mode

After the power returns, the device is in display mode.

In display mode, you can use buttons 1 and 2 to scroll through the measured value indications

- Use button 1 to select the phase for the measured values.
- Use button 2 to scroll between the measured values for current, voltage, power, etc.

The factory default setting for the measured value indications is shown in section “18. Measured value indications”.

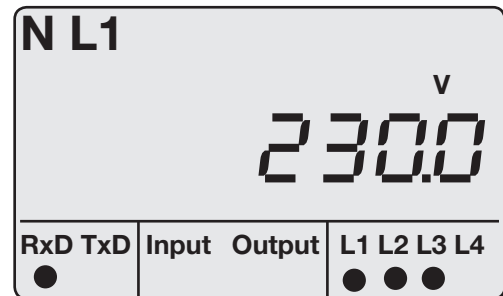


Fig. Display example for "Display mode". Measured value indication  $U_{L1-N} = 230.0 V$ .

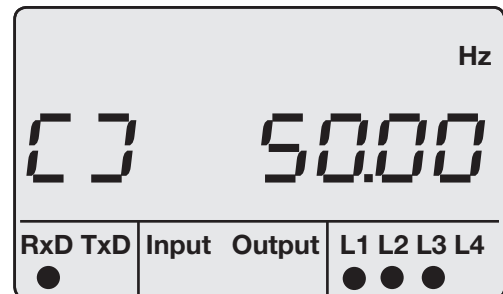


Fig. Display example for rotation field and frequency.

#### NOTE!

You can reconfigure the functions of the buttons and the selection of the values to be displayed using the GridVis® software as a Jasic program. (see [www.janitza.de](http://www.janitza.de))



### 10.3 Programming mode

You view and change the most important settings required to operate the device in programming mode.

The addresses for the most important settings are provided in section "17. Parameter list".

You can make further settings in the GridVis® software supplied.

Pressing buttons 1 and 2 simultaneously for approx. one second takes you to programming mode after the password prompt.

If a display password has not been configured, you access the programming menu directly.

Programming mode is indicated on screen by the text "PRG". The digit in the address flashes. If the device is in programming mode and no button is pressed around 60 seconds or if buttons 1 and 2 are pressed simultaneously for around one second, the device returns to display mode.

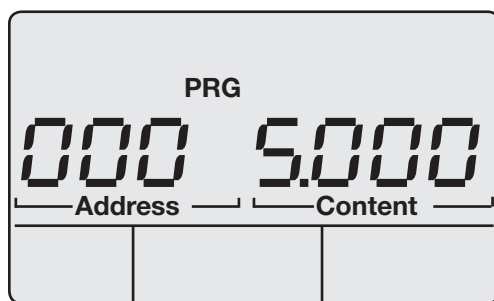


Fig. Display example for "Programming mode", address 000 with a content of 5,000.

### 10.4 Display password

To make it harder to accidentally modify the programming data on the device, you can program a 4-character display password. No display password is requested in the factory default setting.

### 10.5 Homepage password

You can password-protect access to the device's homepage. No homepage password is factory-set.

The device differentiates between 3 password modes for the homepage password:

- 0 = The homepage password is not requested.
- 2 = Changes to the configuration and the measured values display require the password to be entered once.
- 128 = Each change to the configuration requires the password to be entered again

#### NOTE!

If you no longer remember your password, you can only change it using the GridVis® software. (see [www.janitza.de](http://www.janitza.de))

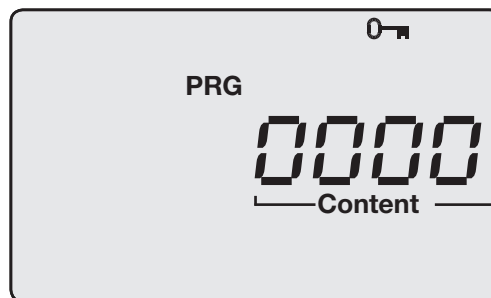


Fig. Request window for the display password

Addr.	Contents
500	Display password 0 = The password is not requested.
501	Homepage, password mode
502	Homepage password

Fig. Excerpt from the parameter list.

## 11. Configuration

This section describes how to perform configuration using the 2 buttons on the device.

### 11.1 Current transformer ratio

You can assign each of the 4 current transformer inputs its own current transformer ratio.

- A current transformer ratio of 5 A / 5 A is factory-set for all 4 current transformer inputs.
- You can program current transformers with the same current transformer ratios in addresses 000 and 001.
- You can program current transformers with different current transformer ratios in addresses 010 to 041.
- Changing the current transformer values in addresses 000 or 001 overwrites the contents of addresses 010 to 041 with the current transformer values from addresses 000 and 001.
- Changing the current transformer values in addresses 010 to 041 deletes the current transformer values in addresses 000 and 001.

Address	Current transformer values
000	L1 L2 L3 L4 (primary)
001	L1 L2 L3 L4 (secondary)
010	L1 (primary)
011	L1 (secondary)
020	L2 (primary)
021	L2 (secondary)
030	L3 (primary)
031	L3 (secondary)
040	L4 (primary)
041	L4 (secondary)

### 11.2 Current connection variants

The device recognises two connection variants for current measurement.

#### Connection variant 0

- Measurement via 3 current transformers in three phase 4-conductor networks.
- Measurement via 2 current transformers in networks with the same loading.
- Measurement in single-phase 3-conductor systems.

#### Connection variant 1

- Measurement via 2 current transformers (Aron circuit ) in three-phase 3-conductor networks.

Address	Connection variant
110	0 = three current transformers. (factory default setting)  1 = two current transformers (Aron circuit)



#### NOTE!

It is not necessary to configure a connection schematic for measurement input 4.

### 11.3 Voltage transformer ratio

You can assign each of the 4 voltage transformer inputs its own voltage transformer ratio.

- A voltage transformer ratio of 400 V / 400 V is factory-set for all 4 voltage transformer input.
- You can program voltage transformers with the same voltage transformer ratios in addresses 002 and 003.
- You can program voltage transformers with different voltage transformer ratios in addresses 012 to 043.
- Changing the voltage transformer values in addresses 002 or 003 overwrites the contents of addresses 012 to 043 with the voltage transformer values from addresses 002 and 003.

Address	Voltage transformer values
002	L1 L2 L3 L4 (primary)
003	L1 L2 L3 L4 (secondary)
012	L1 (primary)
013	L1 (secondary)
022	L2 (primary)
023	L2 (secondary)
032	L3 (primary)
033	L3 (secondary)
042	L4 (primary)
043	L4 (secondary)

### 11.4 Voltage connection variants

The device recognises two connection variants for voltage measurement.

#### Connection variant 0

- Direct voltage measurement in 3-phase 4-conductor networks.
- Measurement via 3 voltage transformers in 3-phase 4-conductor networks.
- Measurement in single-phase 3-conductor systems.

#### Connection variant 1

- Direct voltage measurement in three-phase 3-conductor networks.
- Measurement via 2 voltage transformers (Aron circuit ) in three-phase 3-conductor networks.

Address	Connection variant
111	0 = three phase 4-conductor networks (factory default setting)  1 = three-phase 3-conductor networks



#### NOTE!

It is not necessary to configure a connection schematic for measurement inputs L4 and I4.

### 11.5 RS232 configuration

The following data must be programmed to operate the RS232 interface:

- baud rate,
- operating mode.

For information on the factory default setting and the setting ranges, see the parameter list in section “17. Parameter list”.

Address	Settings
201	Baud rate, RS232 0 = 9600Bit/s 1 = 19200Bit/s 2 = 38400Bit/s 3 = 57600Bit/s 4 = 115200Bit/s
204	RS232. mode 0 = Modbus RTU/slave 3 = Debug 6 = SLIP (for internal use only)

### 11.6 RS485 configuration

The following data must be programmed to operate the RS485 interface:

- device address,
- baud rate,
- operating mode,

For information on the factory default setting and the setting ranges, see the parameter list in section “17. Parameter list”.

Address	Settings
200	Device address (1 to 255) applies to Modbus and Profibus 1 = factory default setting
202	Baud rate, RS485 0 = 9600Bit/s 1 = 19200Bit/s 2 = 38400Bit/s 3 = 57600Bit/s 4 = 115200Bit/s 5 = 921600Bit/s
203	RS485, mode 0 = Modbus RTU/slave 1 = Modbus RTU/master 2 = Gateway transparent

## 11.7 Ethernet configuration

### Static IP address

In simple networks with no DHCP server, the network address must be set right on the device itself.

### BootP

BootP enables the device to be integrated into an existing network fully automatically. However, BootP is an older protocol and does not provide the scope of functions provided by DHCP.

### DHCP mode

DHCP makes it possible integrate a UMG 604-PRO into an existing network fully automatically without the need for any additional configuration. When started, the device automatically obtains the IP address, the subnet mask and the gateway from the DHCP server. The device is factory-set to the DHCP client.

Address	Settings
205	DHCP mode 0 = static IP 1 = BootP 2 = DHCP client
300	IP address, xxx --- --- ---
301	IP address, --- xxx --- ---
302	IP address, --- --- xxx ---
303	IP address, --- --- --- xxx
304	IP mask, xxx --- --- ---
305	IP mask, --- xxx --- ---
306	IP mask, --- --- xxx ---
307	IP mask, --- --- --- xxx
310	IP gateway, xxx --- --- ---
311	IP gateway, --- xxx --- ---
312	IP gateway, --- --- xxx ---
313	IP gateway, --- --- --- xxx



### CAUTION!

### Damage to property due to incorrect network settings

Incorrect network settings can cause faults in the IT network.

**Obtain information from your network administrator about the correct settings for your device.**

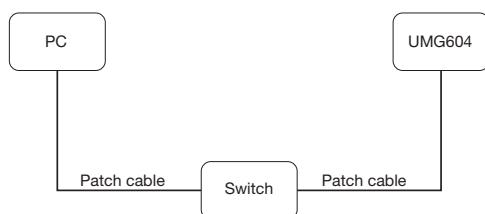


Fig. Connection example, the UMG 604-PRO and PC require a static IP address.

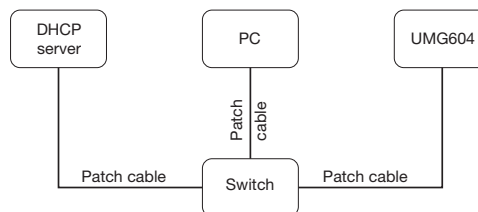


Fig. Connection example, the UMG 604-PRO and PC are automatically assigned an IP address by a DHCP server.

**11.8 Profibus configuration**

**11.8.1 Profiles**

The device can manage 16 Profibus profiles, each with a maximum of 128 data bytes.

The first data byte in the output box of the PLC always contains the profile number of the Profibus profile requested by the UMG.

In order to request a Profibus profile, write the profile number in the first byte in the PLC output box.

All system variables and global variables<sup>1)</sup> can be scaled individually and converted into one of the following formats:

- 8, 16, 32 bit integer with and without sign.
- 32 or 64 bit float format.
- Big or little endian<sup>2)</sup>.

1) Global variables are variables that the user defines in Jasic and are available to each interface in the UMG604  
 2) Big endian = high byte before low byte.  
 Little endian = low byte before high byte.

Address	Settings
200	Device address (1 to 255) applies to Modbus and Profibus 1 = factory default setting

Fig. Excerpt from the parameter list.

**11.8.2 Device master file**

The device master file, abbreviated as the GSD file, describes the Profibus characteristics of the UMG. The GSD file is required by the configuration program of the PLC.

The device master file for your device is called "OB41.GSD" and is available on the Janitza homepage.

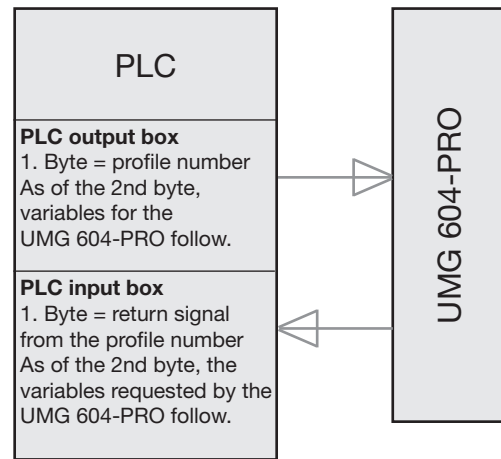


Fig. Block diagram for data exchange between PLC and UMG 604-PRO.

### 11. 8. 3 Pre-set profiles

#### Profibus profile number 0

1	1	Voltage L1-N	Float	1
2	5	Voltage L2-N	Float	1
3	9	Voltage L3-N	Float	1
4	13	Voltage L4-N	Float	1
5	17	Voltage L2-L1	Float	1
6	21	Voltage L3-L2	Float	1
7	25	Voltage L1-L3	Float	1
8	29	Current L1	Float	1
9	33	Current L2	Float	1
10	37	Current L3	Float	1
11	41	Current L4	Float	1
12	45	Active power L1	Float	1
13	49	Active power L2	Float	1
14	53	Active power L3	Float	1
15	57	Active power L4	Float	1
16	61	Cosphi (math.) L1	Float	1
17	65	Cosphi (math.) L2	Float	1
18	69	Cosphi (math.) L3	Float	1
19	73	Cosphi (math.) L4	Float	1
20	77	Frequency	Float	1
21	81	Total active power L1-L4	Float	1
22	85	Total reactive power L1-L4	Float	1
23	89	Total apparent power L1-L4	Float	1
24	93	Total cosphi (math.) L1-L4	Float	1
25	97	Total effective current L1-L4	Float	1
26	101	Total active energy L1-L4	Float	1
27	105	Ind. Total reactive energy L1-L4	Float	1
28	109	THD voltage L1	Float	1
29	113	THD voltage L2	Float	1
30	117	THD voltage L3	Float	1

**Profibus profile number 1**

1	1	Voltage L1-N	Float	1
2	5	Voltage L2-N	Float	1
3	9	Voltage L3-N	Float	1
4	13	Voltage L2-L1	Float	1
5	17	Voltage L3-L2	Float	1
6	21	Voltage L1-L3	Float	1
7	25	Current L1	Float	1
8	29	Current L2	Float	1
9	33	Current L3	Float	1
10	37	Active power L1	Float	1
11	41	Active power L2	Float	1
12	45	Active power L3	Float	1
13	49	Cosphi (math.) L1	Float	1
14	53	Cosphi (math.) L2	Float	1
15	57	Cosphi (math.) L3	Float	1
16	61	Frequency	Float	1
17	65	Total active power L1-L3	Float	1
18	69	Total reactive power L1-L3	Float	1
19	73	Total apparent power L1-L3	Float	1
20	77	Total cosphi (math.) L1-L3	Float	1
21	81	Total effective current L1-L3	Float	1
22	85	Total active energy L1-L3	Float	1
23	89	Ind. Total reactive energy L1-L3	Float	1
24	93	THD voltage L1	Float	1
25	97	THD voltage L2	Float	1
26	101	THD voltage L3	Float	1
27	105	THD current L1	Float	1
28	109	THD current L2	Float	1
29	113	THD current L3	Float	1



**Profibus profile number 2**

1	1	Total active energy L1-L3	Float	1
2	5	Rel. Total active energy L1-L3	Float	1
3	9	Deliv. Total active energy L1-L3	Float	1
4	13	Total reactive energy L1-L3	Float	1
5	17	Ind. Total reactive energy L1-L3	Float	1
6	21	Total cap. reactive energy L1-L3	Float	1
7	25	Total apparent energy L1-L3	Float	1
8	29	Active energy L1	Float	1
9	33	Active energy L2	Float	1
10	37	Active energy L3	Float	1
11	41	Inductive reactive energy L1	Float	1
12	45	Inductive reactive energy L2	Float	1
13	49	Inductive reactive energy L3	Float	1

**Profibus profile number 3**

1	1	Active power L1	Float	1
2	5	Active power L2	Float	1
3	9	Active power L3	Float	1
4	13	Total active power L1-L3	Float	1
5	17	Current L1	Float	1
6	21	Current L2	Float	1
7	25	Current L3	Float	1
8	29	Total current L1-L3	Float	1
9	33	Total active energy L1-L3	Float	1
10	37	CosPhi (math.) L1	Float	1
11	41	CosPhi (math.) L2	Float	1
12	45	CosPhi (math.) L3	Float	1
13	49	Total CosPhi (math.) L1-L3	Float	1
14	53	Reactive power L1	Float	1
15	53	Reactive power L2	Float	1
16	53	Reactive power L3	Float	1
17	53	Total reactive power L1-L3	Float	1
18	53	Apparent power L1	Float	1
19	53	Apparent power L2	Float	1
20	53	Apparent power L3	Float	1
21	53	Total apparent power L1-L3	Float	1

### 11.9 Recording configuration

2 recordings are pre-configured in the device's factory default setting.

Recordings are adjusted and expanded using the GridVis® software.

#### Recording 1

The following measured values are recorded with the time base of 15 minutes:

- Voltage effective L1
- Voltage effective L2
- Voltage effective L3
- Voltage effective L4
- Voltage effective L1-L2
- Voltage effective L2-L3
- Voltage effective L3-L1
- Current effective L1
- Current effective L2
- Current effective L3
- Current effective L4
- Active power L1
- Active power L2
- Active power L3
- Active power L4
- Total active power L1-L3
- Total active power L1-L4
- Reactive power fundamental oscillation L1
- Reactive power fundamental oscillation L2
- Reactive power fundamental oscillation L3
- Reactive power fundamental oscillation L4
- Total reactive power fundamental oscillation L1-L3
- Total reactive power fundamental oscillation L1-L4

(The mean value, minimum value, and maximum value are also recorded for each measured value.)

#### Recording 2

The following measured values are recorded with the time base of 1 hour:

- Active energy drawn L1
- Active energy drawn L2
- Active energy drawn L3
- Active energy drawn L4
- Total active energy drawn L1-L3
- Total active energy drawn L1-L4
- Inductive reactive energy L1
- Inductive reactive energy L2
- Inductive reactive energy L3
- Inductive reactive energy L4
- Total inductive reactive energy L1-L3
- Total inductive reactive energy L1-L4



## 12. System information

### 12.1 Measurement range exceeded

If the measurement range is exceeded, it is displayed as long as this persists and cannot be acknowledged. The measurement range is exceeded if at least one of the four voltage or current measurement inputs is outside its specified metering range.

If the measurement range is exceeded, this is shown on the display with "EEEE".

Symbols L1, L2, L3 and L4 are used to show the input on which the measurement range was exceeded. The "V" and "A" symbols indicate whether the measurement range has been exceeded in the current or voltage circuit.

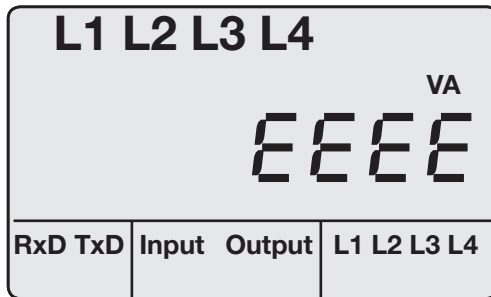


Fig. Measured value indication with measurement range exceeded.



**CAUTION!**

**Damage to property due to not observing the connection conditions**

Failure to observe the connection conditions can damage or destroy your device.

**Adhere to the specifications for voltage and frequency on the rating plate.**

### Serial number

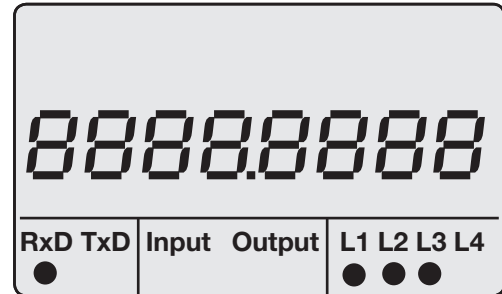


Fig. Measured value indication with serial number.

### Date

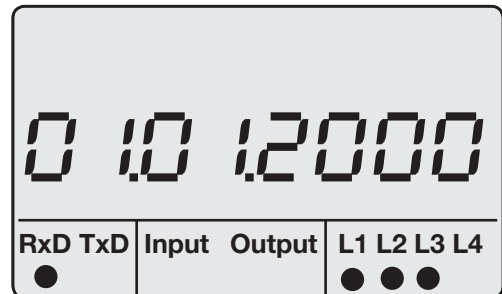


Fig. Measured value indication with date.

### Firmware release

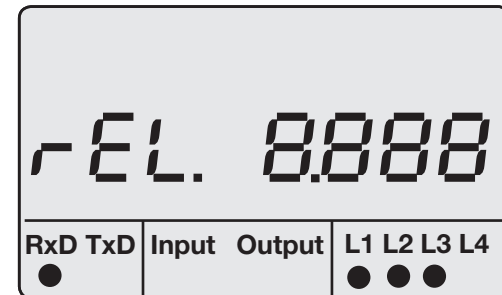


Fig. Measured value indication for the firmware release.

### Time

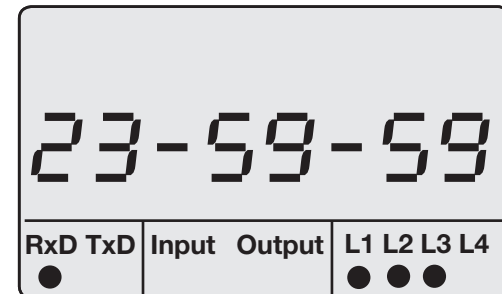


Fig. Measured value indication with time.



### 13. Device homepage

Your measurement device has an integrated web server, which has a separate homepage. You can use this device home page to access your measurement device from any end device via a standard web browser. You can access the homepage for your device by entering the device's IP address in a web browser on your end device. Section "11.7 Ethernet configuration" explains how to connect the device to the internet.

You can do the following here without first installing any software:

- call historical and current measured values.
- call the power quality status in an easy to understand illustration.
- control your device remotely.
- access installed apps.

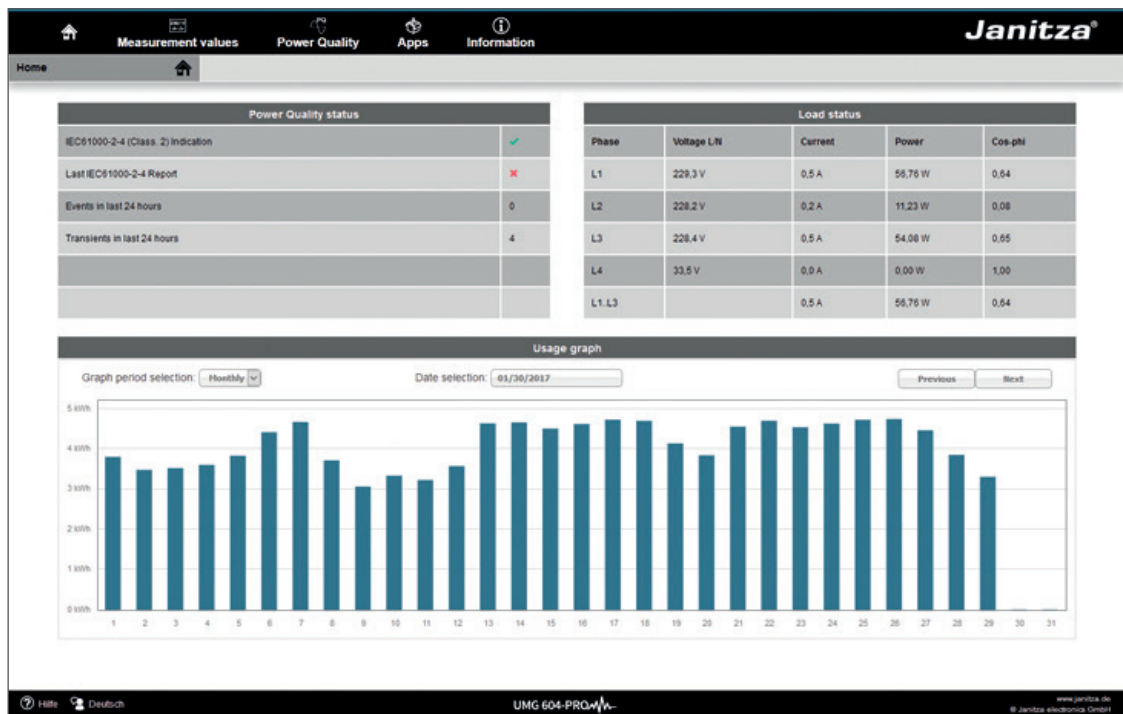


Fig. Device homepage overview

### 13.1 Measured values

You can use the *Measured values* menu item to call simple and detailed views of the measured values, and to display individual measured values. The following menu items are available:

- Short overview
- Detailed measured values
- Diagrams
- Events
- Transients

#### 13.1.1 Short overview

The *Short overview* provides you with the most important measured values for each phase, such as the current voltage values, power values and current strength.

Phase	U in V (L/L)	U in V (L/N)	Phase	kW	kWh	kvar	kvarh	Phase	I in A	cos.phi	THD-U	THD-I
L1/L2 L1/N	399,45	229,87	L1	0,02	35	0,00	-18	L1	0,11	0,97	2,25	63,55
L2/L3 L2/N	401,01	231,56	L2	0,01	29	0,00	-12	L2	0,04	0,89	1,76	27,04
L3/L1 L3/N	400,31	231,89	L3	0,01	14	-0,01	-14	L3	0,04	0,77	1,82	54,63
L4/N		39,57	L4	0,00	0	0,00	0	L4	0,00	1,00	36,43	---
			L1..L3	0,04	80	-0,01	-45	L1..L3	0,09	0,93		
			L1..L4	0,04	80	-0,01	-45	L1..L4	0,09	0,93		

Fig. Short overview of measured values

### 13. 1. 2 Detailed measured values

In the overview, you can call extensive information on the following points:

- Voltage
- Current
- Power
- Harmonic oscillations
- Energy
- Peripheral devices (digital inputs/outputs, temperature measurements)

Voltage				
Voltage Effective				
	Actual value	Average value	Minimum value	Maximum value
L1	229.6 V	229.6 V	38.0 V	236.6 V
L2	230.8 V	230.6 V	37.9 V	237.0 V
L3	231.2 V	231.4 V	37.9 V	237.3 V
L4	25.4 V	25.5 V	14.0 V	59.4 V
L1-L2	298.7 V	298.5 V	0.2 V	410.1 V
L2-L3	399.8 V	399.7 V	0.6 V	410.7 V
L3-L1	399.8 V	399.8 V	0.7 V	410.8 V
Three-phase Values				
	Actual value	Average value	Minimum value	Maximum value
Unbalance Voltage	0.2 %	0.2 %	0.0 %	100.0 %
Frequency				
	Actual value	Average value	Minimum value	Maximum value
Frequency	50.0 Hz	50.0 Hz	0.0 Hz	50.1 Hz

Current

Power

Harmonics

Energy

Fig. Detailed overview of measured values



### 13. 1. 3 Diagrams

You can use the “Diagrams” item to access the measured values monitor. The measured values monitor is a configurable display of current and historical measured values with automatic scaling. In order to display a graphic of the measured values, drag the required values from the list on the left edge of the screen into the field in the middle of the screen.

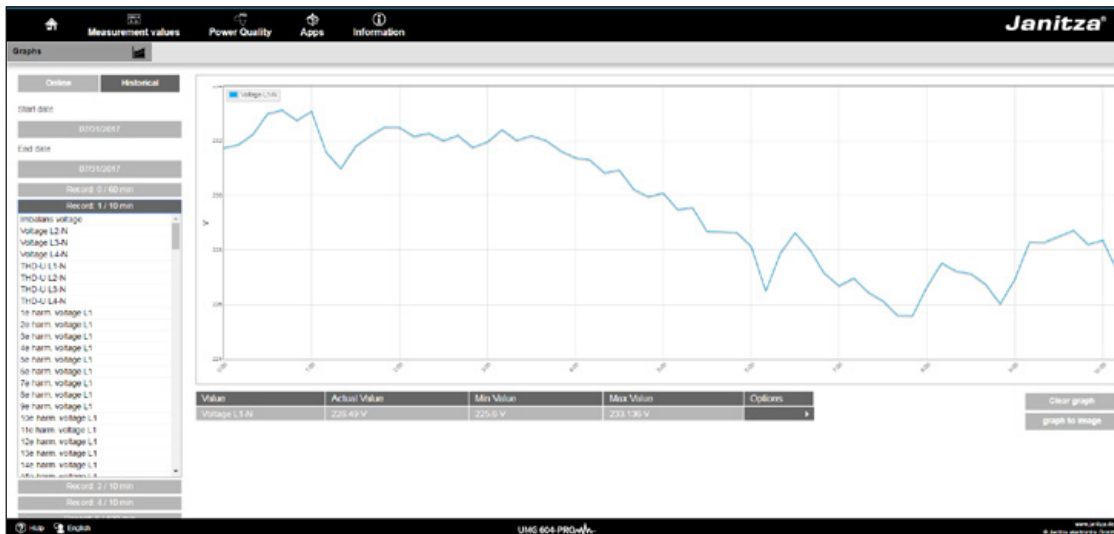


Fig. Device homepage event records

### 13. 1. 4 Events

You can use events item to display a graphical illustration of the recorded events such as overcurrent or undervoltage by clicking the relevant event in the list.

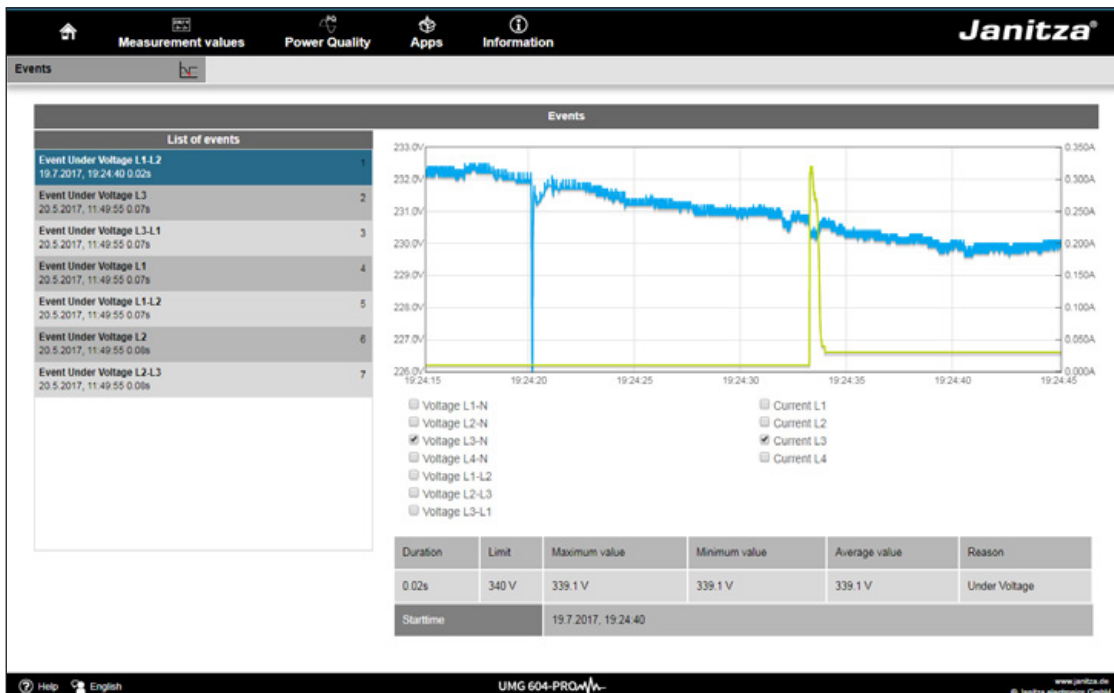


Fig. Event records

### 13. 1. 5 Transients

The “Transients” area provides a graphic illustration of transients within a date list. Transient voltages:

- are fast impulse transient effects in electrical networks.
- are unpredictable from a time perspective and have a limited duration.
- are caused by lightning strikes, switching operations or by tripped fuses.

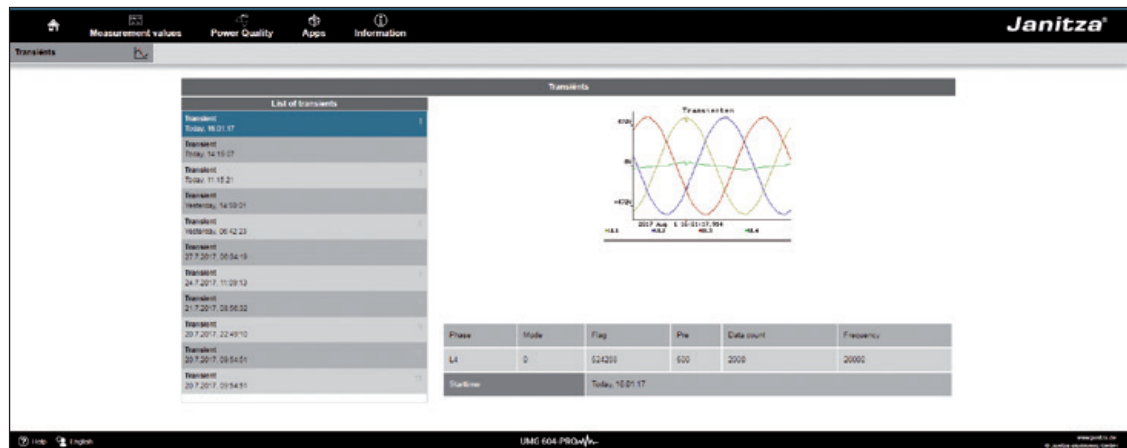


Fig. Transients

### 13.2 Power quality

The “Power quality” section (PQ) provides you with the option of calling the PQ status in a clear way according to common standards. Here, you have access to permanent power quality monitoring in accordance with:

- IEC 61000-2-4 in customer supply networks.

The display is based on the traffic light principle, which makes it easy to detect events that do not meet the relevant quality requirements without in-depth knowledge.

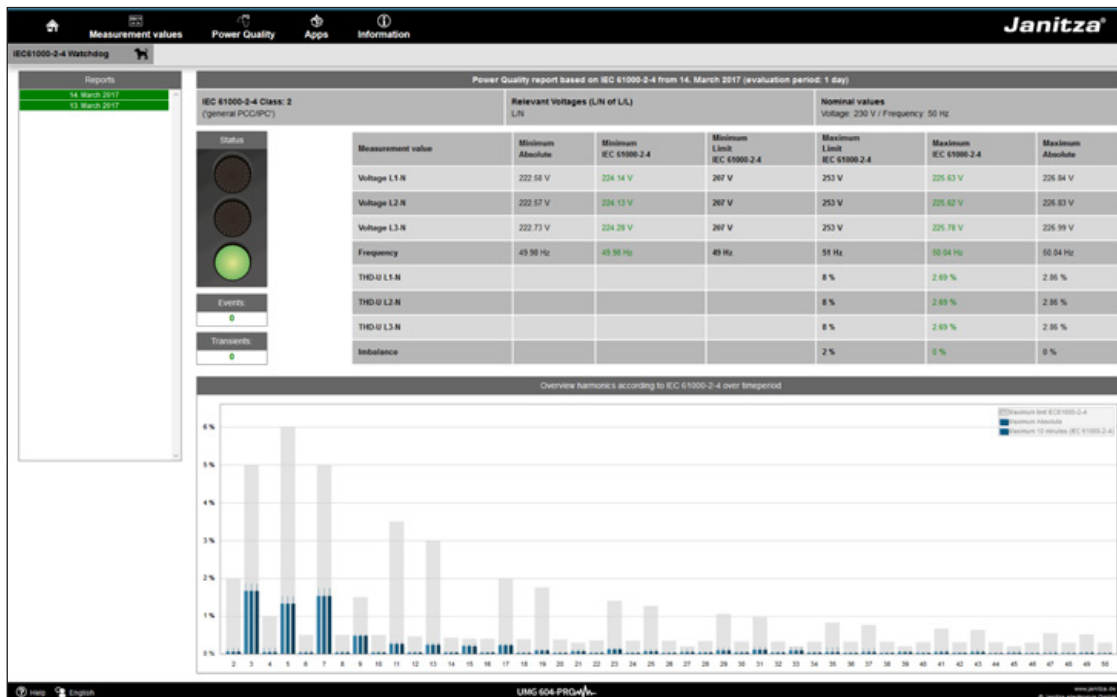


Fig. IEC 61000-2-4 parameters with traffic-light principle

### 13.3 Apps

You have the option of extending the functions on your device retrospectively by installing additional apps.

#### 13.3.1 Push Service

The push service is an example of an installable app. The push service sends measured values directly from the device to a cloud or portal solution chosen by you, such as the Janitza Energy Portal

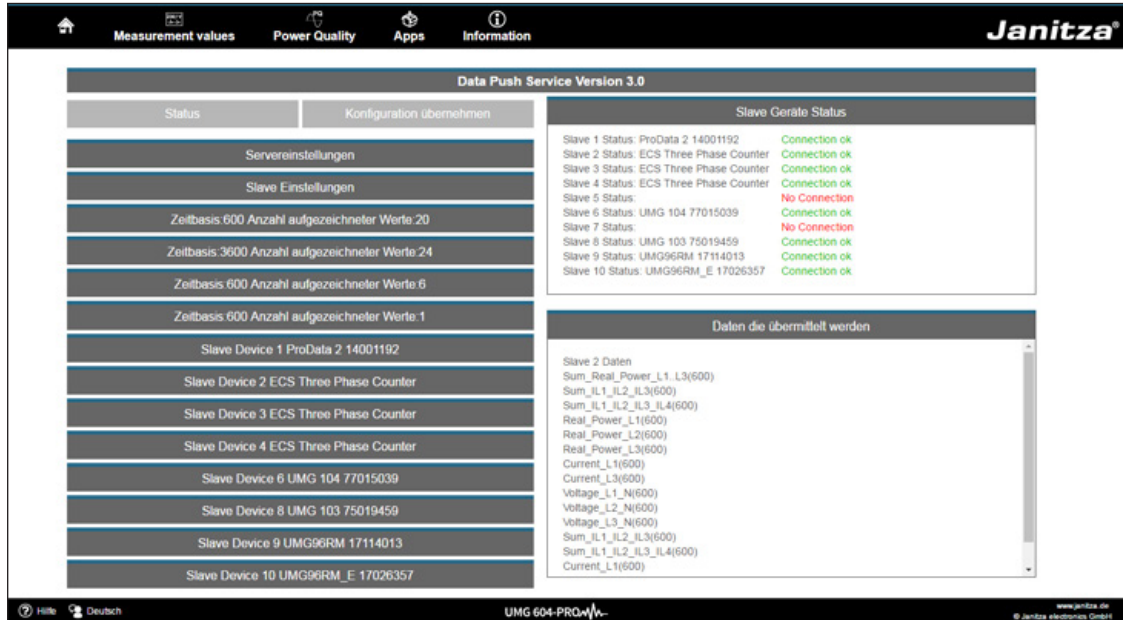


Fig. Push Service

## 13.4 Information

### 13.4.1 Device information

You can use the *Device information* menu item to obtain all information and settings that you can change on the device.

### 13.4.2 Downloads

You can use the *Downloads* item to access the download area on the Janitza homepage. You can download catalogues, operation manuals and additional documentation from here.

### 13.4.3 Display

The *Display* item provides you with the display of your device, which corresponds to the real display.

You can control the device remotely here by clicking the control buttons using the mouse.

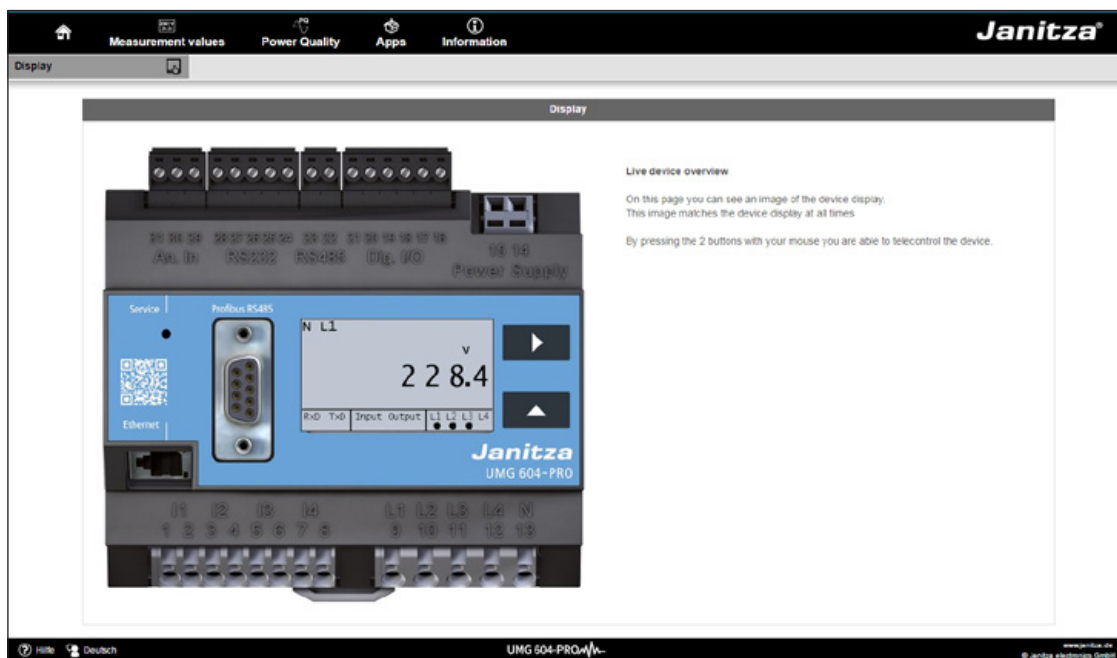


Fig. Operating the UMG 604-PRO via the device homepage

## 14. Service and maintenance

The device underwent various safety checks before delivery and is marked with a seal. If a device is open, the safety checks must be repeated. Warranty claims will only be accepted if the device is unopened.

### 14.1 Repair and calibration

Repair work and calibration can be carried out by the manufacturer only.

### 14.2 Front film

The front film can be cleaned with a soft cloth and standard household cleaning agent. Do not use acids and products containing acid for cleaning.

### 14.3 Disposal

Observe the national regulations! If necessary, dispose of individual parts according to their properties and existing country-specific regulations, e.g. as:

- Electronic waste
- Plastics
- Metals

or commission a certified disposal company with scrapping.

### 14.4 Service

Should questions arise, which are not described in this manual, please contact the manufacturer directly.

We will need the following information from you to answer any questions:

- device name (see rating plate),
- serial number (see rating plate),
- software release (see measured value indication),
- measured voltage and supply voltage,
- precise description of the error.

### 14.5 Battery

The internal clock is fed from the supply voltage.

If the supply voltage fails then the clock is powered by the battery.

The clock provides date and time information, for the records, min. and max. values and events, for example.

The life expectancy of the battery is at least 5 years with a storage temperature of +45°C. The typical life expectancy of the battery is 8 to 10 years.

The device must be opened to change the battery.



#### NOTE!

If the device has been opened, a new safety inspection must be carried out to ensure safe operation. Warranty claims will only be accepted if the device is unopened.

### 14.6 Firmware update

In order to carry out a firmware update, connect the device to a computer via Ethernet and access it using the GridVis® software.

Open the firmware update wizard by clicking "Update device" in the "Extras" menu.

Select the relevant update file and carry out the update.



#### NOTE!

Firmware may **not** be updated via the RS485 interface.



## 15. Procedure in the event of faults

Possible fault	Cause	Remedy
No display	External fuse for the power supply voltage has tripped.	Replace fuses.
	Device defective.	Send the device to the manufacturer for repair.
No current display	Measured voltage is not connected.	Connect the measured voltage.
	Measurement current is not connected.	Connect measuring-circuit current.
Displayed current is too high or too low	Current measurement in the wrong phase.	Check connection and correct if necessary.
	Current transformer factor is incorrectly programmed.	Read out and program the CT ratio on the current transformer.
Voltage displayed is too high or too low.	Measurement in the wrong phase.	Check connection and, if necessary, correct.
	Voltage transformer incorrectly programmed.	Read out and program the voltage transformer ratio at the voltage transformer.
Voltage displayed is too low.	Measurement range exceeded.	Use voltage transformers.
	The peak voltage value at the measurement input has been exceeded by the harmonics.	<b>Attention!</b> Ensure the measurement inputs are not overloaded.
“EEEE” and “V” on the display	The voltage measurement range has been exceeded.	Check the measured voltage and install a suitable voltage transformer if necessary.
“EEE” and “A” on the display	The current measurement range has been exceeded.	Check the measured current and install a suitable current transformer if necessary.

Table Procedure in the event of faults, part 1



Possible fault	Cause	Remedy
"Error CF" on the display	The calibration data could not be read.	Send the device to the manufacturer for inspection and testing along with an accurate fault description.
Active power, consumption/supply reversed.	At least one current transformer connection is mixed up/reversed.	Check connection and correct if necessary.
	A current circuit is assigned to the wrong voltage circuit.	Check connection and correct if necessary.
Active power too high or too low.	The programmed CT ratio is incorrect.	Read out and program the CT ratio on the current transformer
	The current circuit is assigned to the wrong voltage circuit.	Check connection and correct if necessary.
	The programmed voltage transformer ratio is incorrect.	Read out and program the voltage transformer ratio at the voltage transformer.
No connection to the device.	RS485: - Incorrect device address. - Wrong protocol. - Termination missing.	Set the device address. Select the protocol. Terminate the bus with a termination resistor (120 ohm).
	Ethernet: - Incorrect IP address - The hidden button (Service) was pressed.	Set the IP address on the device. Describe address 204 with 0 and set the IP address or activate DHCP.
Device still does not work despite the above measures.	Device defective.	Send the device to the manufacturer for inspection, along with an accurate fault description .

Table Procedure in the event of faults, part 2

## 16. Technical data

### 16.1 General

Net weight	350 g
Device dimensions	Approx. l=107.5 mm, w=90 mm, h=82 mm (per DIN 43871:1992)
Housing flammability rating	UL 94V-0
Installation position	any
Fastening/assembly	35 mm DIN rail (per IEC/EN60999-1, DIN EN 50022)
Battery	Type Lithium CR2032, 3 V (approval i.a.w. UL 1642)
Service life of the backlight (optional)	40000 h (50% of the initial brightness)

### 16.2 Environmental conditions

The device is intended for weatherproof, fixed installation and meets the operational conditions in accordance with DIN IEC 60721-3-3.

Working temperature range	-10 °C to +55 °C
Relative humidity	5 to 95% RH, (at +25 °C) without condensation
Pollution degree	2
Operating altitude	0 to 2000 m above sea level
Installation position	any
Ventilation	Forced ventilation is not required.

### 16.3 Transport and storage

The following information applies to devices which are transported or stored in the original packaging.

Free fall	1 m
Temperature	-20 °C to +70 °C

#### 16.4 Supply voltage

The supply voltage must be connected through a UL/IEC approved fuse (6A char. B) to the device.

230 V option: <ul style="list-style-type: none"> <li>• Nominal range</li> <li>• Operating range</li> <li>• Power consumption</li> <li>• Overvoltage category</li> </ul>	95 V to 240 V (50/60 Hz) / DC 135 V to 340 V +-10% of nominal range max. 3.2 W / 9 VA 300 V CATII
90 V option (without UL approval): <ul style="list-style-type: none"> <li>• Nominal range</li> <li>• Operating range</li> <li>• Power consumption</li> <li>• Overvoltage category</li> </ul>	50 V to 110 V (50/60 Hz) / DC 50 V to 155 V +-10% of nominal range max. 3.2 W / 9 VA 300 V CATII
24V option: <ul style="list-style-type: none"> <li>• Nominal range</li> <li>• Operating range</li> <li>• Power consumption</li> <li>• Overvoltage category</li> </ul>	20 V to 50 V (50/60Hz) / DC 20 V to 70 V +-10% of nominal range max. 5 W / 8 VA 150 V CATII

<b>Terminal connection capacity (supply voltage)</b>	
Connectable conductors. Only one conductor can be connected per terminal!	
Single core, multi-core, fine-stranded	0.08 - 2.5 mm <sup>2</sup> , AWG 28 - 12
Terminal pins, core end sheath	1.5 mm <sup>2</sup> , AWG 16

#### 16.5 Protection class

Protection class II in accordance with IEC 60536 (VDE 0106, part 1), i.e. a ground wire connection is not required!

Protection against ingress of solid foreign bodies and water	IP20 in accordance with EN60529 September 2014, IEC60529:2013
--	---

## 16.6 Digital inputs and outputs

<b>Digital inputs</b>	
Maximum counter frequency (Pulse input S0)	20 Hz
Switching input	
Input signal present	18 V to 28 V DC (typical 4 mA)
Input signal not present	0 to 5 V DC, current less than 0.5 mA
Response time (Jasic program)	200 ms
Cable length	up to 30 m unshielded, from 30 m shielded

<b>Digital outputs</b>	
2 digital outputs; semiconductor relays, not short-circuit proof	
Switching voltage	max. 60 V DC, 30 V AC
Switching current	max. 50 mAeff AC/DC
Response time (Jasic program)	200 ms
Output of voltage dips	20 ms
Output of voltage exceedance events	20 ms
Switching frequency	max. 20 Hz
Cable length	up to 30 m unshielded, from 30 m shielded

<b>Terminal connection capacity</b>	
Connectable conductors.	
Single core, multi-core, fine-stranded	0.08 - 1.5 mm <sup>2</sup>
Terminal pins, core end sheath	1 mm <sup>2</sup> Only one conductor can be connected per terminal!

<b>Potential separation and electrical safety for the digital inputs and outputs</b>	
<ul style="list-style-type: none"> <li>• The digital inputs and outputs are double-insulated from the current and voltage measurement inputs, as well as the supply voltage.</li> <li>• There is only a functional insulation from the Ethernet, Profibus, RS485 and RS232 interfaces, the temperature measurement input, and from one another.</li> <li>• The external auxiliary voltage to be connected must be compliant with SELV or PELV.</li> </ul>	

## 16.7 Temperature measurement input

<b>Temperature measurement input</b> 3-wire measurement	
Update time	Approx. 200 ms
Connectable sensors	PT100, PT1000, KTY83, KTY84
Total burden (sensor + cable)	max. 4 kOhm
Cable length	up to 30 m unshielded, from 30 m shielded

Sensor type	Temperature range	Resistor range	Measurement uncertainty
KTY83	-55 °C to +175 °C	500 Ohm to 2.6 kOhm	± 1.5% rng <sup>1)</sup>
KTY84	-40 °C to +300 °C	350 Ohm to 2.6 kOhm	± 1.5% rng <sup>1)</sup>
PT100	-99 °C to +500 °C	60 Ohm to 180 Ohm	± 1.5% rng <sup>1)</sup>
PT1000	-99 °C to +500 °C	600 Ohm to 1.8 kOhm	± 1.5% rng <sup>1)</sup>

<sup>1)</sup> rng = metering range

<b>Terminal connection capacity (temperature measurement input)</b>	
Single core, multi-core, fine-stranded	0.08 - 1.5 mm <sup>2</sup>
Terminal pins, core end sheath	1 mm <sup>2</sup> Only one conductor can be connected per terminal!

<b>Potential separation and electrical safety for the temperature measurement input</b>
<ul style="list-style-type: none"> <li>• The temperature measurement input is double-insulated from the current and voltage measurement inputs, as well as the supply voltage.</li> <li>• There is no insulation from the RS232 and RS485 interfaces.</li> <li>• There is only a functional insulation from the Ethernet and Profibus interfaces, and the digital inputs / outputs.</li> <li>• The external temperature sensor must be double insulated from the system parts that carry voltages that are dangerous to touch (per IEC61010-1:2010).</li> </ul>

### 16.8 Voltage measurement inputs

Three-phase 4-conductor systems (L-N/L-L)	max. 277 V / 480 V
Three-phase 3-conductor systems (L-L)	max. 480 V
Resolution	0.01 V
Metering range L-N	0 <sup>1)</sup> to 600 Vrms
Metering range L-L	0 <sup>1)</sup> to 1000 Vrms
Crest factor	2 (related to 480 Vrms)
Overvoltage category	300 V CAT III
Measurement surge voltage	4 kV
Protection of voltage measurement	1 - 10 A
Impedance	4 MOhm / phase
Power consumption	approx. 0.1 VA
Sampling rate	20 kHz / phase
Transients	> 50 µs
Frequency of the fundamental oscillation	45 Hz to 65 Hz
- Resolution	0.001 Hz

<sup>1)</sup> The UMG device can only determine measured values if at least one voltage measurement input has an L-N voltage of greater than 10 Veff or an L-L voltage of greater than 18 Veff.

### 16.9 Current measurement inputs

Rated current	5 A
Rated current	6 A
Protection when measuring directly (without a current transformer)	6 A, char. B (approved i.a.w. UL/IEC)
Resolution on the display	10 mA
Metering range	0.005 to 7 Amps
Crest factor	2 (related to 6 Amps)
Overvoltage category	300 V CAT III
Measurement surge voltage	4 kV
Power consumption	approx. 0.2 VA (Ri = 5 mOhm)
Overload for 1 sec.	100 A (sinusoidal)
Sampling rate	20 kHz

Measurement precision phase angle	0,15°
-----------------------------------	-------

<b>Terminal connection capacity (current measurement and voltage measurement)</b> Connectable conductors. Only one conductor can be connected per terminal!	
Single core, multi-core, fine-stranded	0.08 - 4 mm <sup>2</sup> , AWG 28 - 12
Terminal pins, core end sheath	2.5 mm <sup>2</sup> , AWG 14

## 16.10 Interfaces

<b>RS232 interface</b>	
Connection	5-pin screw-type terminals
Protocol	Modbus RTU/slave
Transmission rate	9.6 kbps, 19.2 kbps, 38.4 kbps, 57.6 kbps, 115.2 kbps

<b>RS485 interface</b>	
Connection	2-pin screw-type terminals
Protocol	Modbus RTU/slave, Modbus RTU/master
Transmission rate	9.6 kbps, 19.2 kbps, 38.4 kbps, 57.6 kbps, 115.2 kbps, 921.6 kbps

<b>Profibus interface (optional)</b>	
Connection	SUB D 9-pin
Protocol	Profibus DP/V0 per EN 50170
Transmission rate	9.6 kBaud to 12 MBaud

<b>Ethernet interface</b>	
Connection	RJ45
Function	Modbus gateway, embedded web server (HTTP)
Protocols	TCP/IP, EMAIL (SMTP), DHCP client (BootP), Modbus/TCP(port 502), ICMP (ping), NTP, TFTP, Modbus RTU over Ethernet (port 8000), FTP SNMP.

<b>Potential separation and electrical safety for the interfaces</b>	
<ul style="list-style-type: none"> <li>• The RS485, RS232, Profibus and Ethernet interfaces are double-insulated from the current and voltage measurement inputs, as well as the supply voltage.</li> <li>• The RS232 and RS485 interfaces are not insulated from each other and from the temperature measurement input.</li> <li>• The Profibus and Ethernet interfaces have a functional insulation form each other and from RS232, RS485, the temperature measurement input and digital inputs and outputs.</li> <li>• The interfaces for the devices connected here must have a double or reinforced insulation to mains voltages (in accordance with IEC 61010-1: 2010).</li> </ul>	

### 16.11 Measurement uncertainty

Measurement uncertainty on the device applies when using the following metering ranges. The measured value must be within the specified limits. The measurement uncertainty is not specified outside of these limits.

Measured value	Measurement uncertainties
Voltage	$\pm 0.2\%$ per DIN EN 61557-12:2008
Current L	$\pm 0.25\%$ in accordance with DIN EN 61557-12:2008
Current N	$\pm 1\%$ per DIN EN 61557-12:2008
Power	$\pm 0.4\%$ per DIN EN 61557-12:2008
Harmonics U, I	Class 1, DIN EN 61000-4-7
Active energy	
Current transformer .. /5 A	Class 0.5S (DIN EN62053-22:2003, IEC62053:22:2003)
Current transformer .. /1 A	Class 1 (DIN EN62053-21:2003, IEC62053:21:2003)
Reactive energy	
Current transformer .. /5 A	Class 2 (DIN EN62053-23:2003, IEC62053:23:2003)
Current transformer .. /1 A	Class 2 (DIN EN62053-23:2003, IEC62053:23:2003)
Frequency	$\pm 0.01$ Hz
Internal clock	$\pm 1$ minute/month (18 °C to 28 °C)

The specification applies under the following conditions:

- annual re-calibration,
- a warm-up time of 10 minutes,
- an ambient temperature of 18 to 28 °C.

If the device is operated outside the range of 18 to 28 °C, an additional measurement error of  $\pm 0.01\%$  of the measured value per °C deviation must be considered.





## 17. Parameter list

Address	Designation	Setting range	Unit	Default
000	Current transformer, primary, L1 to L4	0 to 1000000	A	5
001	Current transformer, secondary, L1 to L4	1 to 5	A	5
002	Voltage transformer, primary, L1 to L4	0 to 1000000	V	400
003	Voltage transformer, secondary, L1 to L4	1 to 400	V	400
010	Current transformer, primary, L1	0 to 1000000	A	5
011	Current transformer, secondary, L1	1 to 5	A	5
012	Voltage transformer, primary, L1	0 to 1000000	V	400
013	Voltage transformer, secondary, L1	1 to 400	V	400
020	Current transformer, primary, L2	0 to 1000000	A	5
021	Current transformer, secondary, L2	1 to 5	A	5
022	Voltage transformer, primary, L2	0 to 1000000	V	400
023	Voltage transformer, secondary, L2	1 to 400	V	400
030	Current transformer, primary, L3	0 to 1000000	A	5
031	Current transformer, secondary, L3	1 to 5	A	5
032	Voltage transformer, primary, L3	0 to 1000000	V	400
033	Voltage transformer, secondary, L3	1 to 400	V	400
040	Current transformer, primary, L4	0 to 1000000	A	5
041	Current transformer, secondary, L4	1 to 5	A	5
042	Current transformer, primary, L4	0 to 1000000	V	400
043	Voltage transformer, secondary, L4	1 to 400	V	400

Table Parameter list for measurement settings

Address	Designation	Setting range	Unit	Default
100	Collect TFTP configuration file automatically 0 = deactivated x = file number	0 to 9999	-	0
101	TFTP error handling 0 = in the event of an error, the configuration menu is shown on the display. 1 = TFTP error handling in the device is deactivated	0 to 1	-	0
110	Current transformer switch (L1 to L3) 0 = three current transformers 1 = two current transformers (Aron circuit)	0 to 1	-	0
111	Voltage measurement network configuration 0 = three-phase 4-conductor system (TT, TN network) 1 = three-phase 3-conductor system (IT network)	0 to 1	-	0
112	Deletes all active energy counters, apparent energy counters and S0 counters (1 = delete)	0 to 1	-	0
113	Deletes all reactive energy counters (1 = delete)	0 to 1	-	0
114	Resets all min. and max. values (1 = reset)	0 to 1	-	0

Table Parameter list for measurement settings

Address	Designation	Setting range	Unit	Default
200	Device address, Modbus/Profibus	1 to 255	-	1
201	Baud rate, RS232 0 = 9600Bit/s 1 = 19200Bit/s 2 = 38400Bit/s 3 = 57600Bit/s 4 = 115200Bit/s	0 to 4	-	4
202	Baud rate, RS485 0 = 9600Bit/s 1 = 19200Bit/s 2 = 38400Bit/s 3 = 57600Bit/s 4 = 115200Bit/s 5 = 921600Bit/s	0 to 5	-	4
203	RS485, mode 0 = Modbus RTU/slave 1 = Modbus RTU/master 2 = Gateway transparent	0 to 6	-	0
204	RS232, mode 0 to 6 0 = Modbus RTU/slave 3 = Debug 6 = SLIP (for internal use only)	0 to 6	-	0

Table Parameter list for bus settings

Address	Designation	Setting range	Unit	Default
205	DHCP mode 0 = static IP 1 = BootP 2 = DHCP client	0,1,2	-	2
300	IP address, xxx --- --- ---	0 to 255	-	000
301	IP address, --- xxx --- ---	0 to 255	-	000
302	IP address, --- --- xxx ---	0 to 255	-	000
303	IP address, --- --- --- xxx	0 to 255	-	000
304	IP mask, xxx --- --- ---	0 to 255	-	000
305	IP mask, --- xxx --- ---	0 to 255	-	000
306	IP mask, --- --- xxx ---	0 to 255	-	000
307	IP mask, --- --- --- xxx	0 to 255	-	000
310	IP gateway, xxx --- --- ---	0 to 255	-	000
311	IP gateway, --- xxx --- ---	0 to 255	-	000
312	IP gateway, --- --- xxx ---	0 to 255	-	000
313	IP gateway, --- --- --- xxx	0 to 255	-	000

Table Parameter list for Ethernet settings

Address	Designation	Setting range	Unit	Default
400	Day	1 to 31	-	xx
401	Month	1 to 12	-	xx
402	Year	1 to 9999	-	xxxx
403	Hour	0 to 23	-	xx
404	Minute	0 to 59	-	xx
405	Second	0 to 59	-	xx
406	Copy date and time 1 = copy set data	0, 1	-	0
500	Device password	0 to 9999	-	xxxx
501	Homepage, password mode	0, 2, 128, 130	-	0
502	Homepage, password	0 to 9999	-	xxxx
510	Enabling "EMAX" option, licence part 1	0 to 9999	-	xxxx
511	Enabling "EMAX" option, licence part 2	0 to 9999	-	xxxx
520	Enabling "BACnet" option, licence part 1	0 to 9999	-	xxxx
521	Enabling "BACnet" option, licence part 2	0 to 9999	-	xxxx
600	LCD, contrast	0 to 99	-	50
601	LCD, backlight, max. brightness	0 to 16	-	10
602	LCD, backlight, min. brightness	0 to 8	-	3
603	LCD, backlight, time until switching from maximum to minimum brightness.	0 to 9999	s	60

*Table Parameter list for other settings*

### 18. Measured value indications

You can use buttons 1 and 2 on the display to display the following measured values in the factory default setting. The measured value designations used are abbreviated and have the following meanings:

- Active power = active power, consumption
- Reactive power= reactive power, inductive
- Active energy = active energy, consumption with backstop

Voltage L1-N	Voltage L2-N	Voltage L3-N	Voltage L4-N		
Voltage L1-L2	Voltage L2-L3	Voltage L3-L1			
Current L1	Current L2	Current L3	Current L4		
Active power L1	Active power L2	Active power L3	Active power L4	Active power L1 to L3	Active power L1 to L4
Reactive power L1	Reactive power L2	Reactive power L3	Reactive power L4	Reactive power L1 to L3	Reactive power L1 to L4
Active energy L1	Active energy L2	Active energy L3	Active energy L4	Active energy L1 to L3	Active energy L1 to L4
cos(phi) L1	cos(phi) L2	cos(phi) L3	cos(phi) L4	cos(phi) L1 to L3	
Frequency rotation field	Temperature measurement input	Date	Time	Serial number	Firmware release



19. Dimension diagrams

19.1 Front view

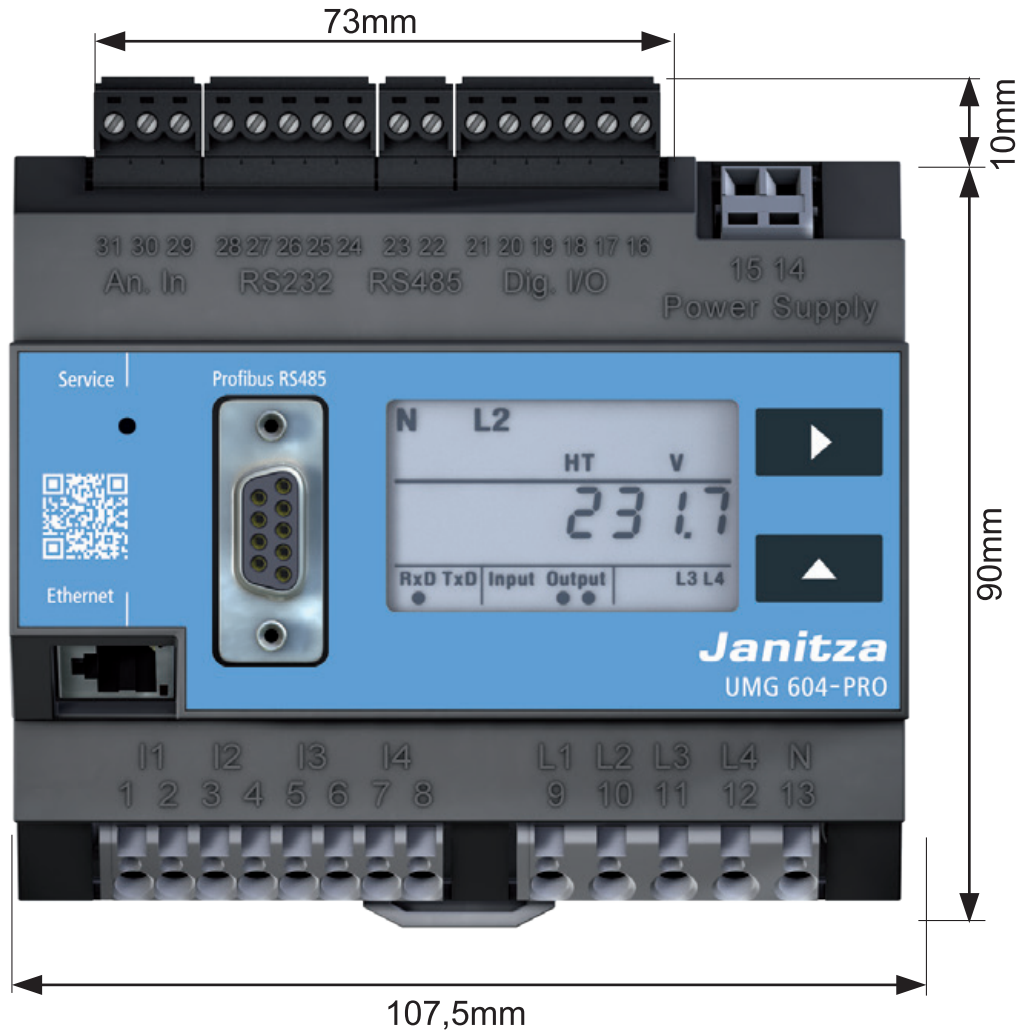


Fig. Front view of UMG 604-PRO with installation dimensions



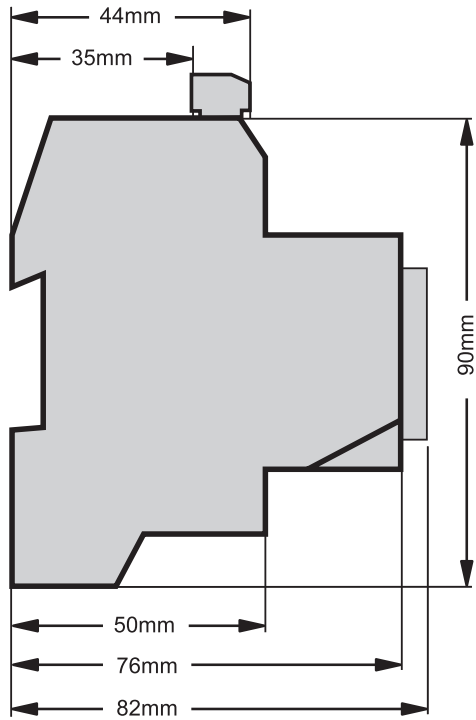
**19.2 Side view**

Fig. Schematic side view of UMG 604-PRO with installation dimensions

20. Connection example

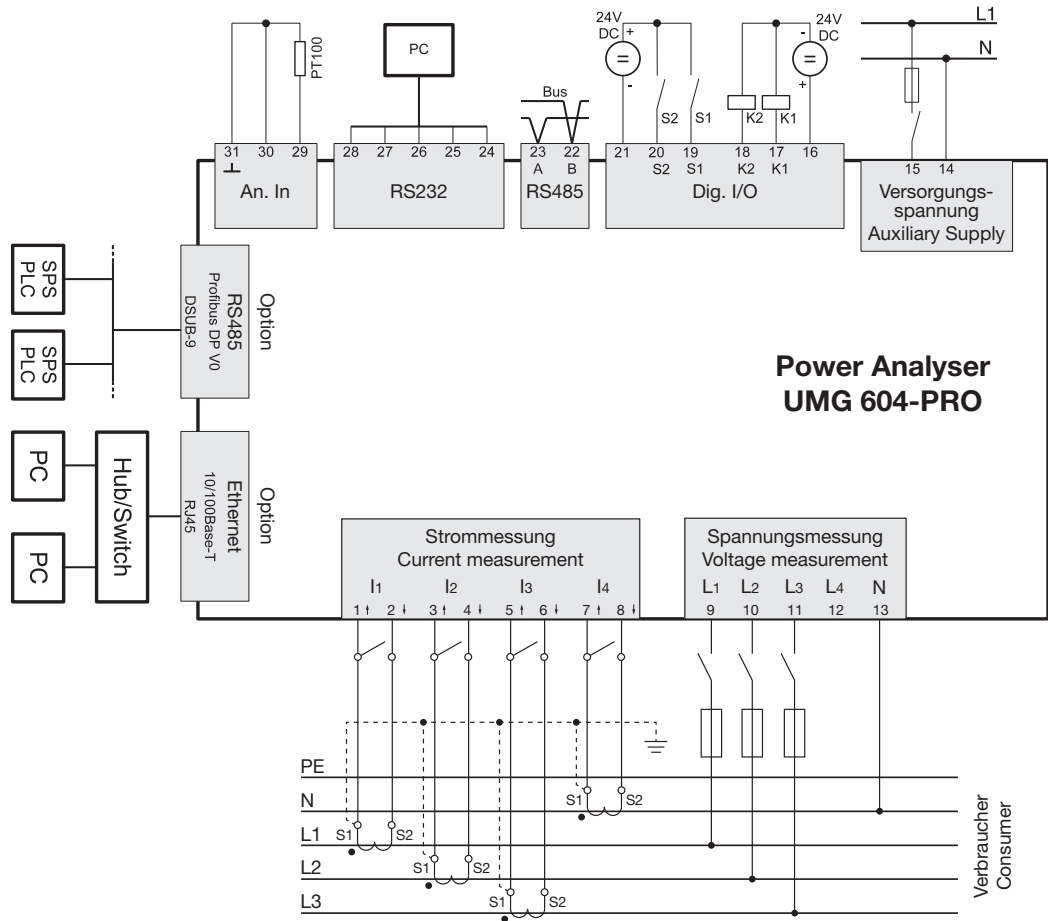


Fig. Connection example for UMG 604-PRO



## 21. Short introduction (setting primary current)

You have three identical current transformers with a current transformer ratio of 200 A / 5 A. You want to program the primary current of 200 A. To do this, you must enter the value 200 for the primary current in address 000. The secondary current is factory-set to 5 A in address 001.

1. Switch to programming mode by pressing buttons 1 and 2 simultaneously for approximately one second.
  - The symbol for programming mode PRG appears.
  - The contents of address 000 are displayed.
2. Enter the primary current by using button 1 to select the number to be changed and button 2 to change the selected number.
3. Exit programming mode by pressing buttons 1 and 2 simultaneously again for approximately one second.
  - The current transformer setting is saved.
  - The device returns to display mode.

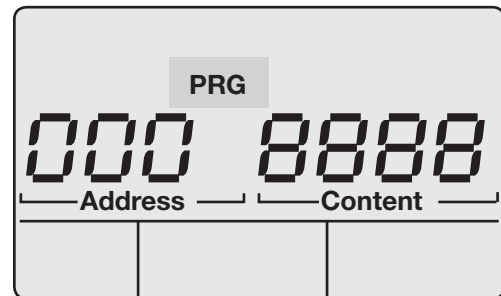


Fig. UMG 604-PRO display in programming mode

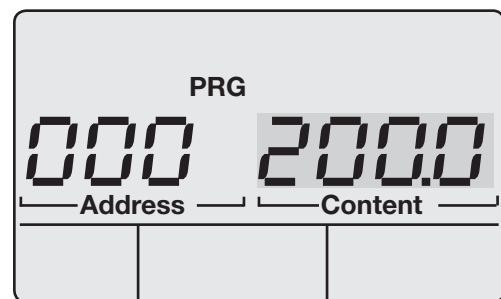


Fig. UMG 604-PRO display in programming mode

