

NON-MAINTAINED LUMINARIES



TECHNICAL CHARACTERISTICS (for LED MODULE specifications see page 4)				
	GR-470	GR-471	GR-472	GR-473
OPERATION VOLTAGE	220-240V AC / 50-60Hz			
MAXIMUM POWER CONSUMPTION	2,6W / 2,9VA			
BATTERY (Ni-Cd)	3,6V/1 Ah			
BATTERY PROTECTION	Deep discharge and overcharge protection			
INDICATIONS	Charge LED, Magnetic Test Contact			
CHARGE TIME	24 hours			
MINIMUM DURATION	1,5 hour			3 hour
LIGHT SOURCE	1 white power LED			
EMERGENCY ILLUMINATION	145lm			80lm
DEGREES OF COVER PROTECTION	IP42			
PRODUCED IN ACCORDANCE WITH	EN 60598-1, EN 60598-2-22, EN 55015, EN 61547, EN 61000-3-2, EN 61000-3-3			
OPERATION TEMPERATURE RANGE	5 to 40 °C			
RELATIVE HUMIDITY	Up to 95%			
CONSTRUCTION MATERIAL	ABS/PC, PC			
EXTERNAL DIMENSION	158 x 158 x 60,4mm (without decorative bezel)-195 x 195 x 60,4 (with decorative bezel)			
WEIGHT	470gr.			
GUARANTEE	3 years (1 year for the battery)			

**Thank you for your trust in our products.
Olympia Electronics - European manufacturer.**

GENERAL

These devices are used indoors (ta 40°C) in places where emergency luminaires are needed. The luminaires GR-470 and GR-472 are suitable for corridors lighting and the GR-471 and GR-473 for open area lighting. Each device must be permanently connected to mains power supply. In normal operation the battery is charging. In case of a mains power supply failure the device will light the illumination led automatically in emergency mode. When the mains power supply is restored the device turns to normal operation.

INSTALLATION

To install the luminaire follow the installation instructions on page 2.

ATTENTION!!!

- Operations for installation, maintenance or testing must be done by authorized personnel only.
- The device must be connected to the mains power supply thru a fuse dependent by the total amount of the line's power load.
- It is suggested to check every month the indication LED for battery charging, and by placing the test card (A-1900) (page 5) an

operation test is initiated, to check the emergency circuit. The illumination source should light as long as the card is present. In the opposite condition contact the installer.

4. It is suggested to check every 6 months the minimum autonomous duration by disconnecting the mains power supply. Count the time that the luminaire lights and in case of less time than the minimum autonomous duration the battery must be replaced. If the measured time is considerably less than the minimum autonomous duration contact the installer.

In case of battery or light source replacement, these must be replaced by parts of the same type, by the manufacturer or by a competent person.

5. In case of inactive use for a period greater than 2 months, disconnect the battery by pulling out the battery's connector.

6. **It is not allowed to discard batteries in to common trash bins, they must be discarded only in battery recycling points. Do not incinerate.**



INSTALLATION INSTRUCTIONS

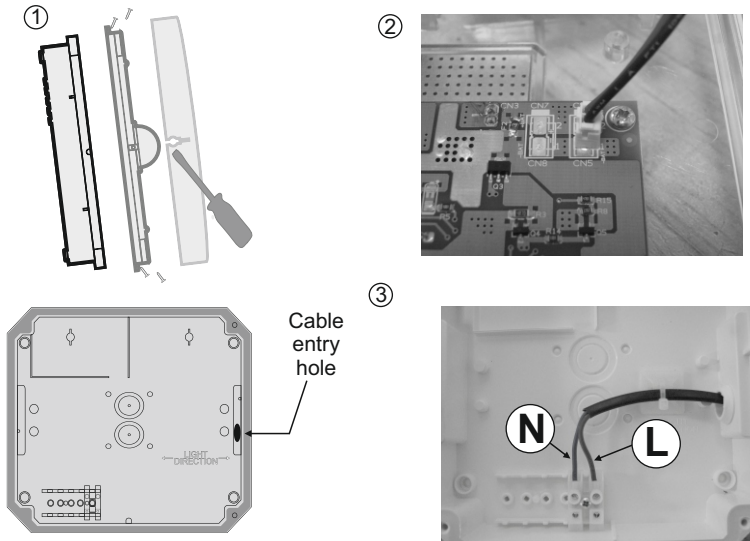

Initial installation

1. Detach the front cover by applying pressure using a flat blade screw driver. Next, unfasten the four retaining screws without removing them and remove the diffuser.
2. Install the battery connector to its corresponding connector on the main pcb.
3. Install the cable grommet in the open hole of the plastic base and open a hole in the center of the grommet using a small screw driver. Pass the power cable through the hole in the grommet (If required, open another cutout cable entry hole and install the second supplied cable grommet). Connect the cables as shown in the photograph. Use the supplied self adhesive pad and cable tie to anchor the cable.
4. Reinstall the diffuser and re-tighten the 4 screws in a diagonally manner with a torque of $0,9 \text{ N}^*\text{m}$.

NOTE!! After finishing the installation you must power the luminaire for at least 24 hours in order to completely charge the batteries. The rated autonomous duration can be achieved after this.

GR-470, GR-472

Corridor
lighting

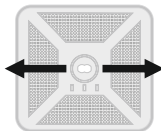

ATTENTION!!!
During installation follow this light direction.

GR-471, GR-473

Open
area
lighting



MOUNTING IN SUSPENDED CEILING

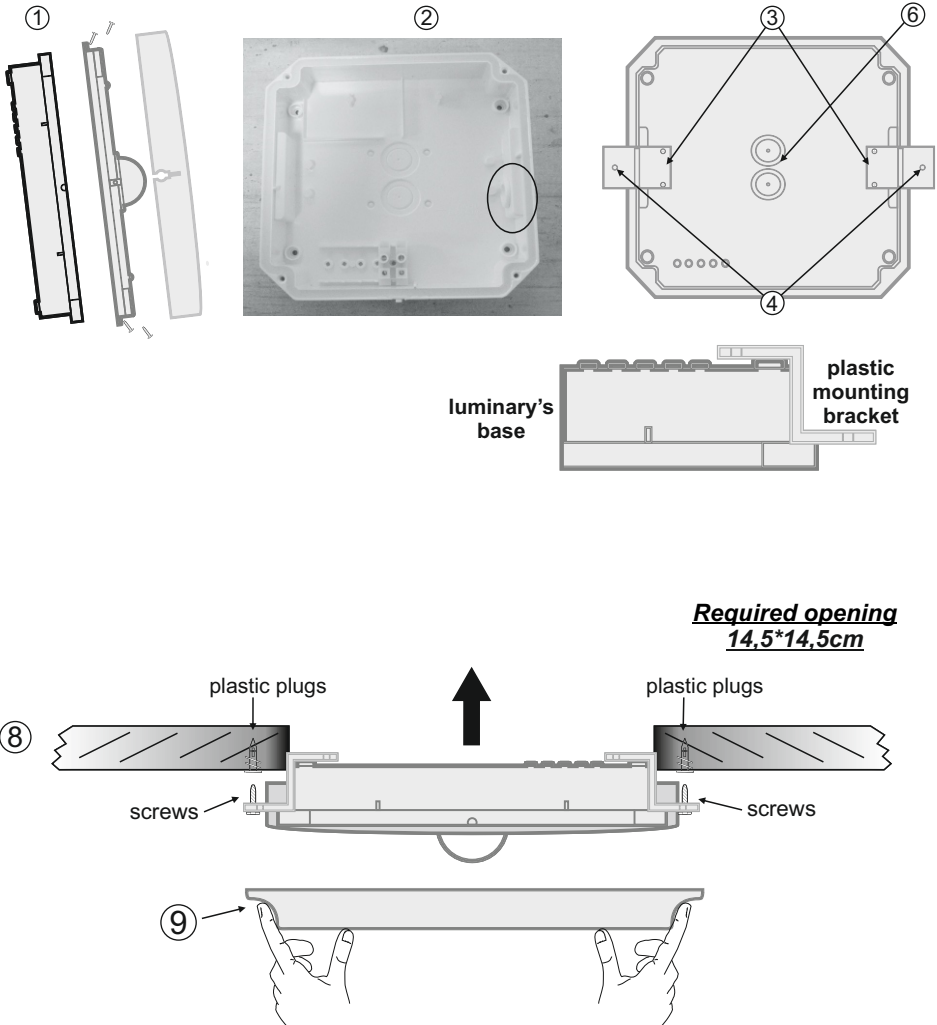

***Required opening
14,5*14,5cm***

1. Detach the front cover by applying pressure using a flat blade screw driver. Next, unfasten the four retaining screws (figure 1) without removing them and remove the diffuser.
2. Install the supplied cable grommet (figure 2).
3. Install the two plastic brackets with the four screws (figure 3).
4. Mark the positions of the mounting holes on the brackets.
5. Install the two supplied plaster board plugs by screwing them on the plaster board ceiling.
6. Open a cable entry cutout hole on the plastic base and follow step 3 in the "initial installation" section.
7. Re-install the front cover that was removed in step 1.
8. Use the supplied screws to fasten the luminaire to the plaster board plugs (figure 8) that were previously installed on the plaster board ceiling.
9. Finally, install the supplied decorative bezel (figure 9) and the notch on the bezel must be located on the left side of the luminaire (figure 10).

MOUNTING IN SUSPENDED CEILING

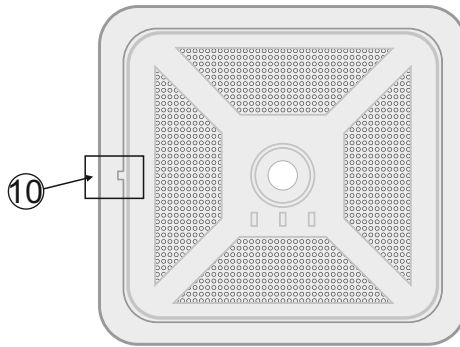

SURFACE MOUNTING

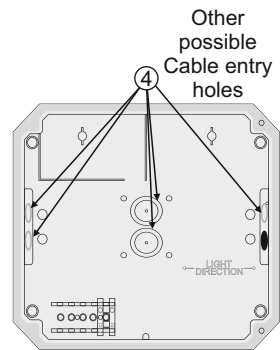
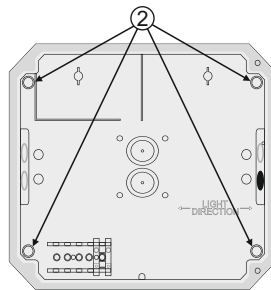
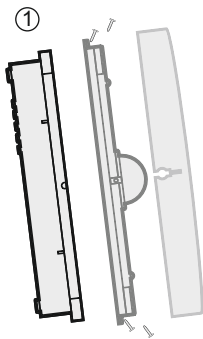

⑤

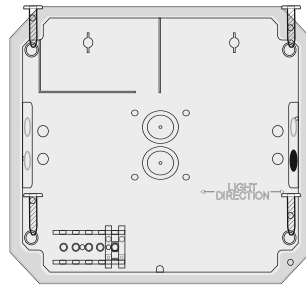

1. Detach the front cover by applying pressure using a flat blade screw driver. Next, unfasten the four retaining screws without removing them and remove the diffuser.
2. Use a drill with a 3,5mm bit to open the 4 mounting holes (figure 2) located in the plastic base..
3. Place the luminaire on the desired mounting location and mark and drill these 4 holes. Fit the supplied 4 plastic mounting plugs to these drilled holes on the mounting location.
4. If the cable entry hole is not suitable then use one of the supplied cables grommets to cover the holes and open another cable entry cut out hole (figure 3). Follow step 3 of the “ **initial installation procedure**”.
5. Mount the base to the desired location by using the supplied screws in each mounting hole (figure 4).
6. Re-install the cover that was removed in step 1.

LED MODULE CHARACTERISTICS

	GR-470	GR-471	GR-472	GR-473
Manufacturer	Olympia Electronics S.A.			
Model Number	0205183			
Voltage Range	5.6-6.6V DC			
Nominal Power	1W			
Connections	fixed connection between main pcb and led module			
Temperature (tc)	55 °C max. across the board			

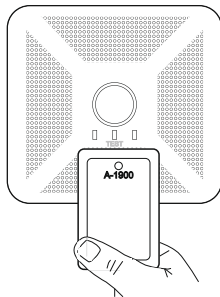

Manual TEST with the A-1900 Test card (not included and is available only on request). In order to test the device you must place the card in front of the indications TEST mark and remove it instantly for TEST.

NOTE: LED= Light Emitting Diode

LABELING EXPLANATION:

X: Self contained

0: Non maintained (*)

A: Including test device

***90:** 1.5 hour duration

180: 3 hours duration

(*) Non Maintained operation: The luminaire lights its illumination source, only in power supply's failure.

Maintained operation: The luminaire lights its illumination source, when it is powered by the



CAUTION : Do not view directly with bare eyes



The light source contained in this luminaire shall only be replaced by the manufacturer, or his agent, or a similar qualified person.

NOTE! The light source is non-user replaceable.

Battery replacement

It can be done only by a competent person and after the mains interruption.

1. Detach the front cover by applying pressure using a flat blade screw driver. Next, unfasten the four retaining screws without removing them and remove the diffusor.
3. Disconnect the connector and remove the old battery.
4. Connect the new battery with the same type (step 2 of the installation instructions) and place it in the position of the old one.
5. Replace the removed parts and power the device.

WARRANTY

Olympia Electronics guarantees the quality, condition and operation of the goods. The period of warranty is specified in the official catalogue of Olympia Electronics and also in the technical leaflet, which accompanies each product. This warranty ceases to exist if the buyer does not follow the technical instructions included in official documents given by Olympia Electronics or if the buyer modifies the goods provided or has any repairs or re-setting done by a third party, unless Olympia Electronics has fully agreed to them in writing. Products that have been damaged can be returned to the premises of our company for repair or replacement, as long as the warranty period is valid. Olympia Electronics reserves the right to repair or to replace the returned goods and to or not charge the buyer depending on the reason of defection. Olympia Electronics reserves the right to charge or not the buyer the transportation cost.

HEAD OFFICE

72nd km. O.N.R. Thessaloniki-Katerini
P.C. 60300 P.O. Box 06 Eginio Pierias Greece

www.olympia-electronics.gr
info@olympia-electronics.gr