



**KERN & Sohn GmbH**

Ziegelei 1

D-72336 Balingen

E-Mail: [info@kern-sohn.com](mailto:info@kern-sohn.com)

Phone: +49-[0]7433- 9933-0

Fax: +49-[0]7433-9933-149

Internet: [www.kern-sohn.com](http://www.kern-sohn.com)

## Operating manual Electronic Crane Scales

Logbook  
Regular maintenance and care

### KERN HCD

Version 1.0

2018-09

GB



HCD-BA-e-1810



# KERN HCD

Version 1.0 2018-09

## Operating instructions / logbook Electronic Crane Scales

### Contents

1.	Technical data	3
1.1	Dimensions (mm)	5
1.1.1	Scale	5
1.1.2	Hooks and Shackle	7
1.2	Type plate	8
2.	General Safety Instructions	9
2.1	Duties of the owner-operator	9
2.2	Organizational measures	9
2.3	Environmental conditions	10
2.4	Pay attention to the instructions in the Operation Manual	10
2.5	Proper use	10
2.6	Improper Use	10
2.7	Warranty	11
2.8	Safe working	11
2.9	Monitoring of Test Resources	11
2.10	Testing upon acceptance	11
2.11	Initial Commissioning	11
2.12	Shutdown and storage	11
3.	Operating elements	12
3.1	Remote control	13
3.2	Label	14
4.	Commissioning	15
4.1	Unpacking	15
4.2	Checking the original dimensions	16
4.3	Battery operation	16
4.4	Suspending the balance	17
5.	Operation	18
5.1	Safety instructions	18
5.2	Loading the crane scales	19
5.3	Turn on/off	22
5.4	Taring	22
5.5	Weighing	22
5.6	Switch-over weighing unit	23
5.7	Functions	23
6.	Menu	26
7.	Adjustment	27
8.	Maintenance, Repair, Cleaning and Disposal	28
8.1	Cleaning and Disposal	28
8.2	Regular maintenance and care	29
8.3	Checklist „Regular maintenance“, (see chapter 8.2)	30
9.	Enclosure	33
9.1	Checklist „Enhanced maintenance“ (General revision)	33
9.2	List „spare parts and repair of safety-relevant parts“	34

## 1. Technical data

<b>KERN</b>	<b>HCD 60K-2</b>	<b>HCD 100K-2</b>	<b>HCD 300K-1</b>
Item no./ Type	THCD 60K-2-A	THCD 100K-2-A	THCD 300K-1-A
Readability (d)	0.02 kg	0.05 kg	0.1 kg
Weighing range (max)	60 kg	150 kg	300 kg
Taring range (subtractive)	60 kg	150 kg	300 kg
Reproducibility	0.02 kg	0.05 kg	0.1 kg
Linearity	± 0.04 kg	± 0.1 kg	± 0.2 kg
Recommended adjustment weight, not added (class)	50 kg (M1)	100 kg (M1)	200 kg (M1)
Stabilization time	2 s		
Precision	0.2 % of max.		
Warm-up time	10 min		
Units	kg, lb, N		
Allowable ambient temperature	+5...+40 °C		
Relative humidity	0 to 80 %, non-condensing		
Battery (in series)	4 x 1.5V AA Operating time backlight on 37 h Operating time backlight off 100 h		
Rechargeable battery	Optional		
Input voltage Appliance	9V, 300 mA		
Input voltage Mains adapter	100V - 240V AC, 50/60 Hz		
Display	Digit height 28 mm		
Display housing Dimensions Width x Depth x Height, (mm)	150 x 79 x 97		
Housing material	Synthetic material		
Load hook material	Painted steel		
Net weight (kg)	0.85		
Remote control (standard equipment) wireless	Battery Size CR2025 (1 x 3V)		

<b>KERN</b>	<b>HCD 100K-2D</b>	<b>HCD 300K-2D</b>
Item no./ Type	THCD 100K-2D-A	THCD 300K-2D-A
Readability (d)	0.02 kg; 0.05 kg	0.05 kg; 0.1 kg
Weighing range (max)	60 kg; 150 kg	150 kg; 300 kg
Taring range (subtractive)	60 kg; 150 kg	150 kg; 300 kg
Reproducibility	0.02 kg; 0.05 kg	0.05 kg; 0.1 kg
Linearity	±0.04 kg; 0.1 kg	±0.1 kg; 0.2 kg
Recommended adjustment weight, not added (class)	100 kg (M1)	200 kg (M1)
Stabilization time	2 s	
Precision	0.2 % of max.	
Warm-up time	10 min	
Units	kg, lb, N	
Allowable ambient temperature	+5...+40 °C	
Relative humidity	0 to 80 %, non-condensing	
Battery (in series)	4 x 1.5V AA Operating time backlight on 37 h Operating time backlight off 100 h	
Rechargeable battery	Optional	
Input voltage Appliance	9V, 300 mA	
Input voltage Mains adapter	100V - 240V AC, 50/60 Hz	
Display	Digit height 28 mm	
Display housing Dimensions Width x Depth x Height, (mm)	150 x 79 x 97	
Housing material	Synthetic material	
Load hook material	Painted steel	
Net weight (kg)	0.85	
Remote control (standard equipment) wireless	Battery Size CR2025 (1 x 3V)	

## 1.1 Dimensions (mm)

### 1.1.1 Scale

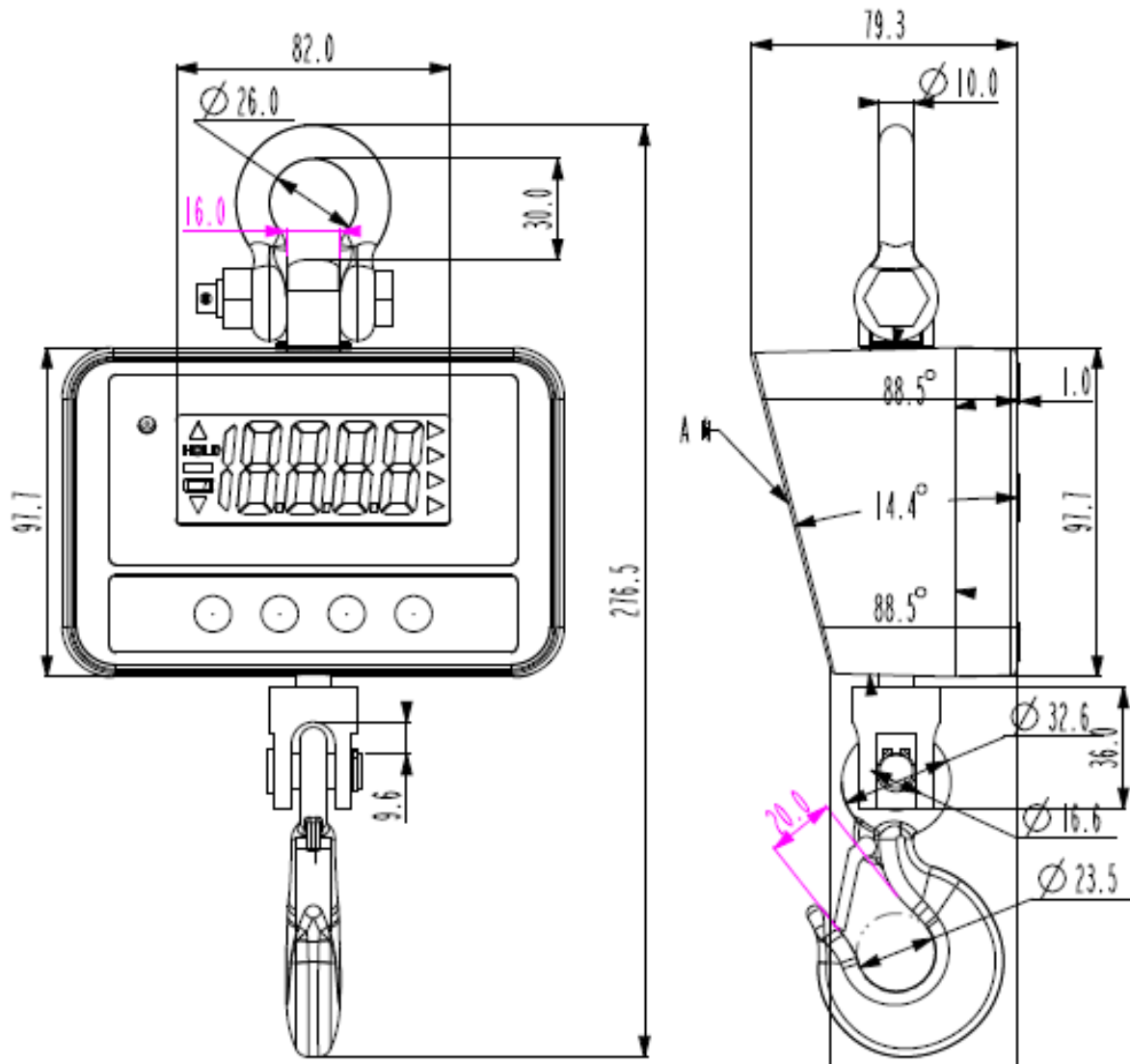

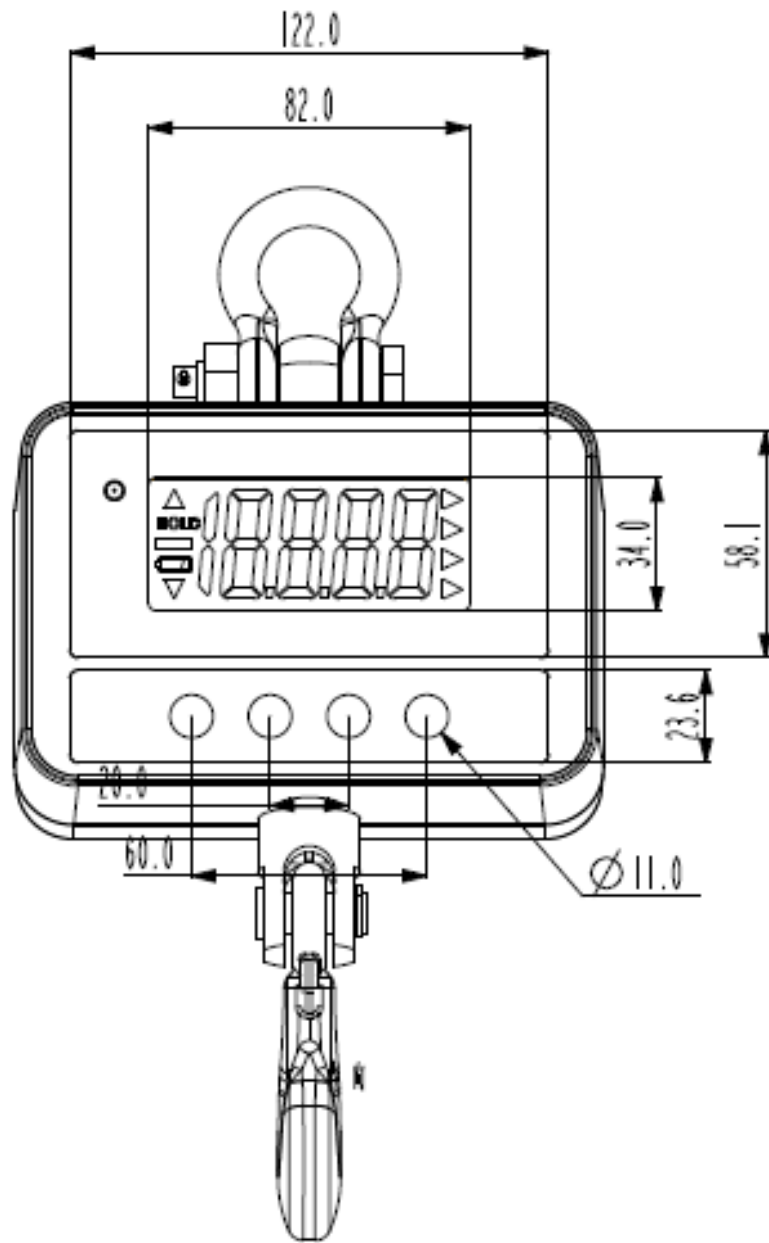

1.1.2 Hooks and Shackle

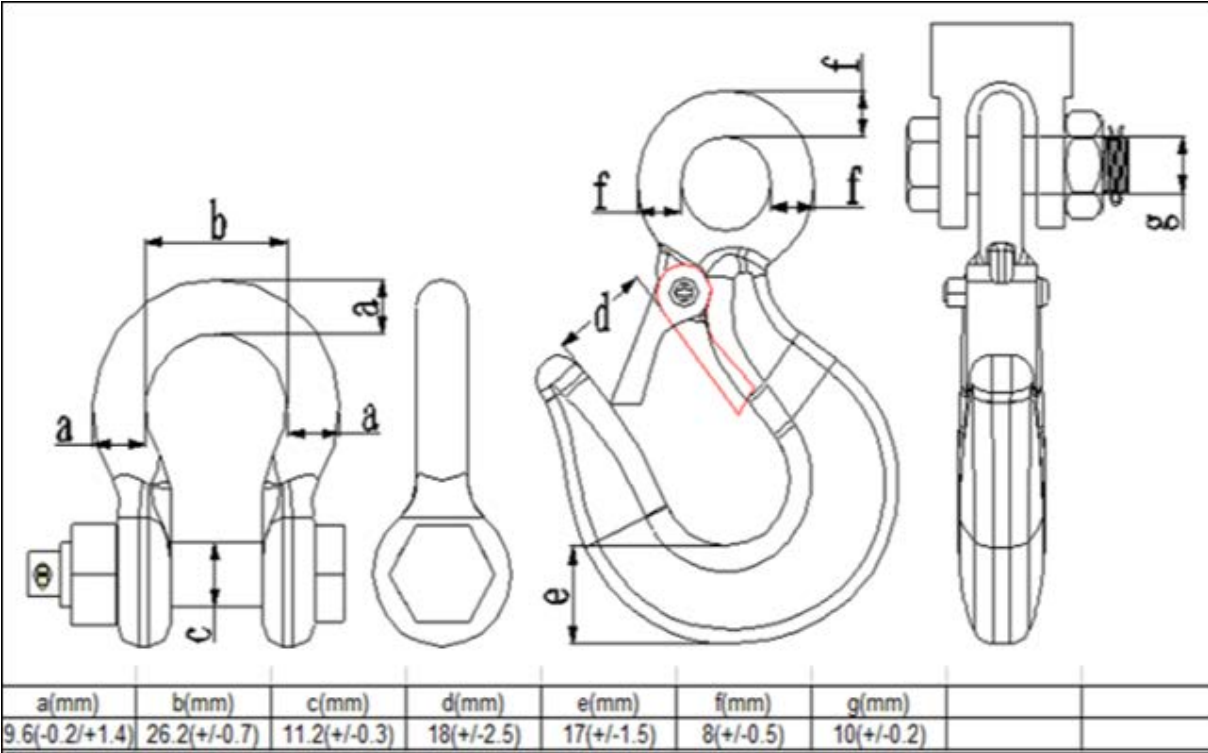

## 1.2 Type plate

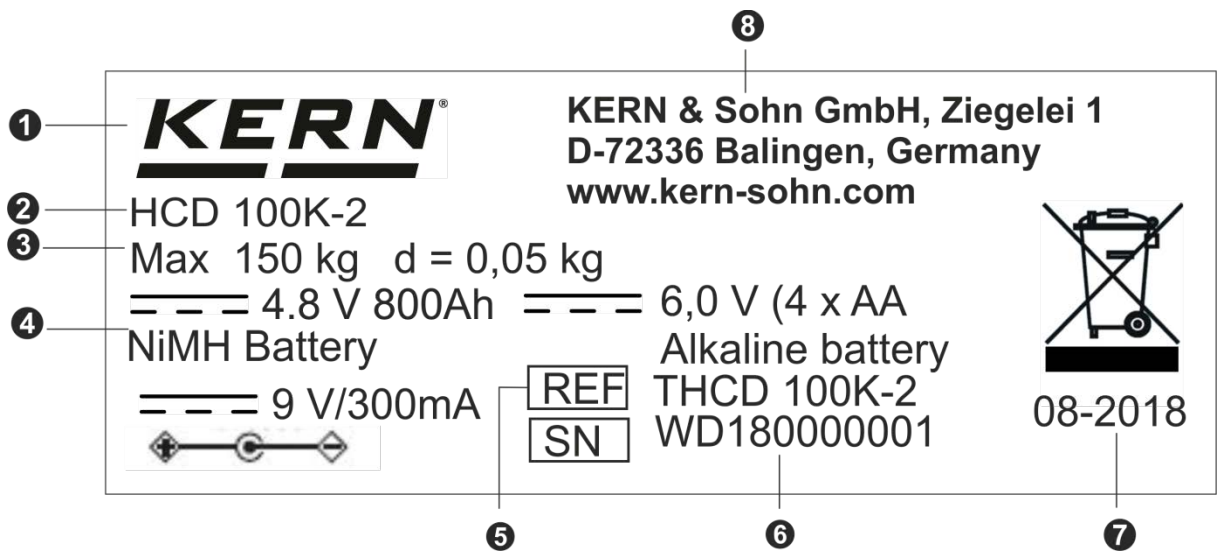

1	KERN Logo
2	Model designation
3	Weighing range [Max], Readability [d]
4	Data for power supply
5	Product No
6	Serial number
7	Disposal mark
8	Company address



## **2. General Safety Instructions**

### **2.1 Duties of the owner-operator**

**Follow national accident prevention regulations and all operator health and safety at work and operating regulations.**

- Observe all safety regulations of the crane manufacturer.
- The balance may only be used for the proposed purpose. Any type of use which is not specified in these operating instructions, will be considered as improper use. The customer is solely responsible for material damage and injury of persons resulting from an improper use, Messrs. KERN & Sohn will not be liable under any circumstance.  
Messrs. KERN & Sohn cannot be held liable, if the crane scales are modified or used improperly and if damage is resulting from such use.
- Inspect and service crane scales, crane and load suspension devices regularly (see chap. 8).
- Log the test result and keep it in the logbook.

### **2.2 Organizational measures**

- Only trained and instructed staff may operate the balance.
- Make sure that the operating instructions are kept nearby the operation site of the crane scales.
- Assembly, commissioning and maintenance should only be carried out by trained specialists.
- Repair of safety-relevant pieces may only be carried out by KERN or by service partners authorized by Messrs. KERN. (competence certificate or training).
- Use original spare parts only.
- All repairs and spare parts must be documented by the service partner (see list, chap. 9.2).
- All maintenance must be documented (see checklist chap. 8.3).
- Load suspending components may only be exchanged as a complete spare parts set. The dimensions of the new components must be noted (see checklist chapter 8.3).

## 2.3 Environmental conditions

- Never operate the crane scales in explosive environment. The serial version is not explosion protected.
- Operate the crane scales only under environmental conditions as specified in these operating instructions (especially in chapter 1 „Technical data“).
- Do not expose the crane scales to strong humidity. Non-permitted condensation (condensation of air humidity on the appliance) may occur if a cold appliance is taken to a considerably warmer environment. In this case, acclimatize the disconnected appliance for ca. 2 hours at room temperature.
- Do not operate the crane scales in corrosive environment.
- Protect the crane scales against high humidity, vapours and dust.
- Major display deviations (incorrect weighing results) may be experienced should electromagnetic fields (e.g. due to mobile phones or radio equipment), static electricity accumulations or instable power supply occur. Change location or remove source of interference.

## 2.4 Pay attention to the instructions in the Operation Manual



Carefully read this operation manual before setup and commissioning, even if you are already familiar with KERN balances.

## 2.5 Proper use

The balance you purchased is intended to determine the weighing value of material to be weighed. It is intended to be used as a “non-automatic” balance, i.e. the material to be weighed is suspended on the crane hook only vertically, manually, carefully and without jerks. As soon as a stable weighing value is reached the weighing value can be read.

- Use the crane scales only for lifting and weighing of freely movable loads.
- Danger of injury due to improper use. Not allowed are e.g.:
  - Exceeding the allowed nominal load of crane, crane scales or any type of load attachment devices
  - Conveying persons,
  - Pulling loads over an inclined surface,
  - Tearing-off, pulling or towing loads.
- Modifications or reconstructions of the crane scales or of the crane are not allowed.

## 2.6 Improper Use

Do not use balance for dynamic weighing. In the event that small quantities are removed or added to the material to be weighed, incorrect weighing results can be displayed due to the “stability compensation“. (Example: Slowly draining fluids from a container suspended on the balance.) Do not leave permanent load suspended on the balance. This may damage the measuring system as well as safety-relevant parts.

The balance may only be used according to the described conditions. Other areas of use must be released by KERN in writing.

## **2.7 Warranty**

Warranty claims shall be voided in case

- Our conditions in the operation manual are ignored
- The appliance is used outside the described uses
- The appliance is modified or opened
- Mechanical damage and damage caused by media, liquids,
- Natural wear and tear
- The appliance is improperly set up or incorrectly electrically connected
- The measuring system is overloaded

## **2.8 Safe working**

- Do not stand underneath suspended loads!
- Position the crane in a way that the load is lifted vertically.
- When working with the crane and crane scales wear personal safety equipment (helmet, safety shoes etc.).

## **2.9 Monitoring of Test Resources**

In the framework of quality assurance the measuring-related properties of the balance and, if applicable, the testing weight, must be checked regularly. The responsible user must define a suitable interval as well as type and scope of this test. Information is available on KERN's home page ([www.kern-sohn.com](http://www.kern-sohn.com)) with regard to the monitoring of balance test substances and the test weights required for this. In KERN's accredited DKD calibration laboratory test weights and balances may be calibrated (return to the national standard) fast and at moderate cost.

## **2.10 Testing upon acceptance**

When receiving the appliance, please check packaging immediately, and the appliance itself when unpacking for possible visible damage.

## **2.11 Initial Commissioning**

In order to obtain exact results with the electronic balances, your balance must have reached the operating temperature (see warming up time chap. 1).

During this warming up time the balance must be connected to the power supply (accumulator or battery).

The accuracy of the balance depends on the local acceleration of gravity.

Strictly observe hints in chapter Adjustment.

For checking original dimensions, see chap. 4.2

## **2.12 Shutdown and storage**

- Take off the crane scales from the crane and dismantle all load attachment devices from the crane scales.
- Do not store the crane scales at open air





### 3. Operating elements



#### Overview of display:





▶ <b>kg</b>	The current measuring unit is kilogram	
▶ <b>lb</b>	The current measuring unit is pound	
▶ <b>N</b>	The current measuring unit is Newton	
▲	Marks the weight value depending on the active setting H1-H6.	
	H1-H4:	Data-Hold function
	H5	Animal weighing function
	H6	Peak value function
🔋	Capacity of battery exhausted	
<b>HOLD</b>	Data hold function active	

### Keyboard overview:

Button	Description of function
	<ul style="list-style-type: none"> <li>• Turn on or off the balance</li> </ul>
	<ul style="list-style-type: none"> <li>• Record weight value (freeze)</li> </ul>
	<ul style="list-style-type: none"> <li>• Switch over weighing unit (kg→lb→N)</li> </ul>
	<ul style="list-style-type: none"> <li>• Taring</li> <li>• Zeroing</li> </ul>

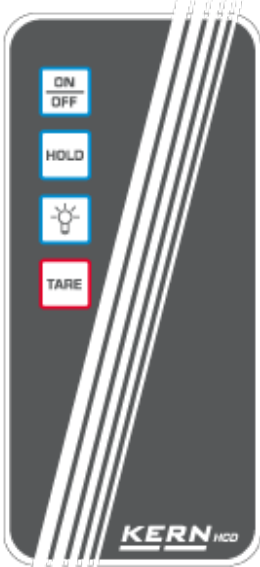
### 3.1 Remote control

The balance can be operated by the remote control like by a keyboard.

		<ul style="list-style-type: none"> <li>• Turn on or off the balance</li> </ul>
		<ul style="list-style-type: none"> <li>• Record weight value (freeze)</li> </ul>
		<ul style="list-style-type: none"> <li>• Switch on background illumination of the display for 30 s (menu setting &lt;bl→on&gt;)</li> </ul>
		<ul style="list-style-type: none"> <li>• Taring</li> <li>• Zeroing</li> </ul>

### 3.2 Label



- ⇒ Do not stand or go under suspended loads.
- ⇒ Do not use on building site.
- ⇒ Keep an eye on suspended loads.



(example)

- ⇒ Do not exceed the nominal load of crane, crane scales or any kind of load attachment devices at the crane scales.





- ⇒ The product conforms to the requirements of the German Equipment and Product Safety Act.

## 4. Commissioning

	<p> <b>Always observe chapter 2 „General Safety Instructions“!</b></p>
---	---

### 4.1 Unpacking

 <p><b>SAFETY INSTRUCTIONS</b> for protection against break</p>	<p><b>Once delivered and unpacked, crane scales will not be taken back.</b></p>
	<p>The crane scales have been sealed by Messrs. KERN.</p> <p>⇒ Shackles and hooks are sealed by KERN tape.</p> <p>⇒ The packaging is also sealed by adhesive tape.</p> <p> <b>Broken seal obliges to purchase.</b></p> <div data-bbox="858 869 1098 1106" style="text-align: center;"></div> <p>Fig.: Seal</p>
	<p>Thanks for your comprehension. Your KERN Quality assurance team</p>

Only use original packaging for returning.

- ⇒ Make sure that all parts are completely present.
- Crane scales
  - Remote control
  - Batteries (4 x 1,5V AA)
  - Operating instructions (logbook)

## 4.2 Checking the original dimensions

- ⇒ Enter the original dimensions shown on the production data sheet in the grey fields of the checklist chap. 8.3.
- ⇒ Check the original dimensions of the crane scales; for implementation see chap. 8.2 "Regular Maintenance"
- ⇒ Enter all data (date, tester, results) in the first line under "Inspection before first use" in the checklist (see chapter 8.3)

 <b>CAUTION</b>	If the dimensions of your first safety inspection do not match those of KERN, the balance must not be put into operation. In this case please contact a service partner authorised by Messrs. KERN.
---	---

## 4.3 Battery operation

If the batteries are empty, the battery icon on the LCD will flash. If the battery voltage is too low, the battery icon and "Lo" will flash for 10 seconds then the scale will switch off.

Press **ON/OFF**-button and replace the batteries.

Open battery compartment, replace batteries and close battery compartment again.

In order to save the battery, the balance switches automatically off after 4 minutes without weighing. This auto-off function can be deactivated in the menu.

When the suspended balance is out of operation for a longer period, remove the batteries.



#### 4.4 Suspending the balance

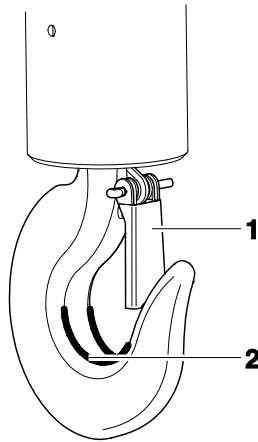

##### **Condition**





The crane needs a safety bracket (1) that the unloaded crane scales cannot fall down.

If the safety bracket is missing or damaged, please contact the crane manufacturer in order to receive a hook with this safety equipment.

- ⇒ Suspend the crane scales on the lower hook of a crane and close the safety bracket.  
The crane scale's upper eyelet should rest in the saddle (2).

## 5. Operation

### 5.1 Safety instructions

	 <p><b>Risk of injury due to falling loads!</b></p> <p><b>Danger</b></p>
  <p>(example)</p>	<ul style="list-style-type: none"> <li>⇒ Take great care when operating the crane and follow the general rules for crane operation.</li> <li>⇒ Check all parts (hook, eyelet, rings, rope slings, cables, chains etc.) for excessive wear or damage</li> <li>⇒ If faults can be seen on the safety bracket of the hook or if it is missing completely, the scales must not be used</li> <li>⇒ Work only with appropriate speed</li> <li>⇒ Always avoid vibrations and horizontal forces. Avoid any kind of shock, torsion and oscillating (e.g. caused by inclined suspending)</li> <li>⇒ Do not use the crane scales for transporting loads.</li>   <li>⇒ Do not stand or go under suspended loads.</li>   <li>⇒ Do not use on building site.</li>   <li>⇒ Keep an eye on suspended loads.</li>   <li>⇒ Do not exceed the nominal load of crane, crane scales or any kind of load attachment devices at the crane scales.</li>   <li>⇒ When weighing dangerous goods such as melted mass, radioactive material), observe the prescriptions for handling dangerous goods!</li> </ul>

## **5.2 Loading the crane scales**

For good weighing results observe the following, illustrations see next page:

- ⇒ Only use load attachment devices which guarantee a one-spot suspension and where the scales can be suspended freely.
- ⇒ Do not use too large load attachment devices which do not guarantee any one-spot suspension.
- ⇒ Do not use multiple suspensions.
- ⇒ Do not pull or push the load or the loaded balance.
- ⇒ Do not pull the hook horizontally.

### **Loading the balance**

1. Position the hook of the crane scales over the load.
2. Move downwards the crane scales until the load can be suspended on the hook of the balance. Reduce the speed when the respective height is going to be reached.
3. Suspend the load on the hook. Ensure that the safety bracket is closed. If the load is fixed by slings, ensure that the slings rest completely on the saddle of the balance hook.
4. Lift-off the load slowly.

When the load is fixed by slings, ensure that the load is well balanced on both sides and that the slings are correctly positioned

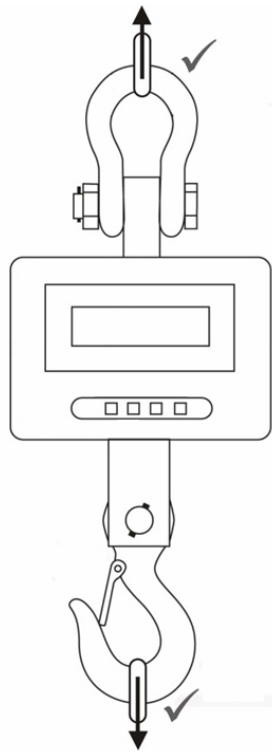

**Only use load attachment devices which guarantee a one-point suspension and where the scales can be suspended freely.**

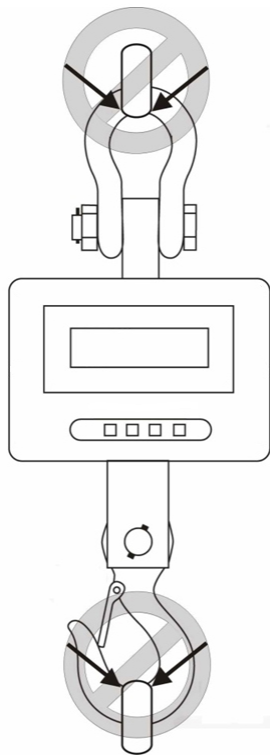

**Do not use too large load attachment devices which cannot guarantee a one-point suspension.**

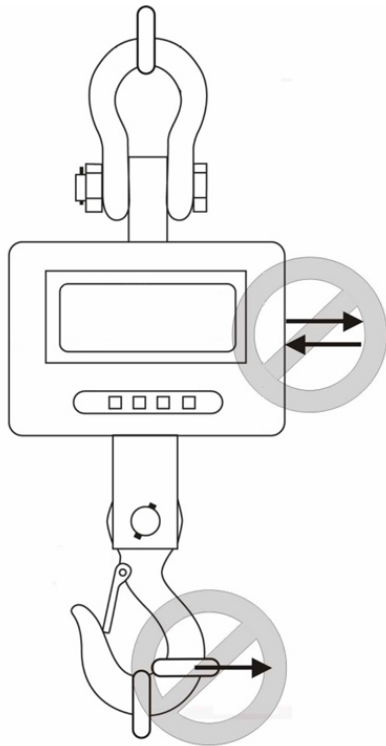

**Do not push or pull**

**Do not pull the hook horizontally**

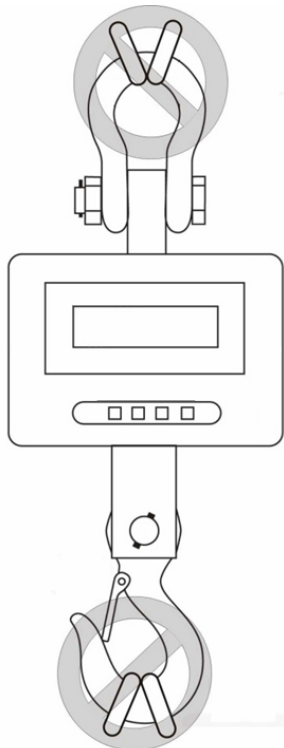

**Do not use multiple suspensions**

### 5.3 Turn on/off

#### Start-up

- ⇒ Press the **ON/OFF** button. The display lights up and the balance carries out a selftest. The selftest is completed when the weight value 0 appears on the display.

#### Switching Off

- ⇒ Press the **ON/OFF** button.

### 5.4 Taring

- ⇒ Suspend preload.  
Press the **TARE** button, the zero display appears. The weight of the container is now internally saved.



- ⇒ Weigh the material, the net weight will be indicated.
- ⇒ After removing the preload weight appears as negative display.
- ⇒ To delete the tare value, remove load from the suspended balance and press the **TARE** button.

### 5.5 Weighing

- ⇒ Load the suspended balance
- ⇒ Wait for stability display
- ⇒ Read weighing result

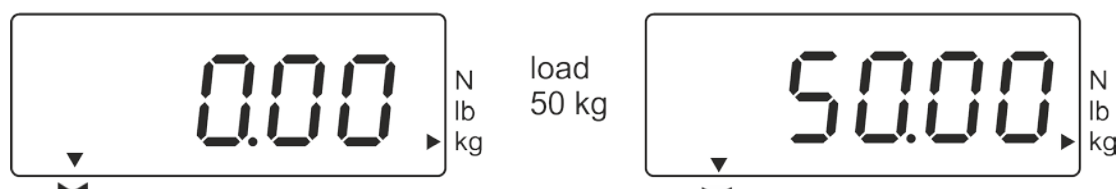

#### Overload warning

Overloading exceeding the stated maximum load (max) of the balance, minus a possibly existing tare load, must be strictly avoided. This could cause damage to the balance.

Exceeding the maximum load is indicated by the display „E“. Unload balance or reduce preload.

## 5.6 Switch-over weighing unit

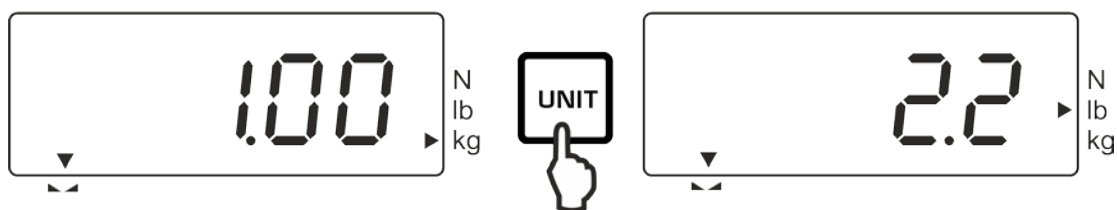

The next measuring unit will be displayed **kg**→**lb**→**N** after each press of the **UNIT** button. The ► indicator shows the active unit.

## 5.7 Functions

With help of the **Hold**-button the following functions can be activated:

Adjustment	Function	
H1	Data-Hold function 1 Weighing value frozen for 5 sec. after pressing the <b>Hold</b> -button	
H2	Data-Hold function 2 The weighing value will be frozen after pressing the <b>Hold</b> -button until another button is actuated	
H3	Data-Hold function 3 The weighing value is automatically frozen for 5 sec.	
H4	Data-Hold function 4 The weighing value is automatically frozen after reaching a stable value until a button will be actuated	
H5	Animal weighing function	☞ see chap. 5.7.2
H6	Peak value function	☞ see chap. 5.7.3

### 5.7.1 Data-Hold function

- ⇒ Switch on the balance, keep the **HOLD**-button pressed until the current setting „Hx“ (H1 – H6) appears.
- ⇒ Press **ON/OFF** button repeatedly until the desired setting „H1-H4“ is displayed.
- ⇒ Confirm setting with the **HOLD** button.
- ⇒ Suspend the material to be weighed
- ⇒ The weight value is fixed and displayed depending on the setting (H1 – H4) (see chap. 5.7), symbolised by the [▲] top left.

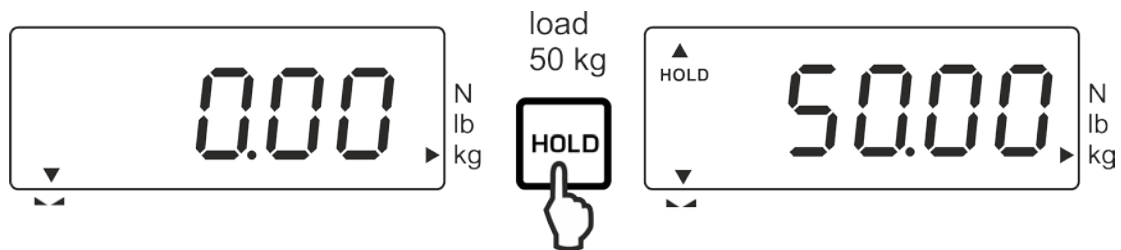

### 5.7.2 Animal weighing function

This function is suitable for busy weighing procedures. The result is a mean value formed by 16 weighing values which is found out within 3 seconds.

- ⇒ Switch on the balance, keep the **HOLD**-button pressed until the current setting „Hx“ (H1 – H6) appears.
- ⇒ Press **ON/OFF** button repeatedly until the setting „H5“ is displayed.
- ⇒ Confirm setting with the **HOLD** button.
- ⇒ Suspend the material to be weighed
- ⇒ Press the **HOLD**-button, the display counts reverse from 3 -1.  
The calculated mean value is indicated, symbolised by the [▲] top left.
- ⇒ Before further measurements press first the **TARE**-button.



### 5.7.3 Peak value function

This function displays the highest load value (peak value) of a weighing.  
Measuring frequency: 200ms

#### Attention:



**Never exceed the maximum permitted load of the peak value on the balance (!!Danger of breaking!!).**

- ⇒ Switch on the balance, keep the **HOLD**-button pressed until the current setting „Hx“ (H1 – H6) appears.
- ⇒ Press **ON/OFF** button repeatedly until the setting „**H6**“ is displayed.
- ⇒ Use the **HOLD**-button to confirm your selection
- ⇒ Suspend the material to be weighed
- ⇒ The peak value appears for a short time, symbolised by the [▲] top left. The balance returns automatically to zero and is ready for further measurement.

## 6. Menu

- ⇒ When the balance is switched off, press the **HOLD**-button and keep it pressed
- ⇒ Do not release the **HOLD**-button. Press also the **ON/OFF** -button and keep it pressed
- ⇒ Keep the **ON/OFF**-button pressed, however release the **HOLD**-button
- ⇒ Press **HOLD**-button anew
- ⇒ Keep both buttons pressed until in the display “**tr**” appears
- ⇒ Release both buttons. The balance is situated in the menu.
- ⇒ Using the **ON/OFF**-button you can select between the following functions:

Function	Settings	Description
<b>tr</b> Zero tracking	on	Auto Zero
	off	
<b>AF</b> Auto off	off 5	Automatic switch-off function after 3, 5, 10, 20 or 30 min.
	off 10	
	off 20	
	off 30	
<b>bL</b> Background illumination of the display	on	Background illumination on
	off	Background illumination off
	Ch	The background illumination will be switched off automatically 10 sec after having reached a stable weighing value.
<b>rST</b>	YES	Reset to factory setting
	NO	

- ⇒ Press the **HOLD** button to confirm the selected function
- ⇒ In the display appears the current setting „**ON**“ or „**OFF**“. With help of the **ON/OFF** -button you can select between „**ON**“ or „**OFF**“. Confirm your selection with the **HOLD**-button. After a short period the balance returns automatically to weighing mode.

## 7. Adjustment

As the acceleration value due to gravity is not the same at every location on earth, each balance must be coordinated - in compliance with the underlying physical weighing principle - to the existing acceleration due to gravity at its place of location (only if the balance has not already been adjusted to the location in the factory). This adjustment process must be carried out for the first commissioning, after each change of location as well as in case of fluctuating environment temperature. To receive accurate measuring values it is also recommended to adjust the balance periodically in weighing operation.

Observe stable environmental conditions. A warming up time of approx. 1 minute is recommended for stabilization.

Prepare adjustment weight, for details see chap. 1 „Technical data“.

⇒ Switch on balance



⇒ Press **Unit** button and hold down (approx. 3 secs) until „CAL“ is displayed.



⇒ After that the weight value of the required adjustment weight (see chap. 1) is displayed.



⇒ Attach adjustment weight, a short time later „F“ will appear.

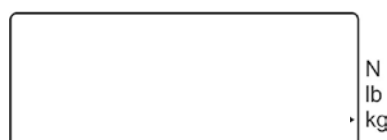

⇒ After adjustment the balance turns itself off again automatically.  
In case of an adjustment error or wrong adjustment weight „E“ is displayed, repeat the adjustment process

## 8. Maintenance, Repair, Cleaning and Disposal

 <p><b>Danger</b></p>	<p><b>Risk of injury and risk of material damage!</b> <b>The crane scales is part of a hoisting device!</b> <b>For a safe operation please observe the following:</b></p> <ul style="list-style-type: none"><li>⇒ Have carried out a regular maintenance by trained specialized staff</li><li>⇒ Carry out regular maintenance and care, see chapter 8.2.</li><li>⇒ Have the parts exchanged only by trained specialized staff.</li><li>⇒ If there arose discrepancies with the safety checklist, the balance must not more be put into operation.</li><li>⇒ Do not repair the crane scales by yourself. Repair may only be carried out by service partners authorized by Messrs. KERN.</li></ul>
--	--

### 8.1 Cleaning and Disposal

 <p><b>CAUTION</b></p>	<p><b>Damage on the crane scales!</b></p> <ul style="list-style-type: none"><li>⇒ Do not use any industrial solutions or chemicals</li></ul>
--	--

- ⇒ Clean the keyboard and the display with a soft cloth soaked in mild window cleaning agent.
- ⇒ Disposal of packaging and appliance must be carried out by operator according to valid national or regional law of the location where the appliance is used.

## 8.2 Regular maintenance and care

- ▲ The regular 3-month maintenance may only be carried out by an expert with competent knowledge of working with crane scales. Thereby the national regulations for prevention of accidents as well as the working, operation and safety regulations of the owner-operator.
- ▲ To check the dimensions only use suitable test devices.
- ▲ The regular 12-month maintenance must only be carried out by trained specialized staff (KERN customer service).
- ▲ The results of the maintenance must be written down in the checklist (chap. 8.3).
- ▲ The additional results of the extended maintenance have to be entered in the checklist (chapter 9.1).
- ▲ The replaced spare parts also must be entered, (chapter 9.2)

### Regular maintenance:

<p>Initial start-up, every <b>3 months</b> or definitely after <b>12500 weighings</b></p>	<ul style="list-style-type: none"> <li>▪ Check all dimensions, see checklist chap. 8.3</li> <li>▪ Check the shackle or the eyelet for wear and tear, such as e.g. plastic deformation, mechanical damage (unevenness), notches, striation, cracks, corrosion, thread damage and torsions.</li> <li>▪ Check the application of the safety bracket on the hook, moreover check for fault and correct function</li> <li>▪ For balances of big construction size: Check that the split pin and the nut on the shackle are not loose</li> </ul> <p>If a dimension exceeds the admitted deviation from the original dimension (see checklist, chap. 8.3) or if other discrepancies have been found, the balance must be repaired at once by trained specialized staff (KERN customer service). Never do repair it by yourself! Take balance out of operation immediately!</p> <p>All repairs and spare parts must be documented by the service partner (see list, chap. 9.2).</p>
<p>Every <b>12 months</b> or in any case after <b>50 000 weighings</b></p>	<ul style="list-style-type: none"> <li>▪ If the enhanced maintenance has to be carried out by trained staff (KERN customer service). At this general revision all load carrying parts must be checked for gaps with magnetic powder</li> </ul>
<p>Every <b>5 years</b> or anyway after <b>250000 weighings</b></p>	<ul style="list-style-type: none"> <li>▪ All load carrying parts have to be exchanged by trained specialized staff (KERN customer service).</li> </ul>
<p>Every <b>10 years</b> or anyway after <b>500 000 weighings</b></p>	<ul style="list-style-type: none"> <li>▪ Replace the crane scale entirely</li> </ul>

### Hint

During the revision watch out for wear and tear according to the following drawings (chap. 8.3).

### 8.3 Checklist „Regular maintenance“, (see chapter 8.2)

Original dimensions crane scales, serial no.: ..... Capacity .....											
<b>Shackle</b>					<b>Hooks</b>						
a (mm)	b (mm)	c (mm)	Wear and tear	Split pin&Nut	d (mm)	e (mm)	f (mm)	g (mm)	Angle $\alpha$ (°)	Wear and tear	Safety bracket
Date .....					Tester .....						

	Shackles					Hooks							Date	Tester
	a	b	c	Wear and tear (see grey fields)	Split pin & Nut	d	e	f	g	Angle $\alpha$	Wear and tear (see grey fields)	Safety bracket		
Max. admitted variation	5 %	0 %	5 %	No deformation or cracks	tight	10 %	5 %	5 %	5 %	10 °	No deformation or cracks	Perfect working order		
Revision prior to first use														
3 months/ 12 500 x														
6 months/ 25 000 x														
9 months/ 37 500 x														
<b>12 months/ 50 000 x</b>														
15 months/ 62 500 x														
18 months/ 75 000 x														
21 months/ 87 500 x														

	Shackles					Hooks							Date	Tester
	a	b	c	Wear and tear (see grey fields)	Split pin & Nut	d	e	f	g	Angle $\alpha$	Wear and tear (see grey fields)	Safety bracket		
Max. admitted variation	5 %	0 %	5 %	<b>No deformation or cracks</b>	tight	<b>10 %</b>	<b>5 %</b>	<b>5 %</b>	<b>5 %</b>	<b>10 °</b>	<b>No deformation or cracks</b>	<b>Perfect working order</b>		
<b>24 months/100 000 x</b>														
27 months/112 500 x														
30 months/125 000 x														
33 months/137 500 x														
<b>36 months/150 000 x</b>														
39 months/162 500 x														
42 months/175 000 x														
45 months/187 500 x														
<b>48 months/200 000</b>														
51 months/212 500 x														
54 months/225 000 x														
57 months/237 500 x														
<b>60 months/250 000x</b>	<b>➔ All load carrying parts have to be exchanged by a service partner authorised by KERN.</b>													

**bold letters** = this maintenance work has to be carried out by a service partner authorized by KERN.

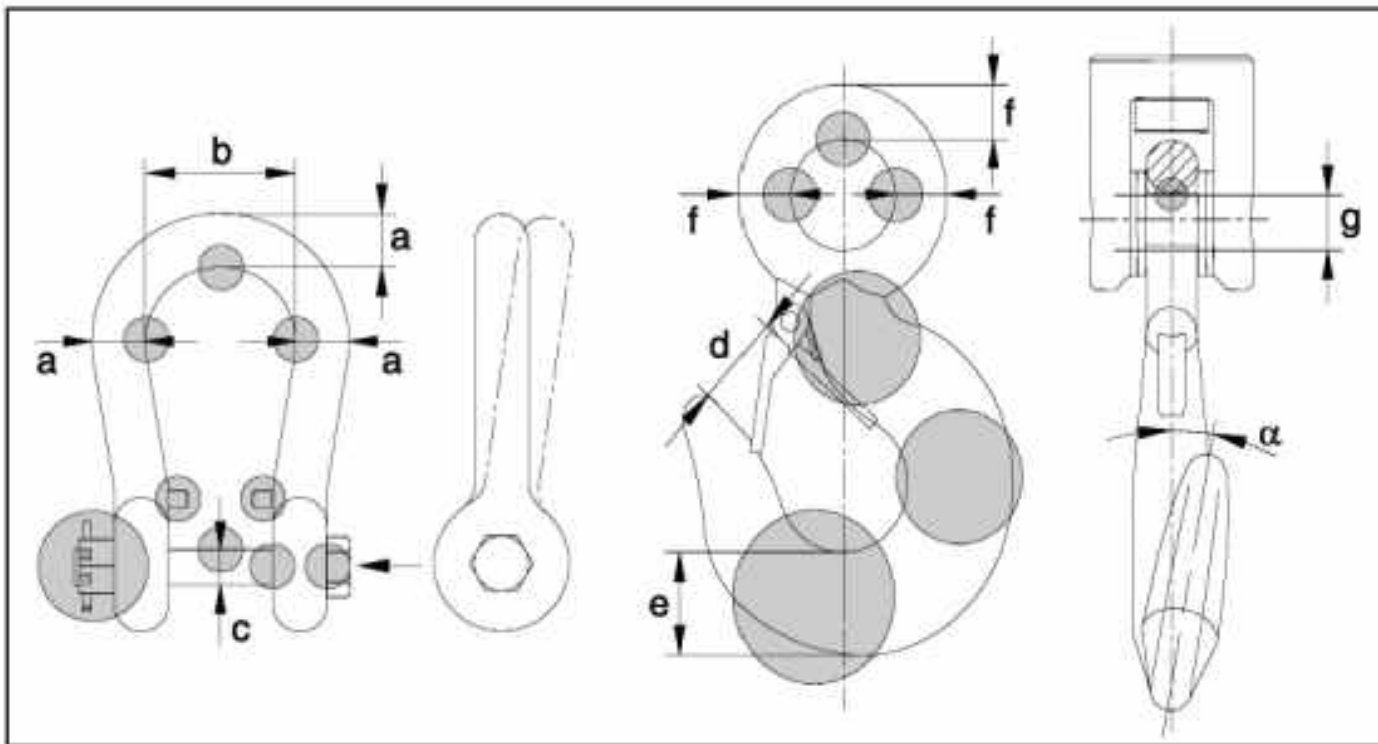



## 9. Enclosure

### 9.1 Checklist „Enhanced maintenance“ (General revision)

The enhanced maintenance has to be carried out by a service partner authorized by KERN.

Crane scales		Model ..... Serial no. ....					
Interval	Magnetic powder test for cracks	Hooks	Shackle	Screwed connections	Date	Name	Signature
12 months/50 000 x							
24 months/100 000 x							
36 months/150 000 x							
48 months/200 000 x							
60 months/250 000 x							
72 months/300 000 x							
84 months/350 000 x							
96 months/400 000 x							
108 months/450 000 x							
120 months/500 000x	➔ Replace crane scale entirely						

## 9.2 List „spare parts and repair of safety-relevant parts“

Repair has to be carried out by a service partner authorized by KERN.

<b>Crane scales</b>	Model ..... Serial no. ....			
<b>Part</b>	<b>Action</b>	<b>Date</b>	<b>Name</b>	<b>Signature</b>



