

**DEWALT**®

**XR LI-ION**

**[www.DEWALT.com](http://www.DEWALT.com)**

**DCGG571**



Fig. A

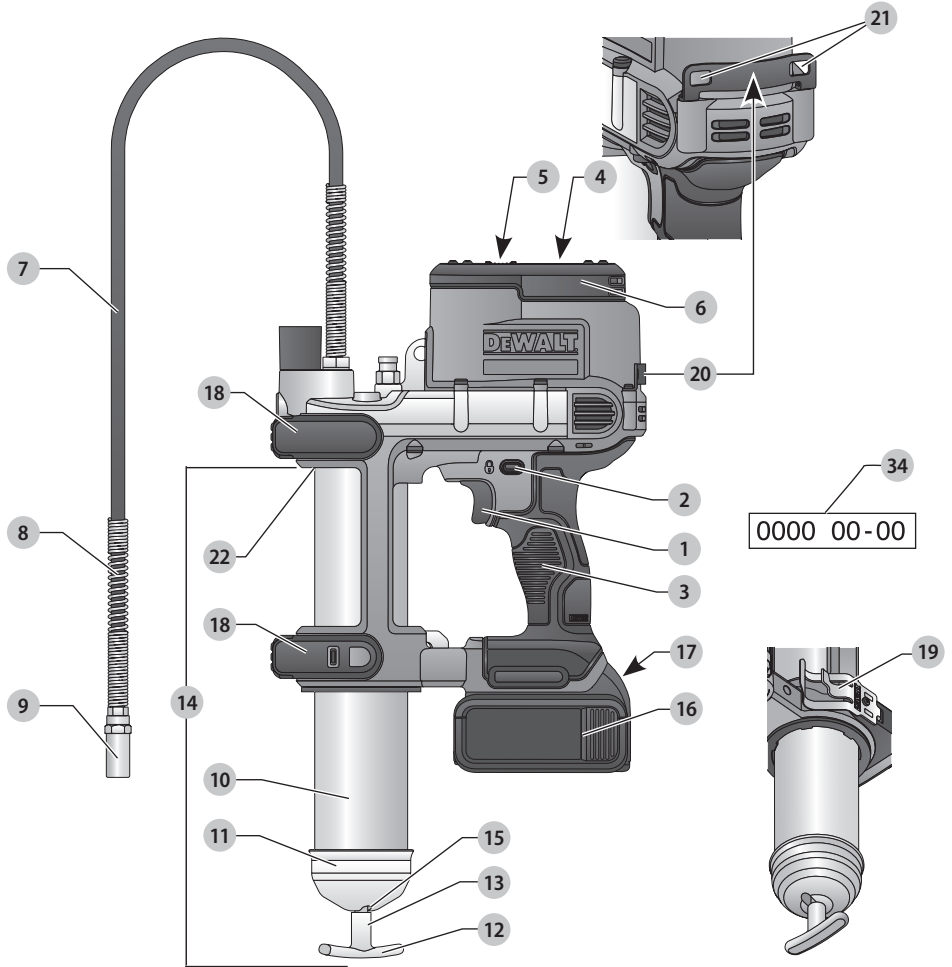

Fig. B

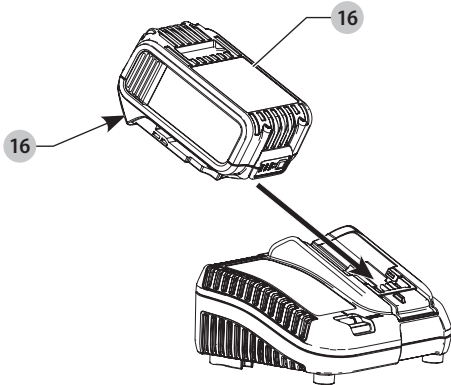

Fig. C

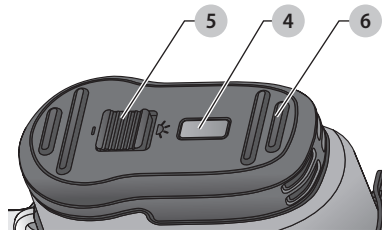

Fig. D

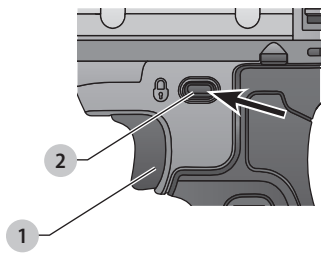

Fig. E

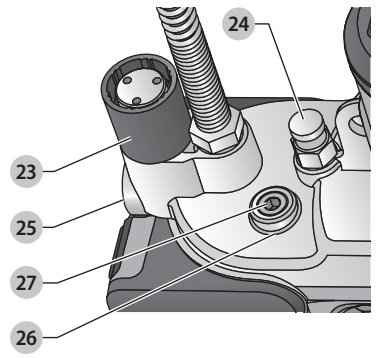

Fig. F

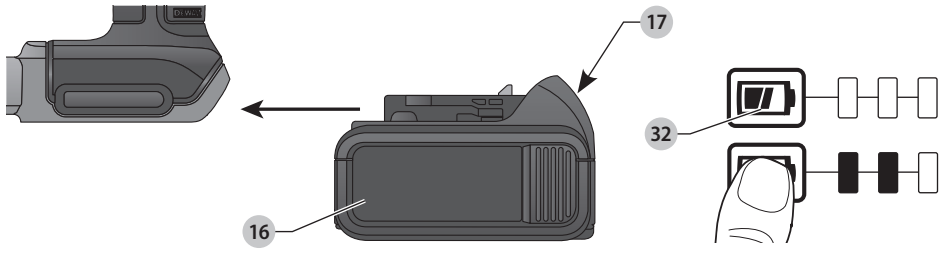

Fig. G

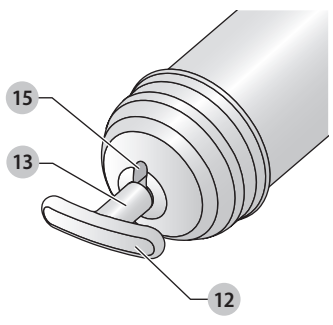

Fig. H

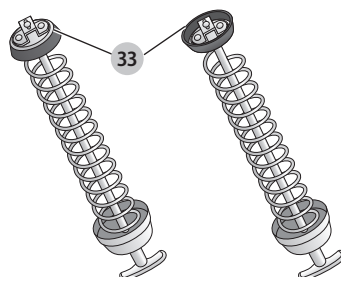

Fig. I

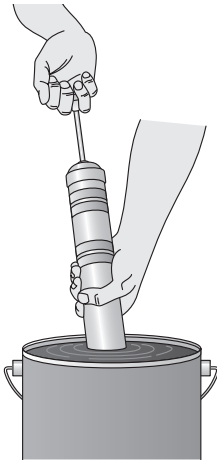

Fig. J

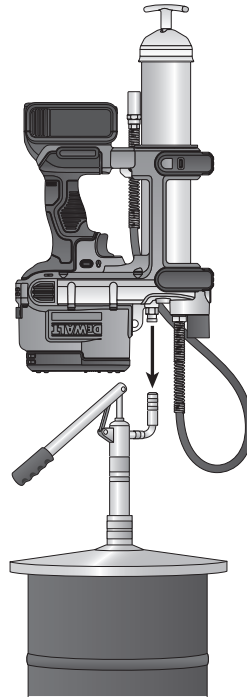

Fig. K

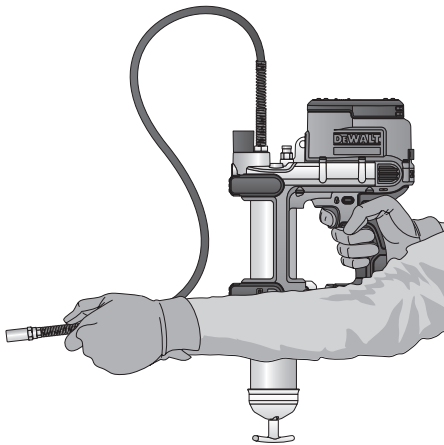

Fig. L

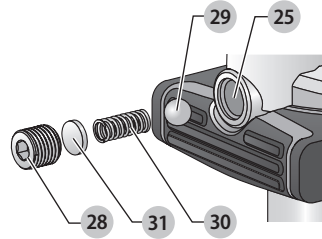
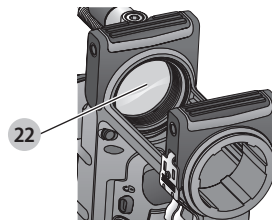

Fig. M



# CORDLESS GREASE GUN

## DCGG571

### Congratulations!

You have chosen a DEWALT tool. Years of experience, thorough product development and innovation make DEWALT one of the most reliable partners for professional power tool users.

### Technical Data

		DCGG571
Voltage	V <sub>DC</sub>	18
Type		1
Battery Type		Li-Ion
Output pressure	MPa	69 (690 bar)
Flow rate	ml per min	147.87
Grease type		Up to NLGI #2
Grease capacity		
Bulk	g	453
Cartridge	g	400
Hose length	cm	107
Weight (without battery pack)	kg	3.63
Noise values and/or vibration values (tri-ax vector sum) according to EN60745:		
L <sub>PA</sub> (emission sound pressure level)	dB(A)	76
L <sub>WA</sub> (sound power level)	dB(A)	87
K (uncertainty for the given sound level)	dB(A)	3
Vibration emission value a <sub>h</sub> =		
	m/s <sup>2</sup>	< 2.5
Uncertainty K =		
	m/s <sup>2</sup>	1.5

The vibration and/or noise emission level given in this information sheet has been measured in accordance with a standardised test given in EN60745 and may be used to compare one tool with another. It may be used for a preliminary assessment of exposure.

**WARNING:** The declared vibration and/or noise emission level represents the main applications of the tool. However if the tool is used for different applications, with different accessories or poorly maintained, the vibration and/or noise emission may differ. This may significantly increase the exposure level over the total working period.

An estimation of the level of exposure to vibration and/or noise should also take into account the times when the tool is switched off or when it is running but not actually doing the job. This may significantly reduce the exposure level over the total working period.

Identify additional safety measures to protect the operator from the effects of vibration and/or noise such as: maintain the tool and the accessories, keep the hands warm (relevant for vibration), organisation of work patterns.

### EC-Declaration of Conformity

#### Machinery Directive



#### Cordless Grease Gun DCGG571

DEWALT declares that these products described under **Technical Data** are in compliance with: 2006/42/EC, EN60745-1:2009 +A11:2010.

These products also comply with Directive 2014/30/EU and 2011/65/EU. For more information, please contact DEWALT at the following address or refer to the back of the manual.

The undersigned is responsible for compilation of the technical file and makes this declaration on behalf of DEWALT.

Markus Rompel  
Vice President of Engineering, PTE-Europe  
DEWALT, Richard-Klinger-Straße 11,  
D-65510, Idstein, Germany  
18.08.16



**WARNING:** To reduce the risk of injury, read the instruction manual.

### Definitions: Safety Guidelines

The definitions below describe the level of severity for each signal word. Please read the manual and pay attention to these symbols.



**DANGER:** Indicates an imminently hazardous situation which, if not avoided, **will** result in **death or serious injury**.



**WARNING:** Indicates a potentially hazardous situation which, if not avoided, **could** result in **death or serious injury**.



**CAUTION:** Indicates a potentially hazardous situation which, if not avoided, **may** result in **minor or moderate injury**.

**NOTICE:** Indicates a practice **not related to personal injury** which, if not avoided, **may** result in **property damage**.



Denotes risk of electric shock.



Denotes risk of fire.

Batteries				Chargers/Charge Times (Minutes)							
Cat #	V <sub>DC</sub>	Ah	Weight (kg)	DCB104	DCB107	DCB112	DCB113	DCB115	DCB118	DCB132	DCB119
DCB546	18/54	6.0/2.0	1.05	60	270	170	140	90	60	90	X
DCB547	18/54	9.0/3.0	1.46	75*	420	270	220	135*	75*	135*	X
DCB548	18/54	12.0/4.0	1.44	120	540	350	300	180	120	180	X
DCB181	18	1.5	0.35	22	70	45	35	22	22	22	45
DCB182	18	4.0	0.61	60/40**	185	120	100	60	60/40**	60	120
DCB183/B	18	2.0	0.40	30	90	60	50	30	30	30	60
DCB184/B	18	5.0	0.62	75/50**	240	150	120	75	75/50**	75	150
DCB185	18	1.3	0.35	22	60	40	30	22	22	22	X
DCB187	18	3.0	0.54	45	140	90	70	45	45	45	90
DCB189	18	4.0	0.54	60	185	120	100	60	60	60	120

\*Date code 201911475B or later

\*\*Date code 201536 or later

## GENERAL POWER TOOL SAFETY WARNINGS



**WARNING:** Read all safety warnings, instructions, illustrations and specifications provided with this power tool. Failure to follow all instructions listed below may result in electric shock, fire and/or serious injury.

### SAVE ALL WARNINGS AND INSTRUCTIONS FOR FUTURE REFERENCE.

The term "power tool" in the warnings refers to your mains-operated (corded) power tool or battery-operated (cordless) power tool.

#### 1) Work Area Safety

- Keep work area clean and well lit.** Cluttered or dark areas invite accidents.
- Do not operate power tools in explosive atmospheres, such as in the presence of flammable liquids, gases or dust.** Power tools create sparks which may ignite the dust or fumes.
- Keep children and bystanders away while operating a power tool.** Distractions can cause you to lose control.

#### 2) Electrical Safety

- Power tool plugs must match the outlet. Never modify the plug in any way. Do not use any adapter plugs with earthed (grounded) power tools.** Unmodified plugs and matching outlets will reduce risk of electric shock.
- Avoid body contact with earthed or grounded surfaces such as pipes, radiators, ranges and refrigerators.** There is an increased risk of electric shock if your body is earthed or grounded.
- Do not expose power tools to rain or wet conditions.** Water entering a power tool will increase the risk of electric shock.
- Do not abuse the cord. Never use the cord for carrying, pulling or unplugging the power tool. Keep cord away from heat, oil, sharp edges or moving parts.** Damaged or entangled cords increase the risk of electric shock.

- When operating a power tool outdoors, use an extension cord suitable for outdoor use.** Use of a cord suitable for outdoor use reduces the risk of electric shock.
- If operating a power tool in a damp location is unavoidable, use a residual current device (RCD) protected supply.** Use of an RCD reduces the risk of electric shock.

#### 3) Personal Safety

- Stay alert, watch what you are doing and use common sense when operating a power tool. Do not use a power tool while you are tired or under the influence of drugs, alcohol or medication.** A moment of inattention while operating power tools may result in serious personal injury.
- Use personal protective equipment. Always wear eye protection.** Protective equipment such as dust mask, non-skid safety shoes, hard hat or hearing protection used for appropriate conditions will reduce personal injuries.
- Prevent unintentional starting. Ensure the switch is in the off-position before connecting to power source and/or battery pack, picking up or carrying the tool.** Carrying power tools with your finger on the switch or energising power tools that have the switch on invites accidents.
- Remove any adjusting key or wrench before turning the power tool on.** A wrench or a key left attached to a rotating part of the power tool may result in personal injury.
- Do not overreach. Keep proper footing and balance at all times.** This enables better control of the power tool in unexpected situations.
- Dress properly. Do not wear loose clothing or jewellery. Keep your hair and clothing away from moving parts.** Loose clothes, jewellery or long hair can be caught in moving parts.
- If devices are provided for the connection of dust extraction and collection facilities, ensure these are connected and properly used.** Use of dust collection can reduce dust-related hazards.

- h) **Do not let familiarity gained from frequent use of tools allow you to become complacent and ignore tool safety principles.** A careless action can cause severe injury within a fraction of a second.

#### 4) Power Tool Use and Care

- a) **Do not force the power tool. Use the correct power tool for your application.** The correct power tool will do the job better and safer at the rate for which it was designed.
- b) **Do not use the power tool if the switch does not turn it on and off.** Any power tool that cannot be controlled with the switch is dangerous and must be repaired.
- c) **Disconnect the plug from the power source and/or the battery pack, if detachable, from the power tool before making any adjustments, changing accessories, or storing power tools.** Such preventive safety measures reduce the risk of starting the power tool accidentally.
- d) **Store idle power tools out of the reach of children and do not allow persons unfamiliar with the power tool or these instructions to operate the power tool.** Power tools are dangerous in the hands of untrained users.
- e) **Maintain power tools and accessories. Check for misalignment or binding of moving parts, breakage of parts and any other condition that may affect the power tool's operation. If damaged, have the power tool repaired before use.** Many accidents are caused by poorly maintained power tools.
- f) **Keep cutting tools sharp and clean.** Properly maintained cutting tools with sharp cutting edges are less likely to bind and are easier to control.
- g) **Use the power tool, accessories and tool bits, etc. in accordance with these instructions, taking into account the working conditions and the work to be performed.** Use of the power tool for operations different from those intended could result in a hazardous situation.
- h) **Keep handles and grasping surfaces dry, clean and free from oil and grease.** Slippery handles and grasping surfaces do not allow for safe handling and control of the tool in unexpected situations.

#### 5) Battery Tool Use and Care

- a) **Recharge only with the charger specified by the manufacturer.** A charger that is suitable for one type of battery pack may create a risk of fire when used with another battery pack.
- b) **Use power tools only with specifically designated battery packs.** Use of any other battery packs may create a risk of injury and fire.
- c) **When battery pack is not in use, keep it away from other metal objects, like paper clips, coins, keys, nails, screws or other small metal objects, that can make a connection from one terminal to another.** Shorting the battery terminals together may cause burns or a fire.
- d) **Under abusive conditions, liquid may be ejected from the battery; avoid contact. If contact accidentally occurs, flush with water. If liquid**

**contacts eyes, additionally seek medical help.** Liquid ejected from the battery may cause irritation or burns.

- e) **Do not use a battery pack or tool that is damaged or modified.** Damaged or modified batteries may exhibit unpredictable behaviour resulting in fire, explosion or risk of injury.
- f) **Do not expose a battery pack or tool to fire or excessive temperature.** Exposure to fire or temperature above 130 °C may cause explosion.
- g) **Follow all charging instructions and do not charge the battery pack or tool outside the temperature range specified in the instructions.** Charging improperly or at temperatures outside the specified range may damage the battery and increase the risk of fire.

#### 6) Service

- a) **Have your power tool serviced by a qualified repair person using only identical replacement parts.** This will ensure that the safety of the power tool is maintained.
- b) **Never service damaged battery packs.** Service of battery packs should only be performed by the manufacturer or authorized service providers.

### Additional Specific Safety Rules for Grease Guns

- **Parts of the tool or the hose assembly can break or rupture due to high pressure. Risk of serious injury may occur.** Before using, always inspect the tool and hose assembly for damage or wear. Never use if any part of the tool is damaged or worn.
- **Use only DEWALT-approved flexible hoses.** Hold the hose only by the flexible hose safety spring guard to avoid personal serious injury.
- **If the hose kinks or is damaged, a rupture may occur which could cause serious injury.** Replace the hose at the first sign of wear, kink or damage.
- **Only use the grease recommended in this manual (refer to Technical Data).**
- **To reduce the risk of serious personal injury, do not use the grease gun around or on moving parts, mechanisms or running equipment.**
- **Air vents often cover moving parts and should be avoided.** Loose clothes, jewelry or long hair can be caught in moving parts.



**WARNING: Risk of injection or severe injury.** Rupture of components can inject grease into skin or eyes, causing serious injury or infection. **Do not treat as a simple cut. Seek immediate medical attention.**



**WARNING: Output can be at high pressure.** Do not direct discharge at yourself or others.



**WARNING: The grease gun may generate high pressure—up to 69 MPa (690 bar).** Always wear gloves during operation. Keep hands clear of the exposed rubber portion of the hose.



 **WARNING: Grease and lubricants may be flammable.**  
Do not expose to flame or heat source. Follow all warnings and instructions from grease and lubricant manufacturer.

## Residual Risks

In spite of the application of the relevant safety regulations and the implementation of safety devices, certain residual risks cannot be avoided. These are:

- Risk of personal injury due to flying particles.
- Risk of burns due to accessories becoming hot during operation.
- Risk of personal injury due to prolonged use.

### SAVE THESE INSTRUCTIONS

## Chargers

DEWALT chargers require no adjustment and are designed to be as easy as possible to operate.

### Electrical Safety

The electric motor has been designed for one voltage only. Always check that the battery pack voltage corresponds to the voltage on the rating plate. Also make sure that the voltage of your charger corresponds to that of your mains.



Your DEWALT charger is double insulated in accordance with EN60335; therefore no earth wire is required.

If the supply cord is damaged, it must be replaced by a specially prepared cord available through the DEWALT service organisation.

### Mains Plug Replacement (U.K. & Ireland Only)

If a new mains plug needs to be fitted:

- Safely dispose of the old plug.
- Connect the brown lead to the live terminal in the plug.
- Connect the blue lead to the neutral terminal.



**WARNING:** No connection is to be made to the earth terminal.

Follow the fitting instructions supplied with good quality plugs. Recommended fuse: 3 A.

### Using an Extension Cable

An extension cord should not be used unless absolutely necessary. Use an approved extension cable suitable for the power input of your charger (see **Technical Data**). The minimum conductor size is 1 mm<sup>2</sup>; the maximum length is 30 m.

When using a cable reel, always unwind the cable completely.

### Important Safety Instructions for All Battery Chargers

**SAVE THESE INSTRUCTIONS:** This manual contains important safety and operating instructions for compatible battery chargers (refer to **Technical Data**).

- Before using charger, read all instructions and cautionary markings on charger, battery pack, and product using battery pack.



**WARNING:** Shock hazard. Do not allow any liquid to get inside charger. Electric shock may result.



**WARNING:** We recommend the use of a residual current device with a residual current rating of 30mA or less.



**CAUTION:** Burn hazard. To reduce the risk of injury, charge only DEWALT rechargeable batteries. Other types of batteries may burst causing personal injury and damage.



**CAUTION:** Children should be supervised to ensure that they do not play with the appliance.

**NOTICE:** Under certain conditions, with the charger plugged into the power supply, the exposed charging contacts inside the charger can be shorted by foreign material. Foreign materials of a conductive nature such as, but not limited to, steel wool, aluminum foil or any buildup of metallic particles should be kept away from charger cavities. Always unplug the charger from the power supply when there is no battery pack in the cavity. Unplug charger before attempting to clean

- **DO NOT attempt to charge the battery pack with any chargers other than the ones in this manual.** The charger and battery pack are specifically designed to work together.
- **These chargers are not intended for any uses other than charging DEWALT rechargeable batteries.** Any other uses may result in risk of fire, electric shock or electrocution.
- **Do not expose charger to rain or snow.**
- **Pull by plug rather than cord when disconnecting charger.** This will reduce risk of damage to electric plug and cord.
- **Make sure that cord is located so that it will not be stepped on, tripped over, or otherwise subjected to damage or stress.**
- **Do not use an extension cord unless it is absolutely necessary.** Use of improper extension cord could result in risk of fire, electric shock, or electrocution.
- **Do not place any object on top of charger or place the charger on a soft surface that might block the ventilation slots and result in excessive internal heat.** Place the charger in a position away from any heat source. The charger is ventilated through slots in the top and the bottom of the housing.
- **Do not operate charger with damaged cord or plug—** have them replaced immediately.
- **Do not operate charger if it has received a sharp blow, been dropped, or otherwise damaged in any way.** Take it to an authorised service centre.
- **Do not disassemble charger; take it to an authorised service centre when service or repair is required.** Incorrect reassembly may result in a risk of electric shock, electrocution or fire.
- In case of damaged power supply cord the supply cord must be replaced immediately by the manufacturer, its service agent or similar qualified person to prevent any hazard.
- **Disconnect the charger from the outlet before attempting any cleaning. This will reduce the risk of**

**electric shock.** Removing the battery pack will not reduce this risk.

- **NEVER** attempt to connect two chargers together.
- **The charger is designed to operate on standard 230V household electrical power. Do not attempt to use it on any other voltage.** This does not apply to the vehicular charger.

## Chargers

DeWALT chargers require no adjustment and are designed to be as easy as possible to operate.







### Charging a Battery (Fig. B)

1. Plug the charger into an appropriate outlet before inserting battery pack.
2. Insert the battery pack **16** into the charger, making sure the battery pack is fully seated in the charger. The red (charging) light will blink repeatedly indicating that the charging process has started.
3. The completion of charge will be indicated by the red light remaining ON continuously. The battery pack is fully charged and may be used at this time or left in the charger. To remove the battery pack from the charger, push the battery release button **17** on the battery pack.

**NOTE:** To ensure maximum performance and life of lithium-ion battery packs, charge the battery pack fully before first use.

### Charger Operation

Refer to the indicators below for the charge status of the battery pack.

Charge Indicators		
	Charging	
	Fully Charged	
	Hot/Cold Pack Delay*	

\*The red light will continue to blink, but a yellow indicator light will be illuminated during this operation. Once the battery pack has reached an appropriate temperature, the yellow light will turn off and the charger will resume the charging procedure.

The compatible charger(s) will not charge a faulty battery pack. The charger will indicate faulty battery by refusing to light.

**NOTE:** This could also mean a problem with a charger.

If the charger indicates a problem, take the charger and battery pack to be tested at an authorised service centre.

### Hot/Cold Pack Delay

When the charger detects a battery pack that is too hot or too cold, it automatically starts a Hot/Cold Pack Delay, suspending charging until the battery pack has reached an appropriate temperature. The charger then automatically switches to the pack charging mode. This feature ensures maximum battery pack life.

A cold battery pack will charge at a slower rate than a warm battery pack. The battery pack will charge at that slower rate

throughout the entire charging cycle and will not return to maximum charge rate even if the battery pack warms.

The DCB118 charger is equipped with an internal fan designed to cool the battery pack. The fan will turn on automatically when the battery pack needs to be cooled. Never operate the charger if the fan does not operate properly or if ventilation slots are blocked. Do not permit foreign objects to enter the interior of the charger.

### Electronic Protection System

XR Li-Ion tools are designed with an Electronic Protection System that will protect the battery pack against overloading, overheating or deep discharge.

The tool will automatically turn off if the Electronic Protection System engages. If this occurs, place the lithium-ion battery pack on the charger until it is fully charged.

### Wall Mounting

These chargers are designed to be wall mountable or to sit upright on a table or work surface. If wall mounting, locate the charger within reach of an electrical outlet, and away from a corner or other obstructions which may impede air flow. Use the back of the charger as a template for the location of the mounting screws on the wall. Mount the charger securely using drywall screws (purchased separately) at least 25.4 mm long with a screw head diameter of 7–9 mm, screwed into wood to an optimal depth leaving approximately 5.5 mm of the screw exposed. Align the slots on the back of the charger with the exposed screws and fully engage them in the slots.

### Charger Cleaning Instructions



**WARNING: Shock hazard. Disconnect the charger from the AC outlet before cleaning.** Dirt and grease may be removed from the exterior of the charger using a cloth or soft non-metallic brush. Do not use water or any cleaning solutions. Never let any liquid get inside the tool; never immerse any part of the tool into a liquid.

## Battery Packs

### Important Safety Instructions for All Battery Packs

When ordering replacement battery packs, be sure to include catalogue number and voltage.

The battery pack is not fully charged out of the carton. Before using the battery pack and charger, read the safety instructions below. Then follow charging procedures outlined.

#### READ ALL INSTRUCTIONS

- **Do not charge or use battery in explosive atmospheres, such as in the presence of flammable liquids, gases or dust.** Inserting or removing the battery from the charger may ignite the dust or fumes.
- **Never force battery pack into charger. Do not modify battery pack in any way to fit into a non-compatible charger as battery pack may rupture causing serious personal injury.**
- Charge the battery packs only in DeWALT chargers.
- **DO NOT** splash or immerse in water or other liquids.

- **Do not store or use the tool and battery pack in locations where the temperature may reach or exceed 40 °C (104 °F) (such as outside sheds or metal buildings in summer).**
- **Do not incinerate the battery pack even if it is severely damaged or is completely worn out.** The battery pack can explode in a fire. Toxic fumes and materials are created when lithium-ion battery packs are burned.
- **If battery contents come into contact with the skin, immediately wash area with mild soap and water.** If battery liquid gets into the eye, rinse water over the open eye for 15 minutes or until irritation ceases. If medical attention is needed, the battery electrolyte is composed of a mixture of liquid organic carbonates and lithium salts.
- **Contents of opened battery cells may cause respiratory irritation.** Provide fresh air. If symptoms persists, seek medical attention.



**WARNING:** Burn hazard. Battery liquid may be flammable if exposed to spark or flame.



**WARNING:** Never attempt to open the battery pack for any reason. If battery pack case is cracked or damaged, do not insert into charger. Do not crush, drop or damage battery pack. Do not use a battery pack or charger that has received a sharp blow, been dropped, run over or damaged in any way (i.e., pierced with a nail, hit with a hammer, stepped on). Electric shock or electrocution may result. Damaged battery packs should be returned to service centre for recycling.



**WARNING:** Fire hazard. Do not store or carry the battery pack so that metal objects can contact exposed battery terminals. For example, do not place the battery pack in aprons, pockets, tool boxes, product kit boxes, drawers, etc., with loose nails, screws, keys, etc.



**CAUTION:** When not in use, place tool on its side on a stable surface where it will not cause a tripping or falling hazard. Some tools with large battery packs will stand upright on the battery pack but may be easily knocked over.

## Transportation



**WARNING:** Fire hazard. Transporting batteries can possibly cause fire if the battery terminals inadvertently come in contact with conductive materials. When transporting batteries, make sure that the battery terminals are protected and well insulated from materials that could contact them and cause a short circuit.

**NOTE:** Lithium-ion batteries should not be put in checked baggage.

DeWALT batteries comply with all applicable shipping regulations as prescribed by industry and legal standards which include UN Recommendations on the Transport of Dangerous Goods; International Air Transport Association (IATA) Dangerous Goods Regulations, International Maritime Dangerous Goods (IMDG) Regulations, and the European Agreement Concerning The International Carriage of Dangerous Goods by Road (ADR). Lithium-ion cells and batteries have been tested to section 38.3

of the UN Recommendations on the Transport of Dangerous Goods Manual of Tests and Criteria.

In most instances, shipping a DeWALT battery pack will be excepted from being classified as a fully regulated Class 9 Hazardous Material. In general, only shipments containing a lithium-ion battery with an energy rating greater than 100 Watt Hours (Wh) will require being shipped as fully regulated Class 9. All lithium-ion batteries have the Watt Hour rating marked on the pack. Furthermore, due to regulation complexities, DeWALT does not recommend air shipping lithium-ion battery packs alone regardless of Watt Hour rating. Shipments of tools with batteries (combo kits) can be air shipped as excepted if the Watt Hour rating of the battery pack is no greater than 100 Whr. Regardless of whether a shipment is considered excepted or fully regulated, it is the shipper's responsibility to consult the latest regulations for packaging, labeling/marketing and documentation requirements.

The information provided in this section of the manual is provided in good faith and believed to be accurate at the time the document was created. However, no warranty, expressed or implied, is given. It is the buyer's responsibility to ensure that its activities comply with the applicable regulations.

## Transporting the FLEXVOLT™ Battery

The DeWALT FLEXVOLT™ battery has two modes: **Use** and **Transport**.

**Use Mode:** When the FLEXVOLT™ battery stands alone or is in a DeWALT 18V product, it will operate as an 18V battery. When the FLEXVOLT™ battery is in a 54V or a 108V (two 54V batteries) product, it will operate as a 54V battery.

**Transport Mode:** When the cap is attached to the FLEXVOLT™ battery, the battery is in Transport mode. Keep the cap for shipping.

When in Transport mode, strings of cells are electrically disconnected within the pack resulting in 3 batteries with a lower Watt hour (Wh) rating as compared to 1 battery with a higher Watt hour rating. This increased quantity of 3 batteries with the lower Watt hour rating can exempt the pack from certain shipping regulations that are imposed upon the higher Watt hour batteries.

For example, the Transport Wh rating might indicate 3 x 36 Wh, meaning 3 batteries of 36 Wh each.

The Use Wh rating might indicate 108 Wh (1 battery implied).

Example of Use and Transport Label Marking



## Storage Recommendations

1. The best storage place is one that is cool and dry away from direct sunlight and excess heat or cold. For optimum battery performance and life, store battery packs at room temperature when not in use.
2. For long storage, it is recommended to store a fully charged battery pack in a cool, dry place out of the charger for optimal results.

**NOTE:** Battery packs should not be stored completely depleted of charge. The battery pack will need to be recharged before use.

### Labels on Charger and Battery Pack

In addition to the pictographs used in this manual, the labels on the charger and the battery pack may show the following pictographs:



Read instruction manual before use.



See **Technical Data** for charging time.



Do not probe with conductive objects.



Do not charge damaged battery packs.



Do not expose to water.



Have defective cords replaced immediately.



Charge only between 4 °C and 40 °C.



Only for indoor use.



Discard the battery pack with due care for the environment.

LI-ION



Charge DEWALT battery packs only with designated DEWALT chargers. Charging battery packs other than the designated DEWALT batteries with a DEWALT charger may make them burst or lead to other dangerous situations.



Do not incinerate the battery pack.



USE (without transport cap). Example: Wh rating indicates 108 Wh (1 battery with 108 Wh).



TRANSPORT (with built-in transport cap). Example: Wh rating indicates 3 x 36 Wh (3 batteries of 36 Wh).

### Battery Type

The DCGG571 operates on an 18 volt battery pack. These battery packs may be used: DCB181, DCB182, DCB183, DCB183B, DCB184, DCB184B, DCB185, DCB187, DCB189, DCB546, DCB547, DCB548. Refer to **Technical Data** for more information.

### Package Contents

The package contains:

- 1 Grease gun
- 1 Charger
- 1 Li-Ion battery pack (C1, D1, L1, M1, P1, S1, T1, X1, Y1 models)
- 2 Li-Ion battery packs (C2, D2, L2, M2, P2, S2, T2, X2, Y2 models)
- 3 Li-Ion battery packs (C3, D3, L3, M3, P3, S3, T3, X3, Y3 models)
- 1 Instruction manual

**NOTE:** Battery packs, chargers and kitboxes are not included with N models. Battery packs and chargers are not included with NT models. B models include Bluetooth® battery packs.

**NOTE:** The Bluetooth® word mark and logos are registered trademarks owned by the Bluetooth®, SIG, Inc. and any use of such marks by DEWALT is under license. Other trademarks and trade names are those of their respective owners.

- Check for damage to the tool, parts or accessories which may have occurred during transport.
- Take the time to thoroughly read and understand this manual prior to operation.

### Markings on Tool

The following pictographs are shown on the tool:



Read instruction manual before use.

### Date Code Position (Fig. A)

The date code **34**, which also includes the year of manufacture, is printed into the housing.

Example:

2019 XX XX  
Year of Manufacture

### Description (Fig. A, E)



**WARNING:** Never modify the power tool or any part of it. Damage or personal injury could result.

#### Fig. A

- |                                     |                              |
|-------------------------------------|------------------------------|
| 1 Variable speed trigger switch     | 15 Retaining slot            |
| 2 Lock-off button                   | 16 Battery                   |
| 3 Handle                            | 17 Battery release button    |
| 4 LED worklight                     | 18 Rubber feet               |
| 5 LED worklight button              | 19 Hose clip                 |
| 6 Top cap                           | 20 Shoulder strap mount      |
| 7 Flexible hose                     | 21 Shoulder strap clip holes |
| 8 Flexible hose safety spring guard | 22 Filter                    |
| 9 Flexible hose coupler             | <b>Fig. E</b>                |
| 10 Grease tube                      | 23 Pressure relief valve     |
| 11 Grease tube cap                  | 24 Purge valve               |
| 12 Grease tube handle               | 25 Check valve               |
| 13 Grease tube rod                  | 26 1/8" NPT fill port        |
| 14 Grease tube assembly             | 27 1/8" NPT fill port plug   |

## Intended Use

This grease gun is designed for professionally dispensing lubricant.

**DO NOT** use under wet conditions or in the presence of flammable liquids or gases.

This grease gun is a professional power tool.

**DO NOT** let children come into contact with the tool. Supervision is required when inexperienced operators use this tool.

- **Young children and the infirm.** This appliance is not intended for use by young children or infirm persons without supervision.
- This product is not intended for use by persons (including children) suffering from diminished physical, sensory or mental abilities; lack of experience, knowledge or skills unless they are supervised by a person responsible for their safety. Children should never be left alone with this product.

## LED Worklight (Fig. A, C)

There is an LED worklight **4** located on the top cap **6**. The worklight is activated when the trigger switch is depressed and when the LED worklight button **5** is in the ON position. When the LED worklight button is in the OFF position, the LED worklight will not turn on when the trigger is depressed. The worklight will automatically turn off 20 seconds after the trigger switch is released. If the trigger switch remains depressed, the worklight will remain on.

**NOTE:** The worklight is for lighting the immediate work surface and is not intended to be used as a flashlight.

## Variable Speed Trigger Switch (Fig. A, D)

### Lock-Off Button and Trigger Switch

Your grease gun is equipped with a lock-off button **2**.

To lock the trigger switch, press the lock-off button as shown in Figure D. Always lock the trigger switch **1** when carrying or storing the tool to eliminate unintentional starting. The lock-off button is coloured red to indicate when the switch is in its unlocked position.

To unlock the trigger switch, press the lock-off button as shown in Figure D. Squeeze the trigger switch to turn the motor ON. Releasing the trigger switch turns the motor OFF.

**NOTE:** The variable speed trigger switch will give you added versatility. The further the trigger is depressed the higher the output of grease.



**WARNING:** This tool has no provision to lock the switch in the ON position, and should never be locked ON by any other means.

## Pressure Relief Valve (Fig. E)

The pressure relief valve **23** is set at the factory to relieve pressure above 69 MPa (690 bar). Grease coming out of the pressure relief valve indicates a clog in the fitting, line or bearing. Any of these conditions must be corrected before proceeding.



**WARNING:** The grease gun may generate high pressure. Do not remove or tamper with the pressure relief valve. Serious injury may occur.

## Shoulder Strap (Fig. A)

Your grease gun comes with a shoulder strap. Hook the shoulder strap clips into the shoulder strap clip holes **21** found on the shoulder strap mount **20**.

## ASSEMBLY AND ADJUSTMENTS



**WARNING:** To reduce the risk of serious personal injury, turn tool off and disconnect battery pack before making any adjustments or removing/installing attachments or accessories. An accidental start-up can cause injury.



**WARNING:** Use only DEWALT battery packs and chargers.

## Inserting and Removing the Battery Pack from the Tool (Fig. F)

**NOTE:** Make sure your battery pack **16** is fully charged.

### To Install the Battery Pack into the Tool Handle

1. Align the battery pack **16** with the rails inside the tool's handle (Fig. F).
2. Slide it into the handle until the battery pack is firmly seated in the tool and ensure that you hear the lock snap into place.

### To Remove the Battery Pack from the Tool

1. Press the battery release button **17** and firmly pull the battery pack out of the tool handle.
2. Insert battery pack into the charger as described in the charger section of this manual.

## Fuel Gauge Battery Packs (Fig. F)

Some DEWALT battery packs include a fuel gauge which consists of three green LED lights that indicate the level of charge remaining in the battery pack.

To actuate the fuel gauge, press and hold the fuel gauge button **32**. A combination of the three green LED lights will illuminate designating the level of charge left. When the level of charge in the battery is below the usable limit, the fuel gauge will not illuminate and the battery will need to be recharged.

**NOTE:** The fuel gauge is only an indication of the charge left on the battery pack. It does not indicate tool functionality and is subject to variation based on product components, temperature and end-user application.

## Installing a Grease Cartridge (Fig. A, E, G)

1. Pull the grease tube handle **12** out as far as it will go, then secure the grease tube rod **13** into the retaining slot **15** by moving the rod to the side. Ensure the rod is placed securely in the slot to prevent it from disengaging.
2. Unscrew the grease tube assembly **14** from the grease gun.
3. Remove the plastic cap from the grease cartridge, then insert the cartridge, open end first, into the grease tube **10**.
4. Remove the seal from the other end of the grease cartridge.

5. Thread the grease tube assembly **14** back into the grease gun and screw it in securely.
6. Release the grease tube rod **13** from the retaining slot **15** and slowly press it back into the tube.
7. Use the purge valve (**24**, Fig. E) to bleed off any air that may be trapped in the cartridge. Refer to **Purging Air Pockets**.

**IMPORTANT:** The grease gun will lose its prime if there are air pockets in the lubricant.

### Removing Empty Grease Cartridge (Fig. A)

1. Pull the grease tube handle **12** out as far as it will go, then secure the grease tube rod **13** into the retaining slot **15** by moving the rod to the side. Ensure the rod is placed securely in the slot to prevent it from disengaging.
2. Unscrew the grease tube assembly **14** from the grease gun and remove.
3. Gently release the grease tube handle **12** to expel the empty cartridge from the grease tube.

### Filling the Grease Gun from a Bulk Container (Fig. A, G–J)

#### Preparing the Grease Gun for Suction and Filler Pump Filling (Fig. A, H)

**NOTE:** Be sure the grease gun is empty of grease before beginning this process.

1. Unscrew the grease tube **10** from the grease gun assembly **14**.
2. Unscrew the grease tube cap **11** from the grease tube **10** and pull out the grease rod **13**.
3. Using your thumb and forefinger, flip the rubber seal **33** from the rear to the front. Refer to Figure H.

**NOTE:** The seal resembles a cup, which should open toward the top cap (**6**, Fig. A) when prepared for suction and filler pump filling.

4. Reinsert the grease tube rod **13** back into the grease tube **10**.

#### Suction Filling from a Bulk Container (Fig. A, E, G, I)

1. Put the open end of the grease tube assembly into the bulk lubricant.
2. Slowly pull back the grease tube handle **12** to suction the lubricant into the grease gun.

**NOTE:** Be sure to keep the open end of the grease tube assembly far enough into the lubricant to prevent air pockets in the grease tube.

3. When the grease tube rod **13** is fully extended, secure it into the retaining slot **15**.
4. Remove the grease gun tube assembly from the bulk lubricant and wipe off excess grease.
5. Screw the grease gun tube assembly **14** back into the grease gun.
6. Release the grease tube rod **13** from the retaining slot **15** and slowly press it back into the tube.

7. Use the purge valve (**24**, Fig. E) to bleed off any air that may be trapped in the cartridge. Refer to **Purging Air Pockets**.

### Filler Pump Filling From a Bulk Container (Fig. A, E, G, I)

This tool comes with a 1/8" NPT fill port (**26**, Fig. E) for attaching a low pressure fill coupler onto the unit.

 **WARNING:** Never thread a high-pressure coupler onto the grease gun's 1/8" NPT fill port. Serious injury may occur due to excessive pressure. Use low-pressure couplers only.

 **CAUTION:** The fill pump loader must connect correctly with the grease gun's 1/8" NPT port. The filler pump may not operate if the components are not compatible.

#### Installing The Low Pressure Coupler (Not Supplied With The Tool)

1. Thread the grease tube assembly **14** back into the grease gun and screw it in securely.
2. Pull the grease tube handle **12** out as far as it will go, then secure the grease tube rod **13** into the retaining slot **15** by moving the rod to the side. Ensure the rod is placed securely in the slot to prevent it from disengaging.
3. Remove the 1/8" NPT fill port plug **27** from the fill port.
4. Thread the appropriate low pressure coupler onto the 1/8" NPT fill port **26**.
5. Release the grease tube rod **13** from the retaining slot **15** and slowly press it back into the tube.
6. Use the purge valve **24** to bleed off any air that may be trapped in the cartridge. Refer to **Purging Air Pockets**.

#### Filling The Tool From The Low Pressure Filler Pump (Fig. A, J)

1. Pull back on the grease tube handle slowly and rotate the rod until it is secure in place.  
**NOTE:** Do not lock the rod into the retaining slot **15**.
2. Connect the low pressure fitting on the grease gun to the appropriate low pressure fitting on the filler pump. These fittings DO NOT lock together. This prevents the grease gun cartridge from being over filled.
3. Fill until the rod is pushed out of the grease tube approximately 20 cm. Do not overfill. If the rod fails to move during the filling process, stop. This indicates that the rod is not connected to the plunger and step one must be repeated before proceeding.
4. Rotate rod to release and carefully push rod back into the grease tube.
5. Use the purge valve **24** to bleed off any air that may be trapped in the cartridge. Refer to **Purging Air Pockets**.

### Purging Air Pockets (Fig. A, E)

**IMPORTANT:** Air pockets in the grease can cause the grease gun to lose prime. Eliminate air pockets after each refill or if the grease gun fails to pump grease:



1. Unscrew the purge valve **24** without removing it, until all air has escaped.
2. Tighten the purge valve **24**.

- Uncap the flexible hose **7** then depress the variable speed trigger switch **1** for 10–20 seconds.
- If grease fails to flow through the hose, repeat from step 1.



**NOTE:** This tool has been tested at the factory, which may result in a small amount of grease left in the grease tube and hose assembly. It is recommended to purge the tool with the brand of grease to be used before first use.

## OPERATION

### Instructions for Use

-  **WARNING:** Always observe the safety instructions and applicable regulations.
-  **WARNING:** To reduce the risk of serious personal injury, turn tool off and disconnect battery pack before making any adjustments or removing/installing attachments or accessories. An accidental start-up can cause injury.

### Proper Hand Position (Fig. A, K)

-  **WARNING:** To reduce the risk of serious personal injury, ALWAYS use proper hand position as shown.
-  **WARNING:** To reduce the risk of serious personal injury, ALWAYS hold securely in anticipation of a sudden reaction.

Proper hand position requires one hand on the flexible hose safety spring guard **8** with the other hand on the handle **3** as shown.

### Using the Grease Gun (Fig. A)

-  **WARNING:** To reduce the risk of serious personal injury, always maintain a grip on the handle when operating the grease gun or positioning the hose onto fittings.

To operate the grease gun, hold the grease gun by the handle **3**, or place it on a stable surface upright on its rubber feet **18** maintaining a grip on the handle. Holding the hose by the flexible hose safety spring guard **8**, connect the flexible hose grease coupler **9** or other appropriate grease coupler, onto the grease fitting to be filled. Carefully depress the variable speed trigger switch to begin the filling process. Once the correct amount of grease has been dispensed, release the trigger and remove the coupler from the grease fitting. If the coupler does not release, there may still be residual pressure in the line. Moving the coupler from side to side can relieve the residual pressure so it can be removed from the coupling. If the coupler leaks excessively or does not hold on to the grease fitting, it should be replaced.

## MAINTENANCE

Your DEWALT power tool has been designed to operate over a long period of time with a minimum of maintenance. Continuous satisfactory operation depends upon proper tool care and regular cleaning.

-  **WARNING:** To reduce the risk of serious personal injury, turn tool off and disconnect battery pack before making any adjustments or removing/

*installing attachments or accessories. An accidental start-up can cause injury.*

The charger and battery pack are not serviceable.





### Lubrication

Your power tool requires no additional lubrication.



### Cleaning

-  **WARNING:** Blow dirt and dust out of the main housing with dry air as often as dirt is seen collecting in and around the air vents. Wear approved eye protection and approved dust mask when performing this procedure.
-  **WARNING:** Never use solvents or other harsh chemicals for cleaning the non-metallic parts of the tool. These chemicals may weaken the materials used in these parts. Use a cloth dampened only with water and mild soap. Never let any liquid get inside the tool; never immerse any part of the tool into a liquid.

### Cleaning Contaminants from the Grease Gun

#### Cleaning Contamination from the Check Valve (Fig. L)

Should the grease gun fail to dispense grease, the check valve **25** should be cleaned.

- Remove the check valve plug **28**, then the disc **31**, spring **30** and check valve ball **29**.
- Clean the ball **29** and the check valve area in the main casting.
- Reinstall the ball **29**, the spring **30**, and then the disc **31**.
- After all grease is cleaned from the area, reinstall the check valve plug **28**.

#### Cleaning Contamination from the Filter (Fig. A, G, M)

Should the grease gun fail to dispense grease, clean the filter **22**.

**NOTE:** If there is still grease in the tube, open the purge valve prior to pulling the tube handle.

- Pull the grease tube handle **12** out as far as it will go, then secure the grease tube rod **13** into the retaining slot **15** by moving the rod to the side. Ensure the rod is placed securely in the slot to prevent it from disengaging.
- Unscrew the grease tube assembly **14** from the grease gun and remove.
- Using a small flat-blade screwdriver or pick, carefully pop out the filter.
- Wipe off the filter using a soft cloth. If the filter still has debris in it after wiping, a soft brush or swab may be used.

- Once clean, reinsert the filter into the round groove, ensuring it is fully seated, and reattach the grease tube assembly to the grease gun.

### Optional Accessories

**⚠ WARNING:** *Since accessories, other than those offered by DeWALT, have not been tested with this product, use of such accessories with this tool could be hazardous. To reduce the risk of injury, only DeWALT recommended accessories should be used with this product.*

Consult your dealer for further information on the appropriate accessories.

### Protecting the Environment



Separate collection. Products and batteries marked with this symbol must not be disposed of with normal household waste.

■ Products and batteries contain materials that can be recovered or recycled reducing the demand for raw materials.

Please recycle electrical products and batteries according to local provisions. Further information is available at [www.2helpU.com](http://www.2helpU.com).

### Rechargeable Battery Pack

This long life battery pack must be recharged when it fails to produce sufficient power on jobs which were easily done before. At the end of its technical life, discard it with due care for our environment:

- Run the battery pack down completely, then remove it from the tool.
- Li-Ion cells are recyclable. Take them to your dealer or a local recycling station. The collected battery packs will be recycled or disposed of properly

## Troubleshooting

Problem	Possible Cause	Possible Solution
Unable to pull back rod	Vacuum build up	Unscrew the purge valve to release vacuum.
Unable to push rod forward	Pressure build up	Unscrew the purge valve to release pressure.
	Rod is still connected to plunger	Rotate grease tube handle 90 degrees to disengage it.
No grease when trigger is pulled	Grease tube is empty	Add grease.
	Air pockets in the grease tube	Refer to <b>Purging Air Pockets.</b>
	Check valve is clogged	Refer to <b>Cleaning Contamination from the Check Valve.</b>
Grease appears in relief valve	Filter is clogged	Refer to <b>Cleaning Contamination from the Filter.</b>
	Zerk fitting is blocked	Disconnect coupler from fitting, clean zerk fitting and grease path.
Motor does not run when trigger is pulled	Battery	Make sure the battery is fully charged.
Grease leaks out of the back of the grease tube	Rubber seal is flipped the wrong direction	Refer to <b>Preparing the Grease Gun for Suction and Filler Pump Filling.</b>









<b>Belgique et Luxembourg België en Luxemburg</b>	DeWALT – Belgium BVBA Egide Walschaertsstraat 16 2800 Mechelen	Tel: NL 32 15 47 37 63 Tel: FR 32 15 47 37 64 Fax: 32 15 47 37 99	www.dewalt.be enduser.BE@SBDInc.com
<b>Danmark</b>	DeWALT (Stanley Black&Decker AS) Roskildevej 22 2620 Albertslund	Tel: 70 20 15 10 Fax: 70 22 49 10	www.dewalt.dk kundeservice.dk@sbdinc.com
<b>Deutschland</b>	DeWALT Richard Klingner Str. 11 65510 Idstein	Tel: 06126-21-0 Fax: 06126-21-2770	www.dewalt.de infodwge@sbdinc.com
<b>Ελλάδα</b>	DeWALT (Ελλάδα) A.E. ΕΔΠΑ-ΓΡΑΦΕΙΑ : Στραβανός 7 & Λ. Βουλιαγμένης, Γλυφάδα 166 74, Αθήνα SERVICE : Ημερος Τόπος 2 (Χάνι Αδών) – 193 00 Ασπρόπυργος	Τηλ: 00302108981616 Φαξ: 00302108983570	www.dewalt.gr Greece.Service@sbdinc.com
<b>España</b>	DeWALT Ibérica, S.C.A. Parc de Negocios "Mas Blau" Edificio Muntadas, c/Bergadà, 1, Of. A6 08820 El Prat de Llobregat (Barcelona)	Tel: 934 797 400 Fax: 934 797 419	www.dewalt.es respuesta.postventa@sbdinc.com
<b>France</b>	DeWALT (Stanley Black & Decker France SAS) 62 Chemin de la Bruyère CS 60105, 69574 DARDILLY Cedex	Tel: 04 72 20 39 20 Fax: 04 72 20 39 00	www.dewalt.fr scuf@sbdinc.com
<b>Schweiz Suisse Svizzera</b>	DeWALT In der Luberzen 42 8902 Urdorf	Tel: 044 - 755 60 70 Fax: 044 - 730 70 67	www.dewalt.ch service@rofaq.ch
<b>Ireland</b>	DeWALT Building 4500, Kinsale Road Cork Airport Business Park Cork, Ireland	Tel: 00353-2781800 Fax: 01278 1811	www.dewalt.ie Sales.ireland@sbdinc.com
<b>Italia</b>	DeWALT via Energypark 6 20871 Vimercate (MB), IT	Tel: 800-014353 39 039-9590200 Fax: 39 039-9590311	www.dewalt.it
<b>Nederlands</b>	DeWALT Netherlands BVPPostbus 83, 6120 AB BORN	Tel: 31 164 283 063 Fax: 31 164 283 200	www.dewalt.nl
<b>Norge</b>	DeWALT Postboks 4613 0405 Oslo, Norge	Tel: 45 25 13 00 Fax: 45 25 08 00	www.dewalt.no kundeservice.no@sbdinc.com
<b>Österreich</b>	DeWALT Werkzeug Vertriebsges m.b.H Oberlaaerstrasse 248, A-1230 Wien	Tel: 01 - 66116 - 0 Fax: 01 - 66116 - 614	www.dewalt.at service.austria@sbdinc.com
<b>Portugal</b>	DeWALT Ed. D Dirnis, Quina da Fonte Rua dos Malhoes 2 2A 2º Esq. Oeiras e S. Juliao da Barra, paço de Arcos e Caxias 2770 071 Paço de Arcos	Tel: +351 214667500 Fax: +351214667580	www.dewalt.pt resposta.posvenda@sbdinc.com
<b>Suomi</b>	DeWALT PL47 00521 Helsinki, Suomi	Puh: 010 400 4333 Faksi: 0800 411 340	www.dewalt.fi asiakaspalvelu.fi@sbdinc.com
<b>Sverige</b>	DeWALT BOX 94 43122 Mölndal Sverige	Tel: 031 68 61 60 Fax: 031 68 60 08	www.dewalt.se kundeservice.se@sbdinc.com
<b>Türkiye</b>	Sanayi ve Ticaret Bakanlıği tebliğince kullanım ömrü 7 yıldır. Stanley Black & Decker Turkey Alet Üretim San. Tic. Ltd.Şti. AND Kozyatağı – İçerenköy Mah. Umut Sok. AND Ofis Sit. No: 10-12 / 82-83-84 Ataşehir/İstanbul, Türkiye	Tel: +90 216 665 2900 Faks: +90 216 665 2901	www.dewalt.com.tr info-tr@sbdinc.com
<b>United Kingdom</b>	DeWALT, 210 Bath Road; Slough, Berks SL1 3YD	Tel: 01753-567055 Fax: 01753-572112	www.dewalt.co.uk emaservice@sbdinc.com
<b>Australia</b>	DeWALT 810 Whitehorse Road Box Hill VIC 3128 Australia	Tel: Aust 1800 338 002 Tel: NZ 0800 339 258	www.dewalt.com.au www.dewalt.co.nz
<b>Middle East Africa</b>	DeWALT P.O. Box - 17164, Jebel Ali Free Zone (South), Dubai, UAE	Tel: 971 4 812 7400 Fax: 971 4 2822765	www.dewalt.ae Service.MEA@sbdinc.com