

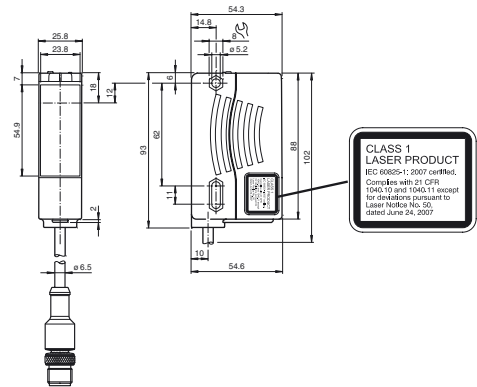

Dimensions



Model Number

VDM28-8-L1-IO/33/110/115b/122

Distance sensor
with 150 mm fixed cable and 4-pin, M12 x 1 connector

Features

- Distance measurement using object
- Measuring method PRT (Pulse Ranging Technology)
- Accurate, clear, and reproducible measuring results
- Red laser as the light emitter
- Version with IO-Link interface
- Version with analog output
- Laser class 1, eyesafe

Product information

The VDM28 distance measurement device employs Pulse Ranging Technology (PRT). It has a repeat accuracy of 5 mm with an operating range of 0.2 ... 8 m and an absolute accuracy of 25 mm. The compact housing of the Series 28 photoelectric sensors, with dimensions of 88 mm (height), 26 mm (width) and 54 mm (depth), make it the smallest device available in its class.

Electrical connection

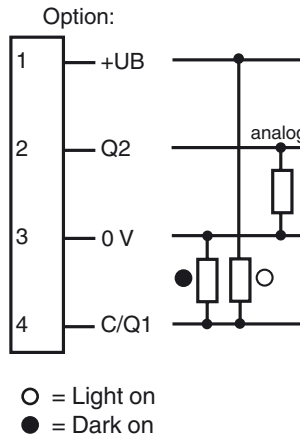

Pinout

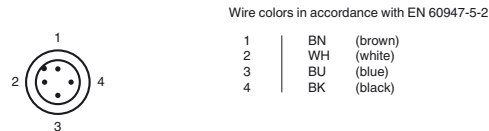

Indicators/operating means

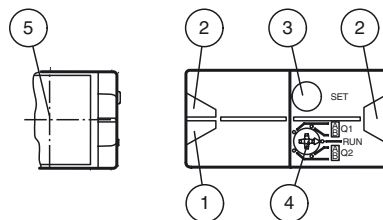

1	Operating display	green
2	Signal display	yellow
3	TEACH-IN button	
4	Mode rotary switch	
5	Laser output	

Release date: 2017-10-16 12:24 Date of issue: 2017-10-16 297904_eng.xml

Refer to "General Notes Relating to Pepperl+Fuchs Product Information".

Technical data**General specifications**

Measurement range	0.2 ... 8 m
Reference target	Kodak white (90%)
Light source	laser diode typ. service life 85,000 h at Ta = +25 °C
Light type	modulated visible red light
Laser nominal ratings	
Note	LASER LIGHT , DO NOT STARE INTO BEAM
Laser class	1
Wave length	660 nm
Beam divergence	< 1.5 mrad
Pulse length	approx. 4 ns
Repetition rate	250 kHz
max. pulse energy	< 1.5 nJ
Angle deviation	max. ± 2°
Measuring method	Pulse Ranging Technology (PRT)
Diameter of the light spot	< 10 mm at a distance of 8 m at 20 °C
Ambient light limit	50000 Lux
Temperature influence	typ. ≤ 0.25 mm/K

Functional safety related parameters

MTTF _d	200 a
Mission Time (T _M)	10 a
Diagnostic Coverage (DC)	0 %

Indicators/operating means

Operation indicator	LED green
Function indicator	2 LEDs yellow for switching state
Teach-In indicator	Teach-In: LED green/yellow equiphase flashing; 2.5 Hz Teach Error: LED green/yellow non equiphase flashing; 8.0 Hz
Control elements	5-step rotary switch for operating modes selection (threshold setting and operating modes)
Control elements	Switch for setting the threshold values

Electrical specifications

Operating voltage	U _B	10 ... 30 V DC / when operating in IO-Link mode: 18 ... 30 V
Ripple		10 % within the supply tolerance
No-load supply current	I ₀	≤ 70 mA / 24 V DC
Time delay before availability	t _v	1.5 s

Interface

Interface type	IO-Link
Protocol	IO-Link V1.0
Cycle time	min. 2.3 ms
Mode	COM 2 (38.4 kBaud)
Process data width	16 bit
SIO mode support	yes

Output

Signal output	Push-pull output, short-circuit protected, reverse polarity protected	
Switching voltage	max. 30 V DC	
Switching current	max. 100 mA	
Measurement output	1 analog output 4 ... 20 mA, short-circuit/overload protected	
Switching frequency	f	50 Hz
Response time	10 ms	

Measurement accuracy

Absolute accuracy	± 25 mm
Repeat accuracy	< 5 mm

Ambient conditions

Ambient temperature	-30 ... 55 °C (-22 ... 131 °F)
Storage temperature	-30 ... 70 °C (-22 ... 158 °F)

Mechanical specifications

Housing width	25.8 mm
Housing height	88 mm
Housing depth	54.6 mm
Degree of protection	IP67
Connection	fixed cable 150 mm with M12 x 1 male connector, 4 pin
Material	
Housing	Plastic ABS
Optical face	Plastic pane
Mass	90 g

Compliance with standards and directives

Standard conformity	
Product standard	EN 60947-5-2
Laser class	IEC 60825-1:2007 Complies with 21 CFR 1040.10 and 1040.11 except for deviations pursuant to Laser Notice No. 50, dated June 24, 2007

Laserlabel**CLASS 1
LASER PRODUCT**

IEC 60825-1: 2007 certified.

Complies with 21 CFR 1040.10 and 1040.11 except for deviations pursuant to Laser Notice No. 50, dated June 24, 2007

Accessories**PACTware 4.1**

FDT Framework

VDM28 IODD

IODD for communication with VDM28-IO-Link sensors

VDM28-IO-Link DTM

Device DTM for communication with VDM28-IO-Link sensors

IO-Link-Master02-USB

IO-Link master, supply via USB port or separate power supply, LED indicators, M12 plug for sensor connection

IO-Link-Master-USB DTM

Communication DTM for use of IO-Link-Master

IODD Interpreter DTM

Software for the integration of IODDs in a frame application (e. g. PACTware)

OMH-05

Mounting aid for round steel ø 12 mm or sheet 1.5 mm ... 3 mm

OMH-07-01

Mounting aid for round steel ø 12 mm or sheet 1.5 mm ... 3 mm

OMH-21

Mounting bracket

OMH-22

Mounting bracket

OMH-VDM28-01

Metal enclosure for inserting protective panes or apertures

OMH-VDM28-02

Mounting and fine adjustment device for sensors from the 28 series

OMH-RLK29-HW

Mounting bracket for rear wall mounting

OMH-K01

dove tail mounting clamp

OMH-K03

dove tail mounting clamp

OMH-MLV11-K

dove tail mounting clamp

Other suitable accessories can be found at www.pepperl-fuchs.com

Approvals and certificates

Protection class	II, rated voltage ≤ 250 V AC with pollution degree 1-2 according to IEC 60664-1
UL approval	cULus Listed, Class 2 Power Source, Type 1 enclosure
CCC approval	CCC approval / marking not required for products rated ≤36 V

Curves/Diagrams

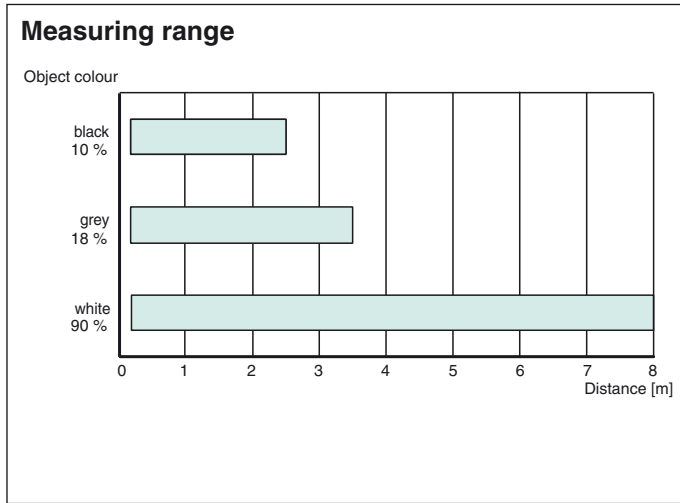

Preferences

Teach-In:

You can use the rotary switch to select the relevant switching threshold A and/or B for teaching in for switching output Q1. The yellow LEDs indicate the current state of the selected output.

To store a switching threshold (distance measured value), press and hold the "SET" button until the yellow and green LEDs flash in phase (approx. 2 s). Teach-In starts when the "SET" button is released.

Successful Teach-In is indicated by alternating flashing (2.5 Hz) of the yellow and green LEDs.

An unsuccessful Teach-In is indicated by rapidly alternating flashing (8 Hz) of the yellow and green LEDs.

After an unsuccessful Teach-In, the sensor continues to operate with the previous valid setting after the relevant visual fault signal is issued.

Different switching modes can be defined by teaching in the relevant distance measured values for the switching thresholds A and B:

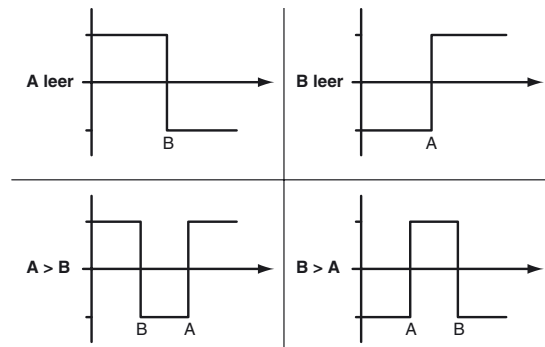

Every taught-in switching threshold can be retaught (overwritten) by pressing the SET button again.

Pressing and holding the "SET" button for > 5 s completely deletes the taught-in value. The yellow and green LEDs go out simultaneously to indicate that this procedure has been completed.

Minimum and maximum values for the analog output Q2 are taught in the same way as those for the switching output:

The following values apply: A = 4 mA
B = 20 mA

This provides three different options for operation:

A < B -> rising slope

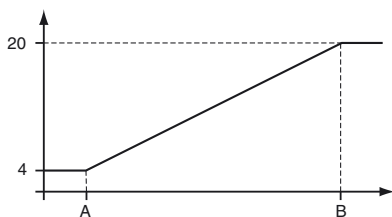

A > B -> falling slope

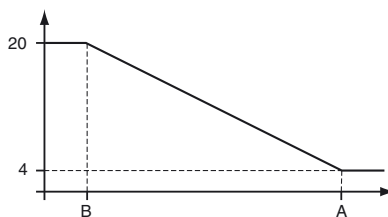

Release date: 2017-10-16 12:24 Date of issue: 2017-10-16 297904_eng.xml

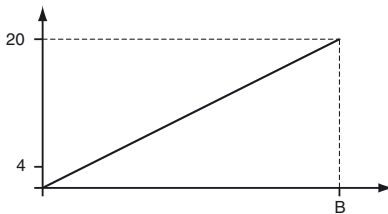
A empty -> zero start point**Reset to default settings:**

Factory setting for switching output Q1:

- Switching output inactive

Factory setting for analog output Q2:

A = 200 mm

B = 5000 mm



Value B cannot be deleted

The "zero start point" operating mode can be obtained by deleting value A

- Set the rotary switch to the "RUN" position
- Press and hold the "SET" button until the yellow and green LEDs stop flashing in phase (approx. 10 s)
- When the green LED lights up continuously, the procedure is complete.

Error messages:

- Short circuit: In the event of a short circuit at the sensor output, the green LED flashes with a frequency of approx. 4 Hz.
- Teach error: In the event of a teach error, the yellow and green LEDs flash alternately with a frequency of approx. 8 Hz.

**Note!**

The difference in the taught-in distance measured values for switching thresholds A and B must be greater than 20 mm.

If the difference in the taught-in measured values is the same as or smaller than the set switching hysteresis, the sensor will visually signal an unsuccessful Teach-In. The last distance measured value that was taught in will not be adopted by the sensor.

Select a new distance measured value for switching threshold A or B with a greater difference between the switching thresholds.

Teach in this distance measured value on the sensor again.

Switching threshold A can be deleted or set to a value of zero.

(E.g., when setting the "zero start point" curve).

However, switching threshold B can neither be deleted nor set to a value of zero.

Laser notice laser class 1

- The irradiation can lead to irritation especially in a dark environment. Do not point at people!
- Maintenance and repairs should only be carried out by authorized service personnel!
- Attach the device so that the warning is clearly visible and readable.
- Caution – Use of controls or adjustments or performance of procedures other than those specified herein may result in hazardous radiation exposure.