



**Model Number**

**QQR50M-R300-2EP-V1**

Retroreflective sensor (PRT)  
with 4-pin, M12 x 1 connector

**Features**

- Pulse Ranging Technology (PRT)
- Optimized for use with fixed reflectors
- Good alignability due to red transmission LED
- Reliable detection of reflecting metall objects

**Product information**

The sensors in the R300 series represent a versatile product line and adopt various functional principles. All sensors operate using proven Pulse Ranging Technology (PRT) and are characterized by high sensing ranges and detection ranges. Contained within the compact housing of the 28 series of light barriers, the R300 offers all of the properties of PRT such as maximum reliability when detecting objects and immunity against ambient light and cross-talk. To achieve this, the sensors in the R300 series make use of a number of different kinds of measurement data. What's more, the sensors are equipped with red light that is safe for the human eye as standard, making it easier to align the devices, even across expansive work areas. These features, combined with an innovative and intuitive operating concept, provide solutions for conventional automation tasks delivering the highest level of performance.

**Dimensions**

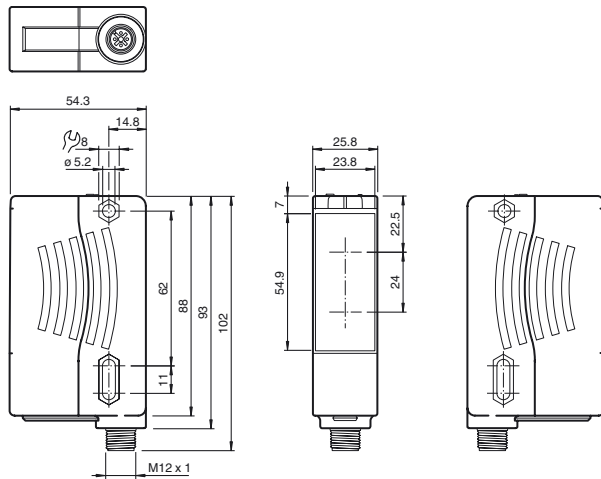

**Electrical connection**

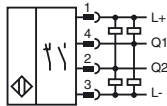

**Pinout**

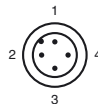

Wire colors in accordance with EN 60947-5-2

- 1 | BN (brown)
- 2 | WH (white)
- 3 | BU (blue)
- 4 | BK (black)

**Indicators/operating means**

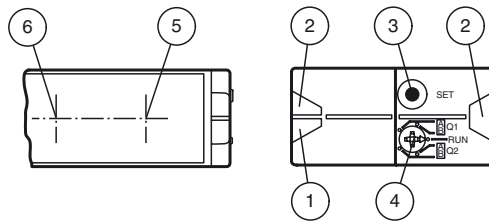

1	Operating indicator	green
2	Signal indicator	yellow
3	Teach-in push button	
4	Mode rotary switch	
5	Emitter	
6	Receiver	

Release date: 2019-04-17 08:47 Date of issue: 2019-04-17 254272\_eng.xml

Refer to "General Notes Relating to Pepperl+Fuchs Product Information".

**Technical data****General specifications**

Effective detection range	0 ... 50 m
Reflector distance	0.2 ... 50 m
Reference target	3 x REF-H100
Light source	LED
Light type	modulated visible red light
LED risk group labelling	exempt group
Angle deviation	max. $\pm 2^\circ$
Measuring method	Pulse Ranging Technology (PRT)
Diameter of the light spot	approx. 16 cm x 18 cm at a distance of 10 m
Ambient light limit	50000 Lux

**Functional safety related parameters**

MTTF <sub>d</sub>	100 a
Mission Time (T <sub>M</sub> )	10 a
Diagnostic Coverage (DC)	0 %

**Indicators/operating means**

Operation indicator	LED green
Function indicator	2 LEDs yellow for switching state
Teach-In indicator	Teach-In: LED green/yellow equiphase flashing; 2.5 Hz Teach Error: LED green/yellow non equiphase flashing; 8.0 Hz
Control elements	5-step rotary switch for operating modes selection (threshold setting and operating modes)
Control elements	Switch for setting the threshold values

**Electrical specifications**

Operating voltage	U <sub>B</sub>	10 ... 30 V DC
Ripple		10 % within the supply tolerance
No-load supply current	I <sub>0</sub>	$\leq 80$ mA / 24 V DC
Time delay before availability	t <sub>v</sub>	< 0.7 s , for temperatures < -30°C compliance of the specification 5 mins after power on

**Output**

Signal output		2 push-pull (4 in 1) outputs, short-circuit protected, reverse polarity protected
Switching voltage		max. 30 V DC
Switching current		max. 100 mA
Switching frequency	f	50 Hz
Response time		5 ms

**Conformity**

Product standard	EN 60947-5-2
------------------	--------------

**Ambient conditions**

Ambient temperature	-40 ... 55 °C (-40 ... 131 °F)
Storage temperature	-40 ... 70 °C (-40 ... 158 °F)

**Mechanical specifications**

Housing width	25.8 mm
Housing height	88 mm
Housing depth	54.3 mm
Degree of protection	IP67
Connection	4-pin, M12 x 1 connector
Material	
Housing	Plastic ABS
Optical face	PMMA
Mass	90 g

**Approvals and certificates**

UL approval	E87056 , cULus Listed , class 2 power supply , type rating 1
-------------	--

**Accessories****OMH-05**

Mounting aid for round steel  $\varnothing$  12 mm or sheet 1.5 mm ... 3 mm

**OMH-21**

Mounting bracket

**OMH-22**

Mounting bracket

**OMH-RLK29-HW**

Mounting bracket for rear wall mounting

**OMH-K01**

dove tail mounting clamp

**OMH-K03**

dove tail mounting clamp

**OMH-VDM28-01**

Metal enclosure for inserting protective panes or apertures

**OMH-VDM28-02**

Mounting and fine adjustment device for sensors from the 28 series

**OMH-07-01**

Mounting aid for round steel  $\varnothing$  12 mm or sheet 1.5 mm ... 3 mm

Other suitable accessories can be found at [www.pepperl-fuchs.com](http://www.pepperl-fuchs.com)

**Curves/Diagrams**

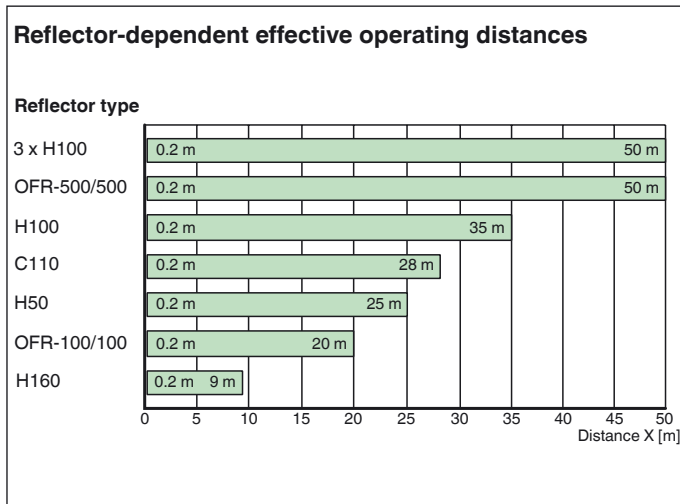

**Intended Use**

**Mounting instructions:**

The sensor can be mounted directly with thru-holes or by using a fixing bracket or mounting clamp (not included in the scope of delivery). Ensure that the surface is level in order to prevent the housing from becoming distorted when the fittings are tightened. It is advisable to secure the nuts and screws to prevent the sensor from being misaligned.

**Connection:**

Connect the device as set out in the connection diagram.

**Adjustment:**

The green LED lights up when the operating voltage is applied. Adjust the sensor so that the light spot is on the center of the reflector.

**Installation Note**

A pressure equalization membrane is fitted on the sensor nameplate. When mounting, make sure that the pressure equalization membrane is not sealed off.

**Settings**

**Teach-in:**

You can use the rotary switch to select the relevant switching threshold A and/or B for teaching in for switching signal **Q1** or **Q2**

The yellow LEDs indicate the current state of the selected output.

To teach in a switching threshold, press and hold the "SET" button until the yellow and green LEDs flash in phase (approx. 1 s). Teach-in starts when the "SET" button is released.

Successful Teach-in is indicated by the yellow and green LEDs flashing alternately (2.5 Hz). An unsuccessful Teach-in is indicated by the yellow and green LEDs rapidly flashing alternating flashing (8 Hz).

After an unsuccessful Teach-in, the sensor continues to operate with the previous valid setting after the relevant visual fault signal is issued.

Different switching modes can be defined by teaching in the relevant distance data for switching thresholds A and B.

Single-point operation:

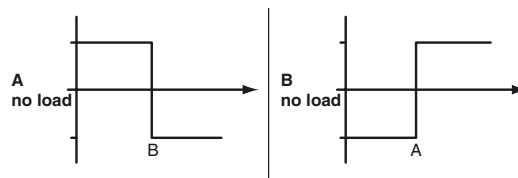

Window operation:

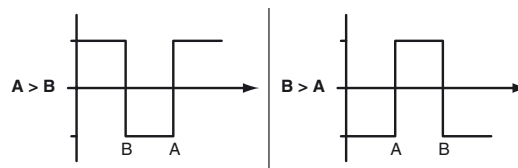

Every taught-in switching threshold can be retaught (overwritten) by pressing the "SET" button again.

A taught-in value can be reset by pressing the "SET" button for > 4 s. The yellow and green LEDs go out simultaneously to indicate that this procedure has been completed. The reset process starts when the "SET" button is released. The yellow and green LEDs flash alternately (2.5 Hz) to indicate that the reset has completed successfully.

**Reset to default settings:**

Release date: 2019-04-17 08:47 Date of issue: 2019-04-17 254272\_eng.xml

Refer to "General Notes Relating to Pepperl+Fuchs Product Information".

No switching points are set at the factory. The outputs are deactivated.

Factory settings can be restored by pressing the "SET" button for > 10 s with the rotary switch in the "Run" position. The yellow and green LEDs go out simultaneously to indicate that this procedure has been completed. The reset starts when the "SET" button is released. The green LED lights up to indicate that the reset has completed successfully. After completing the reset, the sensor will immediately function with the factory settings.