

Safety precautions to be strictly observed are marked with following symbols in the Operating Instructions:



The instruments must only be disposed of in the correct way!

Operating Instructions



Camille Bauer Metrawatt LTD
Aargauerstrasse 7
CH-5610 Wohlen/Switzerland
Phone +41 56 618 21 11
Fax +41 56 618 21 21
info@cbmag.com
www.camillebauer.com

Programmable Temperature Transmitter SINEAX V 624



V624 Be 142 159-05 05.15

Contents

1. Read first and then	1
2. Scope of supply	1
3. Brief description	1
4. Technical data	1
5. Mounting	2
6. Electrical connections	2
7. Configuring the transmitter	3
8. Commissioning	4
9. Maintenance	4
10. Releasing the transmitter	4
11. Dimensional drawings	4
12. Declaration of conformity	4

1. Read first and then ...



The proper and safe operation of the device assumes that the Operating Instructions are **read** and the safety warnings given in the various Sections

- 5. Mounting**
- 6. Electrical connections**
- 7. Configuring the transmitter**
- 8. Commissioning**

are **observed**.

The device should only be handled by appropriately trained personnel who are familiar with it and authorised to work in electrical installations. Unauthorized repair or alteration of the unit invalidates the warranty!

2. Scope of supply (Figs. 1 and 2)

Transmitter, one of the two versions (1)

Order-Code: Significance of the 1st to 4th digits

Description	Order Code
1. Housing	624 -
Housing with screw terminals, not pluggable	3
Housing with screw terminals, pluggable	9
2. Version / Power supply	
Standard/Power supply 24 ... 60 V DC, AC	1
Standard/Power supply 85 ... 230 V DC, AC	2
[Ex ia Ga] IIC and [Ex ia Da] IIIC Power supply 24 ... 60 V DC, AC	3
[Ex ia Ga] IIC and [Ex ia Da] IIIC Power supply 85...110 V DC, 85...230 V AC	4
3. Output variable	
Current (end value max. 20 mA)	1
Voltage (end value max. 10 V)	2
4. Configuration	
Basic configuration programmed	0
Configured to order	1

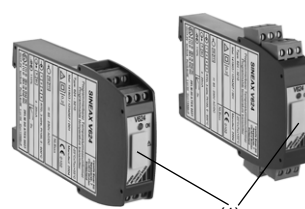

Fig. 1



Fig. 2

1 Operating Instructions (2) each in German, French and English
1 Type Examination Certificate (3), only for "Intrinsically safe" explosion-proof devices

3. Brief description

The programmable **SINEAX V624** is designed for measuring temperature in combination with thermocouples or resistance thermometers. Thermocouple non-linearities are automatically compensated.

The input variable and measuring range are programmed with the aid of a PC, a programming cable and the corresponding software. Specific measured variable data such as output signal, transmission characteristics, active direction and open-circuit sensor supervision data can also be programmed.

The sensor circuit is monitored for open and short-circuits and the output responds in a defined manner if one is detected.

Explosion-proof "Intrinsically safe" [Ex ia Ga] IIC and [Ex ia Da] IIIC versions rounds off the series of transmitters.

Transmitters supplied as standard versions are configured as follows:

- Measuring input:	Pt100 for three -wire connection
- Measuring range:	0 ... 600 °C
- Measuring output:	4 ... 20 mA resp. 0 ... 10 V, acc. to order
- Open-circuit supervision:	Output 21.6 mA resp. 11 V, acc. to order
- Mains ripple suppression:	50 Hz

4. Technical data

Measuring input Input variable and measuring range configured

Input variables	Measuring ranges		
	Limits	Min. span	Max. span
Temperatures with resistance thermometers for two , three or four -wire connection Pt100, IEC 60751	- 200 to 850 °C	50 K	850 K
Ni100, DIN 43760	- 60 to 250 °C	50 K	250 K
Temperatures with thermocouples Type B, E, J, K, N, R, S, T acc. to IEC 60584-1 Type L and U, DIN 43710 Type W5 Re/W26 Re, Type W3 Re/W25 Re acc. to ASTM E 988-90	acc. to type	2 mV	80 mV

Cold junction compensation

Internal: With incorporated Pt100
or
with Pt100 connected to the terminals

External: Via cold junction thermostat
0 ... 60 °C, configurable

Measuring output $\ominus \rightarrow$

DC current*: Configurable between
0 and 20 resp. 20 and 0 mA
minimum span 2 mA

External resistance: R_{ext} max. 600 Ω with 20 mA output

DC voltage*: Configurable between
0 and 10 resp. 10 and 0 V
minimum span 1 V

Load capacity: R_{ext} min. 2 k Ω with 10 V output

Programming connector on the transmitter

Interface: RS 232 C

Open and short-circuit sensor circuit supervision

Signalling modes: Output signal configurable to...
... the value the output had immediately prior to the open or short-circuit** (hold value)
... a value between - 5 and 110% of output span

Power supply $\rightarrow \bigcirc$

DC, AC power pack (DC or 50...400 Hz)

Rated voltages and permissible variations

Nominal voltage U_N	Tolerance	Instruments version
24 ... 60 V DC, AC	DC - 15 ... + 33%	Standard (Non-Ex)
85 ... 230 V*** DC, AC	AC \pm 15%	
24 ... 60 V DC, AC	DC - 15 ... + 33%	Type of protection "Intrinsic safety"
85 ... 230 V AC	AC \pm 15%	
85 ... 110 V DC	\pm 10%	
	- 15 ... + 10%	[Ex ia Ga] IIC
		[Ex ia Da] IIIC

Power consumption: 1.0 W resp. 2.1 VA

Light emitting diodes

Green LED: Light after switching on the power supply

Intrinsically safe

Type examination certificate: ZELM 00 ATEX 0027 and 1st supplement

Identification: Ex II (1)G [Ex ia Ga] IIC
 Ex II (1)D [Ex ia Da] IIIC

5. Mounting

The SINEAX V624 can be mounted on a top-hat rail.



When deciding where to install the transmitter (measuring location), take care that the **limits** of the operating temperature **are kept**:
-25 and + 55 °C

- * The type of output variable (current or voltage) is not configurable
** The short-circuit indicator is only active for the RTD \geq 100 Ω at 0 °C, three and four-wire measuring mode
*** Caution! Observe note in Section 6.3.

Table 1: Measuring input

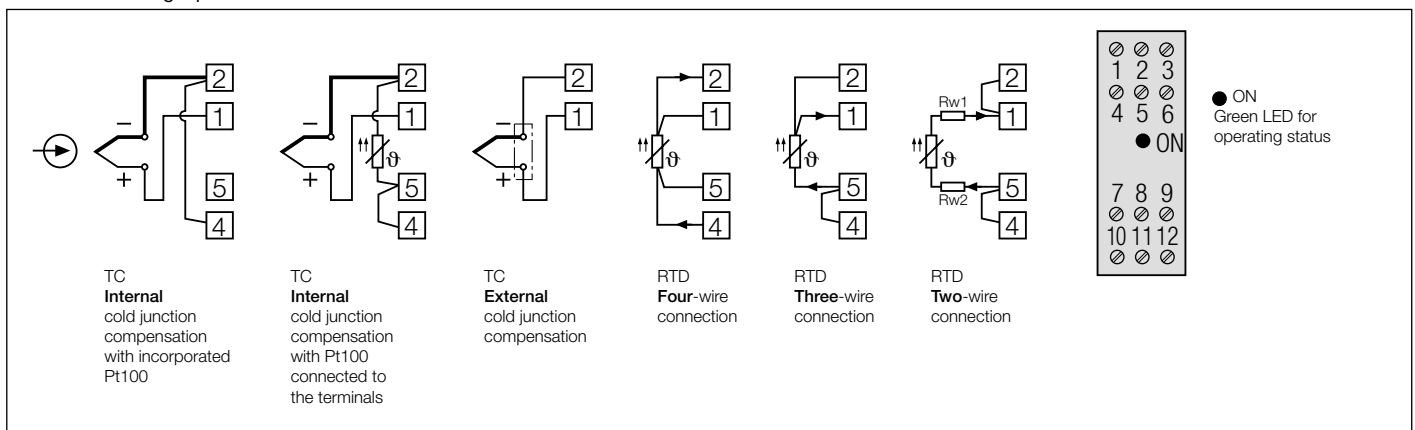

Simply clip the device onto the top-hat rail (EN 50022) (see Fig. 3).

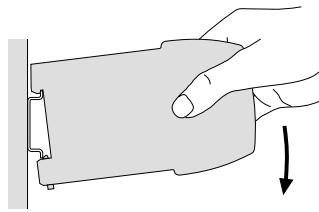

Fig. 3. Mounting onto top-hat rail 35 × 15 or 35 × 7.5 mm.

6. Electrical connections

The connections for the leads are fixed or plug-in screw terminals, depending on the device execution. These are easily accessible at the front of the transmitter and are suitable for a wire cross-section of max. 2.5 mm².



Make sure that the cables are not live when making the connections!

The 230 V power supply is potentially dangerous.



Also note that, ...

... the data required to carry out the prescribed measurement must correspond to those marked on the nameplate of SINEAX V624 ($\ominus \rightarrow$ measuring input, $\ominus \rightarrow$ measuring output and $\rightarrow \bigcirc$ power supply)!

... the resistance in the output circuit may not **overrange** the current output value

$$R_{ext} \text{ max. [k}\Omega\text{]} = \frac{12 \text{ V}}{I_{AN} \text{ [mA]}}$$

(I_{AN} = current output value)

and not **underrange** the voltage output value

$$R_{ext} \text{ min. [k}\Omega\text{]} = \frac{U_{AN} \text{ [V]}}{5 \text{ mA}}$$

(U_{AN} = voltage output value)!

... the measurement input and output cables should be twisted pairs and run as far as possible away from heavy current cables!

In all other respects, observe all local regulations when selecting the type of electrical cable and installing them!



In the case of "Intrinsically safe" explosion-proof, the supplementary information given on the type examination certificate, the EN 60079-14 and also local regulations applicable to electrical installation in explosion hazard areas must be taken into account!



6.1 Alternative measurement connections

Connect the measuring leads to suit the application as given in Table 1.

Notes:

6.1.1 Connection to thermocouples

Pay attention to correct polarity when connecting thermocouples. If the lead from the thermocouple to the transmitter has to be extended, be sure to use thermally compensated leads suitable for the particular type of thermocouple.

6.1.1.1 Internal cold junction compensation, with incorporated Pt100

Connect terminals ② and ④ when using internal compensation by comparison.

Set the configuration software to "internal thermo-element" and "Pt100 built-in".

6.1.1.2 Internal cold junction compensation with Pt100 connected to the terminals

For this alternative, a Pt100 is connected to terminals ② and ⑤. Terminals ④ and ⑤ must be connected.

Set the configuration software to "internal thermo-element" and "Pt100 on terminals".

6.1.1.3 External cold junction compensation

Be sure to configure the reference temperature when using a cold junction thermostat. The cold junction thermostat is connected to the transmitter by copper wire leads.

6.1.2 Connection to resistance thermometer

6.1.2.1 Two-wire connection

Terminals ① and ② and ④ and ⑤ must be connected in the case of a two-wire measurement.

The lead resistance must not be greater than 30 Ω per lead.

6.1.2.2 Three-wire connection

Terminals ④ and ⑤ must be connected in the case of a three-wire measurement. It is not necessary to compensate the leads, providing the three leads have identical resistances. The lead resistance must not be greater than 30 Ω per lead.

6.1.2.3 Four-wire connection

The four-wire measurement is independent of lead resistance within wide limits and therefore no compensation is necessary. The lead resistance must not be greater than 30 Ω per lead.

6.2 Measuring output leads

Connect the output leads for terminals ⑦ (-) and ⑧ (+) as shown in Fig. 4.

Note, the maximum permissible external resistance $R_{ext. max.}$ at current output, resp. $R_{ext. min.}$ at voltage output of the transmitter must not be exceeded (see Section "4. Technical data").

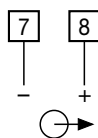

Fig. 4. Measuring output connection.

6.3 Connecting the power supply

Connect the power supply to terminals ⑩ (≈) and ⑪ (±) as shown in Fig. 5.

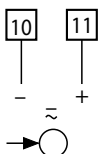

Fig. 5. Power supply connection.

A two-pole switch must be included in the supply connection where facility for switching SINEAX V624 off is desired.

Note: An external supply fuse must be provided for DC supply voltages > 125 V.

7. Configuring the transmitter

The transmitter is configured via the serial interface of a PC. An advantage of the configuration procedure is that it can be carried out regardless of whether the power supply is connected to the transmitter or not.

The following accessories are required ...

... Configuration software V 600 *plus* (Order No. 146 557)
(Download free of charge under <http://www.camillebauer.com>)

... Programming cable PK610 (Order No. 137 887)

... Ancillary cable for SINEAX type V624 (Order No. 141 416)

A PC with an RS232C interface and Windows 3.1x or higher is also required.

The configuration procedure and choice of parameters is explained by the menu-guided configuration program.

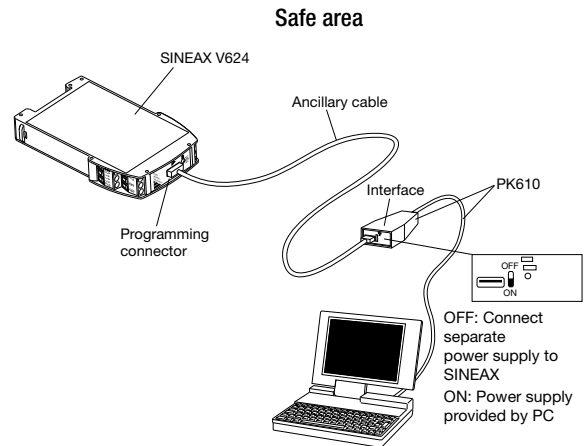

Fig. 6. Configuring a SINEAX V624 without the power supply. For this case the switch on the interface must be set to "ON".

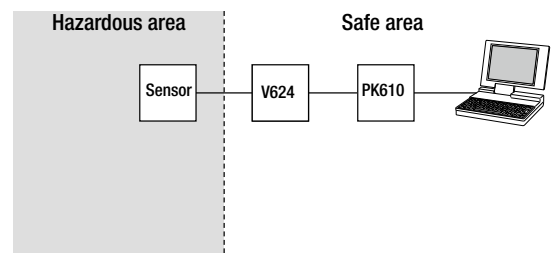

Fig. 7. Configuring the SINEAX V624, types 624-33/34/93/94, when the sensor is in the hazardous area. For this case the switch on the interface of the PK610 must be set to "ON" or "OFF", see Fig. 6.

The earthing conditions must be observed when programming the instrument, (e.g. the instrument is installed in the plant).
If one of the input wires is earthed, a PC without an earth connection must be used when programming (e.g. a notebook running on the batteries).
Under no circumstances should a PC be used running from a power supply with an earth connection, as this will damage the transducer.

For devices of the explosion protection type "intrinsically safe", the PC or laptop must support a voltage level of 500 Veff between the RS232 interface and earth (e.g. battery operation). In particular, check other peripheral devices that are connected.

If the above voltage level is not supported (e.g. operation from the mains power supply) the earth connection of the programming cable PK610 must be connected to the potential equalization conductor. At the same time, it must be ensured that the programming circuit of the V624 is potential free.

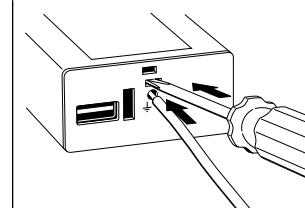

Fig. 8. Connect the earth connection to the PK610 interface.

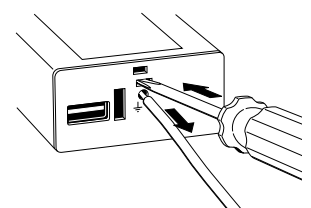



Fig. 9. Remove the earth connection from the PK610 interface.

8. Commissioning

Switch on the measuring input and the power supply.



The power supply unit must be capable of supplying a brief current surge when switching on. The transmitter presents a low impedance at the instant of switching which requires a current of I_{start} ...

... $I_{\text{start}} \approx 160 \text{ mA}$ for the version with a power supply range of 24 – 60 V DC, AC

or

... $I_{\text{start}} \approx 35 \text{ mA}$ for the version with a power supply range of 85 – 230 V DC, AC

9. Maintenance

No maintenance is required.

10. Releasing the transmitter

Release the transmitter from a top-hat rail as shown in Fig. 10.

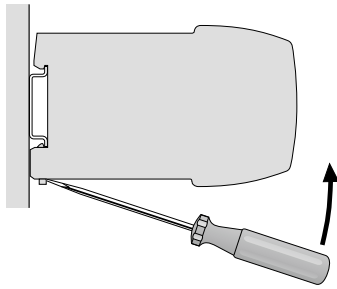

Fig. 10

11. Dimensional drawings

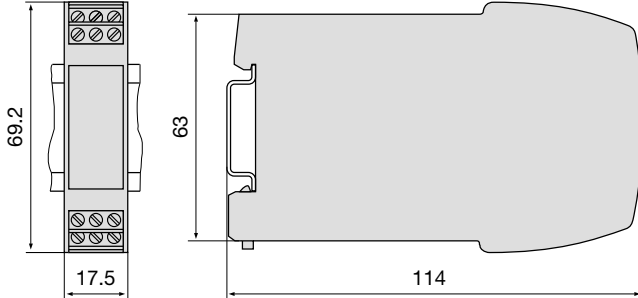

Fig. 11. SINEAX V624 in housing **P12/17** clipped onto a top-hat rail (35 × 15 mm or 35 × 7.5 mm, acc. to EN 50022), **screw terminals not pluggable**.

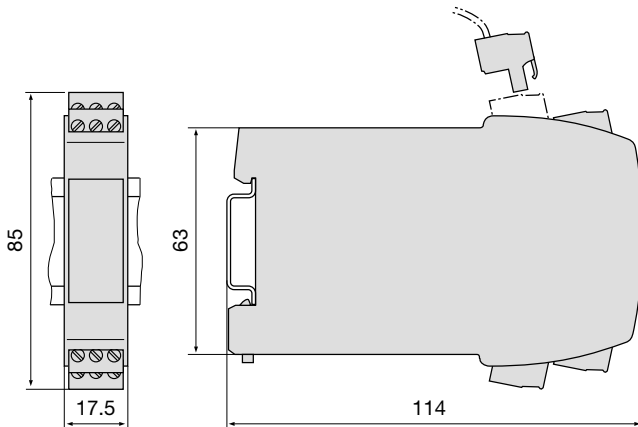

Fig. 12. SINEAX V624 in housing **P12/17 St** clipped onto a rail "G" (35 × 15 mm or 35 × 7.5 mm, acc. to EN 50022), **screw terminals pluggable**.

12. Declaration of conformity



**EG - KONFORMITÄTSERKLÄRUNG
EC DECLARATION OF CONFORMITY**



Dokument-Nr./ Document.No.: V624_CE-konf.docx
 Hersteller/ Manufacturer: **Camille Bauer Metrawatt AG**
 Switzerland
 Anschrift / Address: **Aargauerstrasse 7**
 CH-5610 Wohlen

Produktbezeichnung/ Product name: **Programmierbar Temperatur Messumformer**
 Programmable temperature Transmitter
 Typ / Type: **SINEAX V624**

Das bezeichnete Produkt stimmt mit den Vorschriften folgender Europäischer Richtlinien überein, nachgewiesen durch die Einhaltung folgender Normen:
 The above mentioned product has been manufactured according to the regulations of the following European directives proven through compliance with the following standards:

Richtlinie / Directive	2004/108/EG(CE) Elektromagnetische Verträglichkeit - EMV-Richtlinie Electromagnetic compatibility - EMC directive	
Norm / Standard	EN 61000-6-2: 2005 Fachgrundnormen - Störfestigkeit für Industriebereiche Generic standards - Immunity for industrial environments	
	EN 61000-6-4: 2007 Fachgrundnormen - Störaussendung für Industriebereiche Generic standards - Emission standard for industrial environments	
Prüfungen / Tests	IEC 61000-4-2 IEC 61000-4-3 IEC 61000-4-4 IEC 61000-4-5 IEC 61000-4-6 IEC 61000-4-11	EN 55011
Richtlinie / Directive	2006/95/EG(CE) Elektrische Betriebsmittel zur Verwendung innerhalb bestimmter Spannungsgrenzen – Niederspannungsrichtlinie – CE-Kennzeichnung : 95 Electrical equipment for use within certain voltage limits – Low Voltage Directive – Attachment of CE marking : 95	
Norm / Standard	EN 61010-1: 2010 Sicherheitsbestimmungen für elektrische Mess-, Steuer-, Regel- und Laborgeräte – Teil 1: Allgemeine Anforderungen Safety requirements for electrical equipment for measurement, control and laboratory use – Part 1: General requirements	
Die explosionsgeschützte Ausführung stimmt mit folgender Richtlinie überein: The explosion protected variant accords to the following directive:		
Richtlinie / Directive	94/9/EG(CE) Geräte und Schutzsysteme zur bestimmungsgemäßen Verwendung in explosionsgefährdeten Bereichen Equipment and protective systems intended for use in potentially explosive atmospheres	
Norm / Standard	EN 60079-0: 2009 / -11: 2012 / -26: 2007 Explosionsfähige Atmosphäre / Explosive atmospheres – - 0: Geräte - Allgemeine Anforderungen / General requirements - 11: Geräteschutz durch Eigensicherheit "I" / Equipment protection by intrinsic safety "I" - 26: Betriebsmittel mit Geräteschutzniveau (EPL) Ga / Equipment with equipment protection level (EPL) Ga	
Nachweis / Proof	ZELM 00 ATEX 0027 Notified Body No. 0102: PTB D-35119 Braunschweig,	

Ort, Datum / Place, date: Wohlen, 17. April 2015
 Unterschrift / signature:

M. Ulrich 
 Leiter Technik / Head of engineering

J. Brem 
 Qualitätsmanager / Quality manager