

Modular timers

1 - 6 - 8 - 16 A

80
SERIES



Building automation



Elevators and lifts



Automation for blinds, grilles and shutters



Hoists and cranes



Panels for electrical distribution



Door and gate openers



Multi-function and mono-function timer range

- 80.01 - Multi-function & multi-voltage**
- 80.11 - On-delay, multi-voltage**

- 17.5 mm wide
- Six time scales from 0.1 s to 24 h
- High input/output isolation
- 35 mm rail (EN 60715) mount
- "Blade + cross" - both flat blade and cross head screw drivers can be used to adjust the range and function selectors, the timing trimmer, and to disengage the rail mounting clip
- New multi-voltage versions with "PWM clever" technology

80.01 / 80.11
Screw terminal



FOR UL RATINGS SEE:

"General technical information" page V

For outline drawing see page 9

Contact specification

Contact configuration		1 CO (SPDT)	1 CO (SPDT)
Rated current/Maximum peak current	A	16/30	16/30
Rated voltage/ Maximum switching voltage	V AC	250/400	250/400
Rated load AC1	VA	4000	4000
Rated load AC15 (230 V AC)	VA	750	750
Single phase motor rating (230 V AC)	kW	0.55	0.55
Breaking capacity DC1: 30/110/220 V	A	16/0.3/0.12	16/0.3/0.12
Minimum switching load	mW (V/mA)	500 (10/5)	500 (10/5)
Standard contact material		AgNi	AgNi

Supply specification

Nominal voltage (U _N)	V AC (50/60 Hz)	12...240	24...240
	V DC	12...240	24...240
Rated power AC/DC	VA (50 Hz)/W	< 1.8/< 1	< 1.8/< 1
Operating range	V AC	10.8...265	16.8...265
	V DC	10.8...265	16.8...265

Technical data

Specified time range		(0.1...2)s, (1...20)s, (0.1...2)min, (1...20)min, (0.1...2)h, (1...24)h	
Repeatability	%	± 1	± 1
Recovery time	ms	100	100
Minimum control impulse	ms	50	—
Setting accuracy-full range	%	± 5	± 5
Electrical life at rated load in AC1	cycles	50 · 10 ³	50 · 10 ³
Ambient temperature range	°C	-20...+60	-20...+60
Protection category		IP 20	IP 20

Approvals (according to type)

80.01



- Multi-voltage
- Multi-function

- AI:** On-delay
DI: Interval
SW: Symmetrical flasher (starting pulse on)
BE: Off-delay with control signal
CE: On- and off-delay with control signal
DE: Interval with control signal on

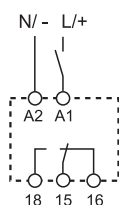

Wiring diagram
(without control signal)

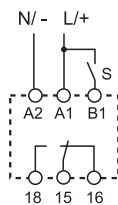

Wiring diagram
(with control signal)

80.11



- Multi-voltage
- Mono-function

- AI:** On-delay

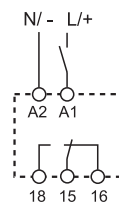

Wiring diagram
(without control signal)

Mono-function timer range**80.21 - Interval, multi-voltage****80.41 - Off-delay with control signal, multi-voltage****80.91 - Asymmetrical flasher, multi-voltage**

- 17.5 mm wide
- Six time scales from 0.1 s to 24 h
- High input/output isolation
- 35 mm rail (EN 60715) mount
- "Blade + cross" - both flat blade and cross head screw drivers can be used to adjust the range and function selectors, the timing trimmer, and to disengage the rail mounting clip
- New multi-voltage versions with "PWM clever" technology

80.21 / 80.41 / 80.91

Screw terminal



FOR UL RATINGS SEE:

"General technical information" page V

For outline drawing see page 9

Contact specification

		80.21	80.41	80.91
Contact configuration		1 CO (SPDT)	1 CO (SPDT)	1 CO (SPDT)
Rated current/Maximum peak current	A	16/30	16/30	16/30
Rated voltage/ Maximum switching voltage	V AC	250/400	250/400	250/400
Rated load AC1	VA	4000	4000	4000
Rated load AC15 (230 V AC)	VA	750	750	750
Single phase motor rating (230 V AC)	kW	0.55	0.55	0.55
Breaking capacity DC1: 30/110/220 V	A	16/0.3/0.12	16/0.3/0.12	16/0.3/0.12
Minimum switching load	mW (V/mA)	500 (10/5)	500 (10/5)	500 (10/5)
Standard contact material		AgNi	AgNi	AgNi

Supply specification

Nominal voltage (U _N)	V AC (50/60 Hz)	24...240	24...240	12...240
	V DC	24...240	24...240	12...240
Rated power AC/DC	VA (50 Hz)/W	< 1.8/< 1	< 1.8/< 1	< 1.8/< 1
Operating range	V AC	16.8...265	16.8...265	10.8...265
	V DC	16.8...265	16.8...265	10.8...265

Technical data

Specified time range		(0.1...2)s, (1...20)s, (0.1...2)min, (1...20)min, (0.1...2)h, (1...24)h		
Repeatability	%	± 1	± 1	± 1
Recovery time	ms	100	100	100
Minimum control impulse	ms	—	50	50
Setting accuracy-full range	%	± 5	± 5	± 5
Electrical life at rated load in AC1	cycles	50 · 10 ³	50 · 10 ³	50 · 10 ³
Ambient temperature range	°C	-20...+60	-20...+60	-20...+60
Protection category		IP 20	IP 20	IP 20

Approvals (according to type)**80.21**

- Multi-voltage
- Mono-function

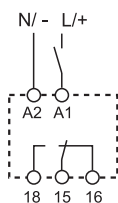
DI: IntervalWiring diagram
(without control signal)**80.41**

- Multi-voltage
- Mono-function

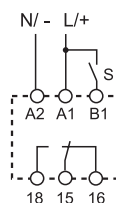
BE: Off-delay with control signalWiring diagram
(with control signal)**80.91**

- Multi-voltage
- Mono-function

LI: Asymmetrical flasher
(starting pulse on)
LE: Asymmetrical flasher (starting pulse on) with control signal

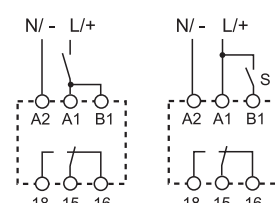
Wiring diagram
(without control signal) Wiring diagram
(with control signal)

Multi-function and multi-voltage solid-state output timer

- 17.5 mm wide
- Six time scales from 0.1 s to 24 h
- High input/output isolation
- 35 mm rail (EN 60715) mount
- Multi-voltage output (24...240 V AC/DC), independent from the input voltage
- "Blade + cross" - both flat blade and cross head screw drivers can be used to adjust the range and function selectors, the timing trimmer, and to disengage the rail mounting clip
- Multi-voltage input with "PWM clever" technology

80.71
Screw terminal



For outline drawing see page 9

Output circuit

Contact configuration	1 NO (SPST-NO)	
Rated current	A	1
Rated voltage	V AC/DC	24...240
Switching voltage range	V AC/DC	19...265
Rated load AC15	A	1
Rated load DC1	A	1
Minimum switching current	mA	0.5
Max. "OFF-state" leakage current	mA	0.05
Max. "ON-state" voltage drop	V	2.8

Input circuit

Nominal voltage (U _N)	V AC (50/60 Hz)	24...240
	V DC	24...240
Rated power	VA (50 Hz)/W	1.3/1.3
Operating range	V AC	19...265
	V DC	19...265

Technical data

Specified time range	(0.1...2)s, (1...20)s, (0.1...2)min, (1...20)min, (0.1...2)h, (1...24)h	
Repeatability	%	± 1
Recovery time	ms	100
Minimum control impulse	ms	50
Setting accuracy-full range	%	± 5
Electrical life	cycles	100 · 10 ⁶
Ambient temperature range	°C	-20...+50
Protection category	IP 20	

Approvals (according to type)



80.71



- Multi-voltage
- Multi-function

- AI:** On-delay
DI: Interval
SW: Symmetrical flasher (starting pulse on)
BE: Off-delay with control signal
CE: On- and off-delay with control signal
DE: Interval with control signal on

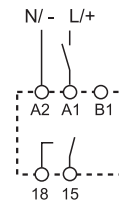

Wiring diagram
(without control signal)

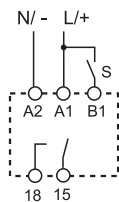

Wiring diagram
(with control signal)

Mono-function timer range
80.61 - Power off-delay (True off-delay), multi-voltage
80.82 - Star-delta, multi-voltage

- 17.5 mm wide
- Rotary range selector, and timing trimmer
- Four time scales from 0.05s to 180 s (type 80.61)
- Six time scales from 0.1 s to 20min (type 80.82)
- High input/output isolation
- 35 mm rail (EN 60715) mount

 80.61 / 80.82
Screw terminal
**80.61**

- Multi-voltage
- Mono-function

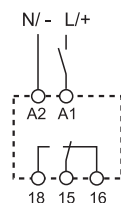
BI: Power off-delay (True off-delay)

 Wiring diagram
(without control signal)
80.82

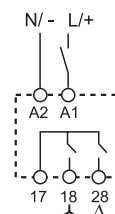
- Multi-voltage
- Mono-function
- Transfer time can be regulated (0.05...1)s

SD: Star-delta

 Wiring diagram
(without control signal)

FOR UL RATINGS SEE:

"General technical information" page V

For outline drawing see page 9

Contact specification

Contact configuration		1 CO (SPDT)	2 NO (DPST-NO)
Rated current/Maximum peak current	A	8/15	6/10
Rated voltage/ Maximum switching voltage	V AC	250/400	250/400
Rated load AC1	VA	2000	1500
Rated load AC15 (230 V AC)	VA	400	300
Single phase motor rating (230 V AC)	kW	0.3	—
Breaking capacity DC1: 30/110/220 V	A	8/0.3/0.12	6/0.2/0.12
Minimum switching load	mW (V/mA)	300 (5/5)	500 (12/10)
Standard contact material		AgNi	AgNi

Supply specification

Nominal voltage (U _N)	V AC (50/60 Hz)	24...240	24...240
	V DC	24...220	24...240
Rated power AC/DC	VA (50 Hz)/W	< 0.6/< 0.6	< 1.3/< 0.8
Operating range	V AC	16.8...265	16.8...265
	V DC	16.8...242	16.8...265

Technical data

Specified time range		(0.05...2)s, (1...16)s, (8...70)s, (50...180)s	(0.1...2)s, (1...20)s, (0.1...2)min, (1...20)min
Repeatability	%	± 1	± 1
Recovery time	ms	—	100
Minimum control impulse	ms	500 (A1-A2)	—
Setting accuracy-full range	%	± 5	± 5
Electrical life at rated load in AC1	cycles	100 · 10 ³	60 · 10 ³
Ambient temperature range	°C	-20...+60	-20...+60
Protection category		IP 20	IP 20

Approvals (according to type)

Multi-function and multi-voltage

- 17.5 mm wide
- Six time scales from 0.1 s to 24 h
- High input/output isolation
- 35 mm rail (EN 60715) mount
- "Blade + cross" - both flat blade and cross head screw drivers can be used to adjust the range and function selectors, the timing trimmer, and to disengage the rail mounting clip
- New multi-voltage versions with "PWM clever" technology

80.51.0.240.0000
Screw terminal

80.51.0.240.P000
Push-in terminal



FOR UL RATINGS SEE:

"General technical information" page V

For outline drawing see page 9

Contact specification

Contact configuration	
Rated current/Maximum peak current	A
Rated voltage/ Maximum switching voltage	V AC
Rated load AC1	VA
Rated load AC15 (230 V AC)	VA
Single phase motor rating (230 V AC)	kW
Breaking capacity DC1: 30/110/220 V	A
Minimum switching load	mW (V/mA)
Standard contact material	

Supply specification

Nominal voltage (U _N)	V AC (50/60 Hz)
	V DC
Rated power AC/DC	VA (50 Hz)/W
Operating range	V AC
	V DC

Technical data

Specified time range	
Repeatability	%
Recovery time	ms
Minimum control impulse	ms
Setting accuracy-full range	%
Electrical life at rated load in AC1	cycles
Ambient temperature range	°C
Protection category	

Approvals (according to type)



- Multi-voltage (24...240) V AC/DC
- Multi-function

- AI:** On-delay
DI: Interval
SW: Symmetrical flasher (starting pulse on)
BE: Off-delay with control signal
CE: On- and off-delay with control signal
DE: Interval with control signal on

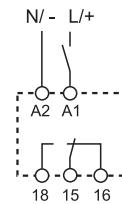

Wiring diagram
(without control signal)

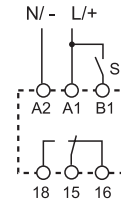

Wiring diagram
(with control signal)

Approvals (according to type)

Ordering information

Example: 80 series, modular timers, 1 CO (SPDT) - 16 A, supply rated at (12...240)V AC/DC.

8 0 . 0 1 . 0 . 2 4 0 . 0 0 0 0

Series

Type

- 0 = Multi-function (AI, DI, SW, BE, CE, DE)
- 1 = On-delay (AI)
- 2 = Interval (DI)
- 4 = Off-delay with control signal (BE)
- 5 = Multi-function (AI, DI, SW, BE, CE, DE)
- 6 = Power off-delay (True off-delay) (BI)
- 7 = Multi-function with solid state output (AI, DI, SW, BE, CE, DE)
- 8 = Star-delta (SD)
- 9 = Asymmetrical flasher (LI, LE)

Versions

- 0 = Standard
- P = Push-in (only for 80.51)

Supply voltage

- 240 = (12...240)V AC/DC (80.01, 80.91)
- 240 = (24...240)V AC/DC (80.11, 80.21, 80.41, 80.51, 80.71, 80.82)
- 240 = (24...240)V AC, (24...220)V DC (80.61)

Supply version

- 0 = AC (50/60 Hz)/DC

No. of poles

- 1 = 1 CO (SPDT)
- 1 = 1 NO (SPST-NO), type 80.71 only
- 2 = 2 NO (DPST-NO), type 80.82 only

Technical data

Insulation

			80.01/11/21/41/51/82/91	80.61	80.71
Dielectric strength	between input and output circuit	V AC	4000	2500	2500
	between open contacts	V AC	1000	1000	—
Insulation (1.2/50 μs) between input and output		kV	6	4	4

EMC specifications

Type of test		Reference standard	80.01/11/21/41/61/71/91	80.51/82
Electrostatic discharge	contact discharge	EN 61000-4-2	4 kV	4 kV
	air discharge	EN 61000-4-2	8 kV	8 kV
Radio-frequency electromagnetic field (80 ÷ 1000 MHz)		EN 61000-4-3	10 V/m	10 V/m
Fast transients (burst) (5-50 ns, 5 kHz) on Supply terminals		EN 61000-4-4	4 kV	4 kV
Surges (1.2/50 μs) on Supply terminals	common mode	EN 61000-4-5	4 kV	4 kV
	differential mode	EN 61000-4-5	4 kV	4 kV
	common mode	EN 61000-4-5	4 kV	4 kV
	differential mode	EN 61000-4-5	4 kV	4 kV
Radio-frequency common mode (0.15 ÷ 80 MHz) on Supply terminals		EN 61000-4-6	10 V	10 V
Radiated and conducted emission		EN 55022	class B	class A

Other data

Current absorption on signal control (B1)			< 1 mA
Power lost to the environment	without contact current	W	1.4
	with rated current	W	3.2

Terminals

			Screw terminals	Push-in terminals
Wire strip length	mm		10	10
 Screw torque	Nm		0.8	—
Min. wire size			solid cable	solid cable
	mm ²		0.5	0.75
	AWG		20	18
Max. wire size			solid cable	solid cable
	mm ²		1 x 6 / 2 x 4	1 x 1.5 / 2 x 1.5
	AWG		1 x 10 / 2 x 12	1 x 16 / 2 x 16
Min. wire size			stranded cable	stranded cable
	mm ²		0.5	0.75
	AWG		20	18
Max. wire size			stranded cable	stranded cable
	mm ²		1 x 4 / 2 x 2.5	1 x 2.5 / 2 x 2.5
	AWG		1 x 12 / 2 x 14	1 x 14 / 2 x 14

Outline drawings

Types 80.01/80.51
Screw terminal

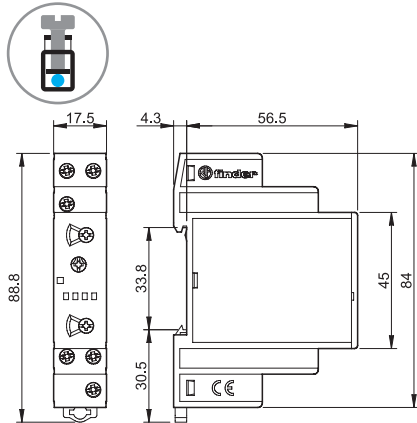

Type 80.51
Push-in terminal

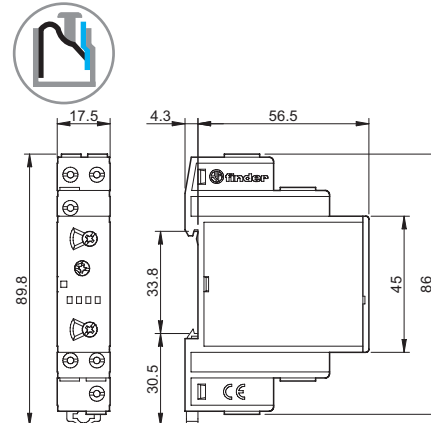

Types 80.11/80.21/80.61
Screw terminal

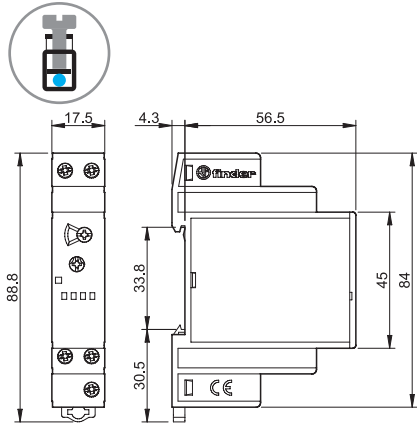

Type 80.41
Screw terminal

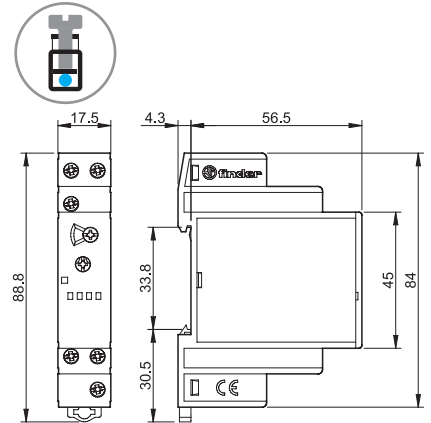

Type 80.91
Screw terminal

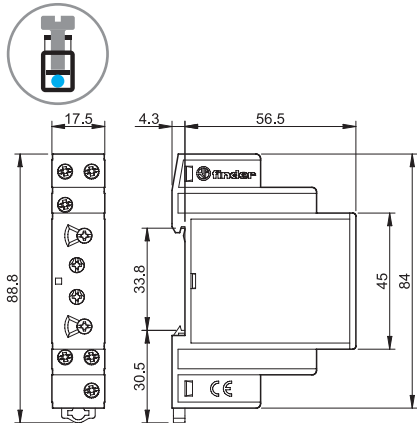

Type 80.71
Screw terminal

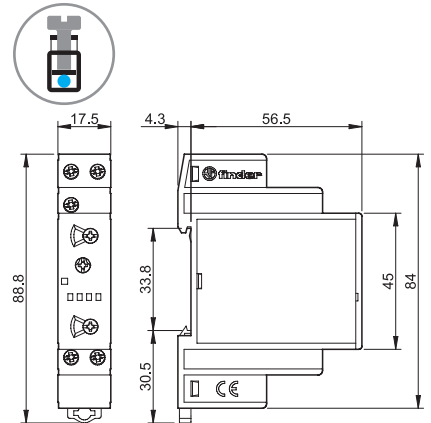

Type 80.82
Screw terminal

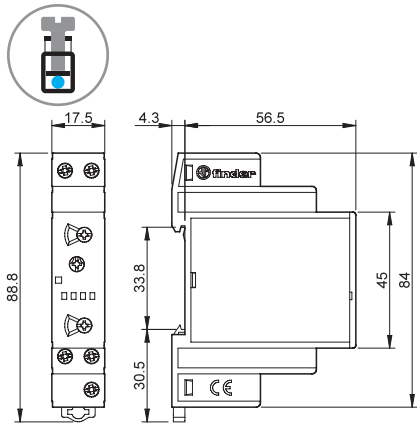

IX-2021, www.findernet.com

H

Functions

- U** = Supply voltage
- S** = Signal switch
- = Output contact

LED*	Supply voltage	NO output contact	Contacts	
			Open	Closed
	OFF	Open	15 - 18	15 - 16
	ON	Open	15 - 18	15 - 16
	ON	Open (Timing in Progress)	15 - 18	15 - 16
	ON	Closed	15 - 16	15 - 18

* The LED on type 80.61 is illuminated only when the supply voltage is applied to the timer; during the timing period the LED is not illuminated.

Without control signal = Start via contact in supply line (A1).
With control signal = Start via contact into control terminal (B1).

Wiring diagram

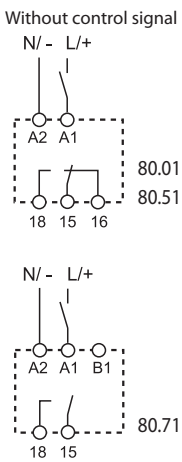

Type
80.01
80.51
80.71

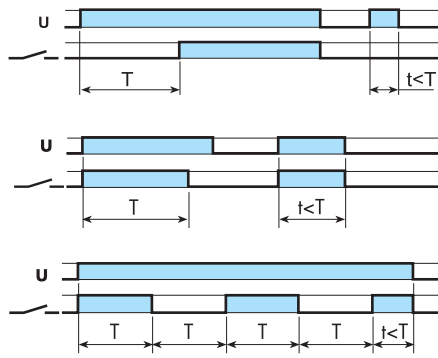

- (AI) On-delay.**
Apply power to timer. Output contacts transfer after preset time has elapsed. Reset occurs when power is removed.
- (DI) Interval.**
Apply power to timer. Output contacts transfer immediately. After the preset time has elapsed, contacts reset.
- (SW) Symmetrical flasher (starting pulse on).**
Apply power to timer. Output contacts transfer immediately and cycle between ON and OFF for as long as power is applied. The ratio is 1:1 (time on = time off).

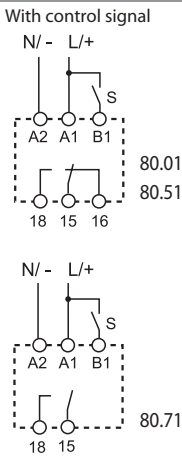

80.01
80.51
80.71

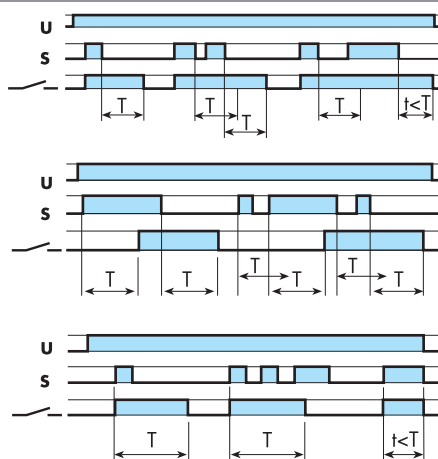

- (BE) Off-delay with control signal.**
Power is permanently applied to the timer. The output contacts transfer immediately on closure of the Signal Switch (S). Opening the Signal Switch initiates the preset delay, after which time the output contacts reset.
- (CE) On- and off-delay with control signal.**
Power is permanently applied to the timer. Closing the Signal Switch (S) initiates the preset delay, after which time the output contacts transfer. Opening the Signal switch initiates the same preset delay, after which time the output contacts reset.
- (DE) Interval with control signal on.**
Power is permanently applied to the timer. On momentary or maintained closure of Signal Switch (S), the output contacts transfer, and remain so for the duration of the preset delay, after which they reset.

NOTE: The function must be set before energising the timer.

- Possible to control an external load, such as another relay coil or timer, connected to the control signal terminal B1.

* With DC supply, positive polarity has to be connected to B1 terminal (according to EN 60204-1).

** A voltage other than the supply voltage can be applied to the command Start (B1), example:
A1 - A2 = 230 V AC
B1 - A2 = 12 V DC

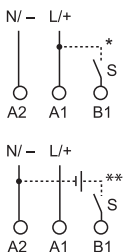
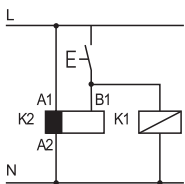

Functions

Wiring diagram

<p>Without control signal</p> <p>80.11/21/61</p> <p>80.82</p>	<p>Type</p> <p>80.11</p> <p>80.21</p> <p>80.61</p> <p>80.82</p>		<p>(AI) On-delay. Apply power to timer. Output contacts transfer after preset time has elapsed. Reset occurs when power is removed.</p> <p>(DI) Interval. Apply power to timer. Output contacts transfer immediately. After the preset time has elapsed, contacts reset.</p> <p>(BI) Power off-delay (True off-delay). Apply power to timer (minimum 500 ms). Output contacts transfer immediately. Removal of power initiates the preset delay, after which time the output contacts reset.</p> <p>(SD) Star-delta. Apply power to timer. The star contact (Λ) closes immediately. After preset delay has elapsed the star contact (Λ) resets. After a further transfer time variable from (0.05...1)s the delta contact (Δ) closes and remains in that position, until reset on power off.</p>
<p>With control signal</p> <p>80.41</p>	<p>80.41</p>		<p>(BE) Off-delay with control signal. Power is permanently applied to the timer. The output contacts transfer immediately on closure of the Signal Switch (S). Opening the Signal Switch initiates the preset delay, after which time the output contacts reset.</p>
<p>Without control signal</p> <p>80.91</p> <p>With control signal</p> <p>80.91</p>	<p>80.91</p>		<p>(LI) Asymmetrical flasher (starting pulse on). Apply power to timer. Output contacts transfer immediately and cycle between ON and OFF for as long as power is applied. The ON (T₁) and OFF (T₂) times are independently adjustable.</p> <p>(LE) Asymmetrical flasher (starting pulse on) with control signal Power is permanently applied to the timer. Closing Signal Switch (S) causes the output contacts to transfer immediately and cycle between ON (T₁) and OFF (T₂), until opened.</p>

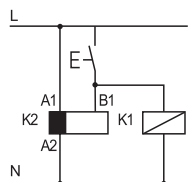

• Possible to control an external load, such as another relay coil or timer, connected to the control signal terminal B1.

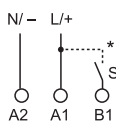

* With DC supply, positive polarity has to be connected to B1 terminal (according to EN 60204-1).

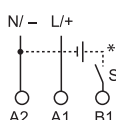

** A voltage other than the supply voltage can be applied to the command Start (B1), example:

A1 - A2 = 230 V AC
B1 - A2 = 12 V DC

Times scales

Rotary switch position series 80

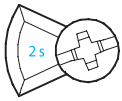

(0.1...2)s

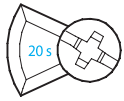

(1...20)s

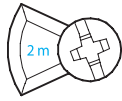

(0.1...2)min

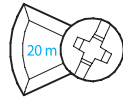

(1...20)min

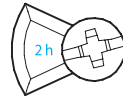

(0.1...2)h

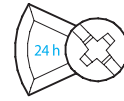

(1...24)h

Accessories

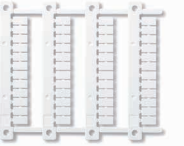

060.48

Sheet of marker tags (CEMBRE Thermal transfer printers) for relays types
80.01/11/21/41/51/61/71 (48 tags), 6 x 12 mm

060.48