

Data sheet | Item number: 2604-3102

PCB terminal block; lever; 4 mm²; Pin spacing 5 mm; 2-pole; Push-in CAGE CLAMP®; 4,00 mm²; gray

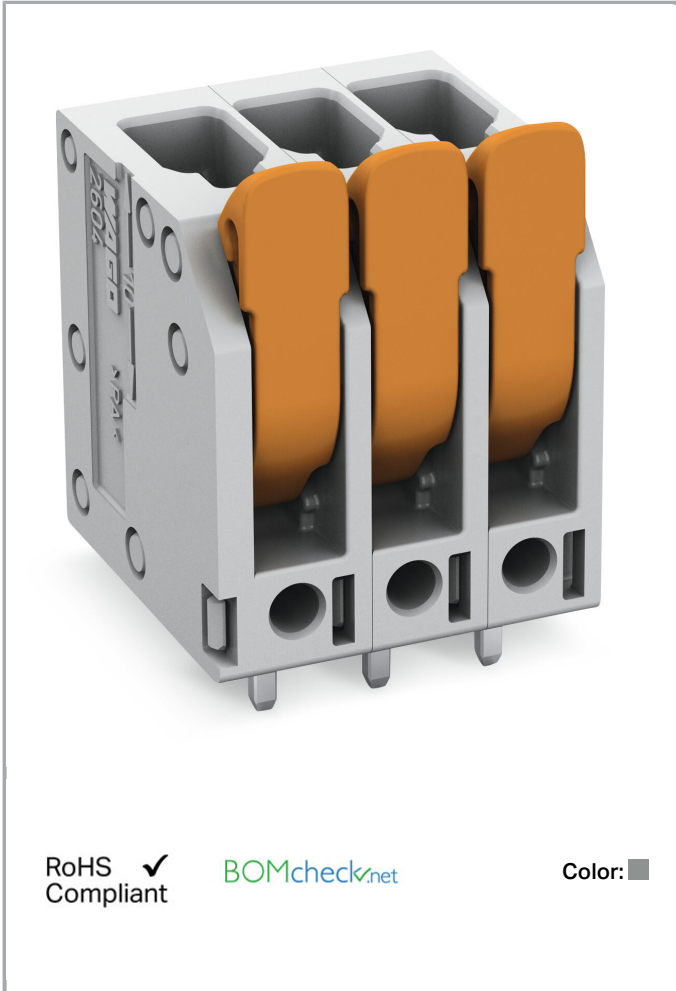

www.wago.com/2604-3102



RoHS Compliant

[BOMcheck.net](https://www.bomcheck.net)

Color: ■

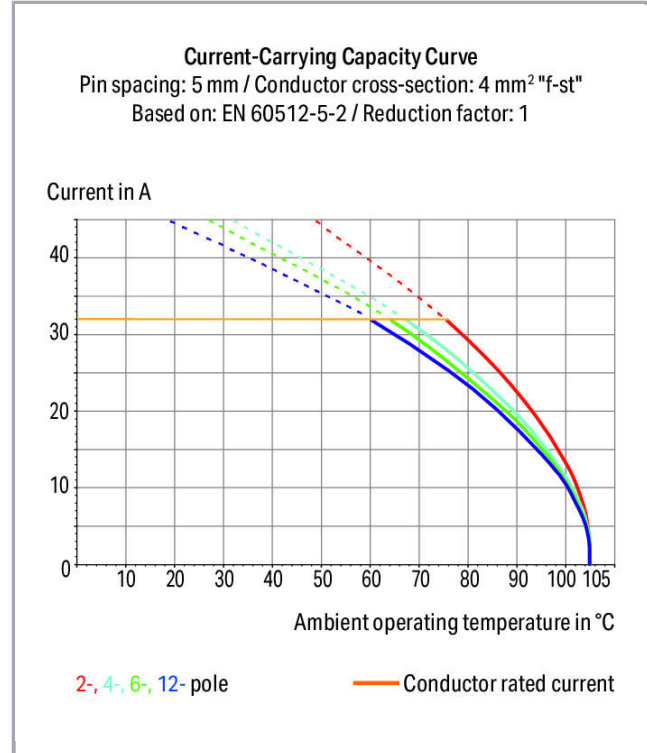

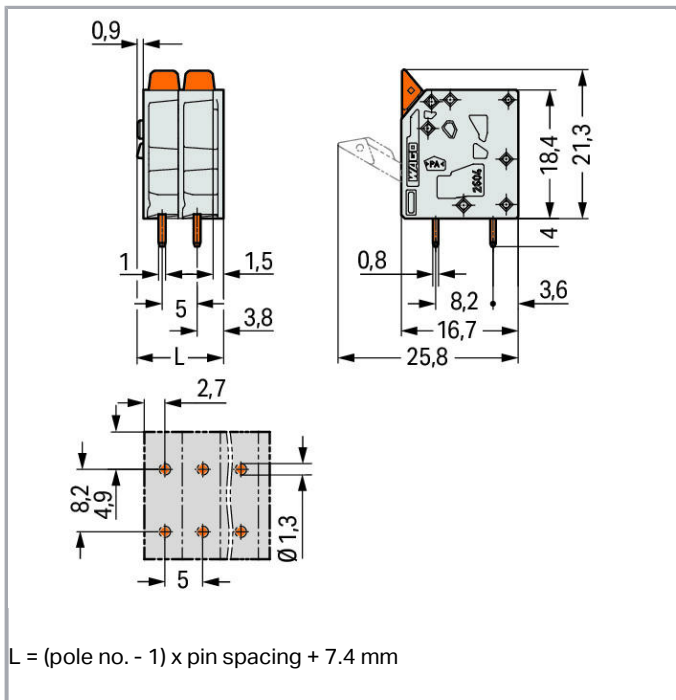

Item description

- PCB terminal strips with lever-actuated Push-in CAGE CLAMP® connection
- Push-in termination of solid and ferruled conductors
- Intuitive and tool-free operation
- Several clamping units can be held open simultaneously – convenient for terminating multi-core cables
- Testing can be performed both parallel and perpendicular to conductor entry

Data

Electrical data

Ratings per IEC/EN 60664-1

Rated voltage (III / 3)	320 V
Rated impulse voltage (III / 3)	4 kV
Rated voltage (III / 2)	400 V
Rated impulse voltage (III / 2)	4 kV
Rated voltage (II / 2)	630 V
Rated impulse voltage (II / 2)	4 kV
Rated current	32 A
Legend (ratings)	(III / 2) ≙ Overvoltage category III / Pollution degree 2

Approvals per UL 1059

Rated voltage UL (Use Group B)	300 V
Rated current UL (Use Group B)	20 A



Rated voltage UL (Use Group D)	300 V
Rated current UL (Use Group D)	10 A

Connection data

Connection technology	Push-in CAGE CLAMP®
Actuation type	Lever
Solid conductor	0.2 ... 4 mm ² / 24 ... 12 AWG
Fine-stranded conductor	0.2 ... 4 mm ² / 24 ... 12 AWG
Fine-stranded conductor with ferrule with plastic collar	0.25 ... 2.5 mm ²
Fine-stranded conductor with ferrule without plastic collar	0.25 ... 2.5 mm ²
Fine-stranded conductor, with twin ferrule	0.25 ... 1.5 mm ²
Strip length	9 ... 11 mm / 0.35 ... 0.43 inch
Conductor entry angle to the PCB	90°
No. of poles	2
Total number of connection points	2
Total number of potentials	2
Number of connection types	1
Number of levels	1

Geometrical Data

Pin spacing	5 mm / 0.197 inch
Width	12.4 mm / 0.488 inch
Height	25.3 mm / 0.996 inch
Height from the surface	21.3 mm / 0.839 inch
Depth	16.7 mm / 0.657 inch
Solder pin length	4 mm
Solder pin dimensions	0.8 x 1 mm
Drilled hole diameter (tolerance)	1.3 ^(- ... +0.1) mm

PCB contact

PCB contact	THT
Solder pin arrangement	over the entire terminal strip, in line
Number of solder pins per potential	2

Material Data

Color	gray
Material group	I
Insulating material	Polyamide 66 (PA 66)
Flammability class per UL94	V0



Clamping spring material	Chrome nickel spring steel (CrNi)
Contact material	Electrolytic copper (E _{Cu})
Contact plating	tin-plated
Actuating element color	orange
Weight	3.584 g

Environmental Requirements



Limit temperature range	-60 ... +105 °C
-------------------------	-----------------

Commercial data

Packaging type	BOX
Country of origin	DE
GTIN	4055143564717
Customs Tariff No.	85369010000

Approvals / Certificates

Country specific Approvals







Logo	Approval	Additional Approval Text	Certificate name
	CB DEKRA Certification B.V.	EN 60947-7-4	NL-47057
	CSA DEKRA Certification B.V.	C22.2 No. 158	70117145
	KEMA/KEUR DEKRA Certification B.V.	EN 60947-7-4	71-100535

UL-Approvals

Logo	Approval	Additional Approval Text	Certificate name
	cURus Underwriters Laboratories Inc.	UL 1059	E45172 sec. 71

Compatible products

ferrule

	Item no.: 216-106 Ferrule; Sleeve for 2.5 mm ² / AWG 14; uninsulated; electro-tin plated	www.wago.com/216-106
	Item no.: 216-241 Ferrule; Sleeve for 0.5 mm ² / 20 AWG; insulated; electro-tin plated; electrolytic copper; gastight crimped; acc. to DIN 46228, Part 4/09.90; white	www.wago.com/216-241
	Item no.: 216-242 Ferrule; Sleeve for 0.75 mm ² / 18 AWG; insulated; electro-tin plated; electrolytic copper; gastight crimped; acc. to DIN 46228, Part 4/09.90; gray	www.wago.com/216-242
	Item no.: 216-243 Ferrule; Sleeve for 1 mm ² / AWG 18; insulated; electro-tin plated; electrolytic copper; gastight crimped; acc. to DIN 46228, Part 4/09.90; red	www.wago.com/216-243
	Item no.: 216-244 Ferrule; Sleeve for 1.5 mm ² / AWG 16; insulated; electro-tin plated; electrolytic copper; gastight crimped; acc. to DIN 46228, Part 4/09.90; black	www.wago.com/216-244
	Item no.: 216-246 Ferrule; Sleeve for 2.5 mm ² / AWG 14; insulated; electro-tin plated; electrolytic copper; gastight crimped; acc. to DIN 46228, Part 4/09.90; blue	www.wago.com/216-246

Downloads

Documentation

Additional Information

Technical explanations	Apr 3, 2019	pdf 3.6 MB	Download
------------------------	-------------	---------------	----------

CAD/CAE-Data

CAD data

2D/3D Models 2604-3102	URL	Download
------------------------	-----	----------

PCB

Symbol and Footprint 2604-3102	URL	Download
--------------------------------	-----	----------

Handling Instructions

Subject to changes.

WAGO Kontakttechnik GmbH & Co. KG
 Hansastr. 27
 32423 Minden
 Phone: +49571 887-0 | Fax: +49571 887-169
 Email: info.de@wago.com | Web: www.wago.com

Do you have any questions about our products?
 We are always happy to take your call at +49 (571) 887-44222.