



MONOPRICE

MP10 3D Printer



P/N 34437, 34577, 34578

User's Manual

CONTENTS

SAFETY WARNINGS AND GUIDELINES	3
INTRODUCTION.....	4
FEATURES.....	4
CUSTOMER SERVICE.....	5
PACKAGE CONTENTS	5
PRODUCT OVERVIEW	6
INSTALLATION.....	8
SETUP	10
ASSISTED LEVELING	13
GLOBAL Z OFFSET LIVE LEVEL	15
OPTIONAL WI-FI SETUP	15
SOFTWARE INSTALLATION AND SETUP	17
Installing Cura	17
Repetier-Host.....	20
TECHNICAL SUPPORT	22
REGULATORY COMPLIANCE.....	22
Notice for FCC.....	22
EU Declaration of Conformity	23
WEEE Information	24
Safety Notice.....	25

SAFETY WARNINGS AND GUIDELINES

- Be careful not to damage the PC paper on the build plate.
- Take care to avoid touching hot parts, including heat blocks, extruder nozzle, extruded filament, and the heated build plate.
- Do not wear gloves when operating or repairing to avoid entanglement.
- Keep the printer and all accessories out of reach of children.
- Do not remove or disconnect the USB cable when printing from a computer.
- Do not pull or twist the black cable at any time.
- Do not force or tear anything during unpacking and setup. This may cause damage to the printer and/or its accessories.
- Do not reach inside the printer during operation.
- Always allow the printer and extruded filament to cool before reaching inside.
- Ensure that the printer is turned off and unplugged from its power source before making repairs or performing service.
- Do not install this device on an unstable surface where it could fall and cause either personal injury or damage to the device and/or other equipment.
- Do not subject the product to extreme force, shock, or fluctuations in temperature or humidity.
- This device is intended for indoor use only.
- Do not expose this device to water or moisture of any kind. Do not place drinks or other containers with moisture on or near the device. If moisture does get in or on the device, immediately unplug it from the power outlet and allow it to fully dry before reapplying power.
- Do not touch the device, the power cord, or any other connected cables with wet hands.
- Use only in a well-ventilated area. Do not use in close, confined spaces.

- Prior to operation, check the unit and power cord for physical damage. Do not use if physical damage has occurred.
- Before plugging the unit into a power outlet, ensure that the outlet provides the same type and level of power required by the device.
- Unplug this device from the power source when not in use.
- Take care to prevent damage to the power cord. Do not allow it to become crimped, pinched, walked on, or become tangled with other cords. Ensure that the power cord does not present a tripping hazard.
- Never unplug the unit by pulling on the power cord. Always grasp the connector head or adapter body.

INTRODUCTION

Thank you for purchasing this 3D printer from Monoprice! This printer features a single extruder, which is capable of printing in PLA, ABS, and other materials. You can print from a Windows® or Mac® PC using a USB connection or can print from 3D model files stored on a memory card, without the need for a PC connection of any kind. This printer is easy to setup and easy to use following the instructions in this manual.

FEATURES

- Single extrusion print head
- Can print PLA, ABS, Wood, Copper Fill, Steel Fill, Bronze Fill, and other materials
- Open frame design for ease of use and maintenance
- Includes a memory card with Cura, Repetier-Host, and a sample 3D model

CUSTOMER SERVICE

The Monoprice Customer Service department is dedicated to ensuring that your ordering, purchasing, and delivery experience is second to none. If you have any problem with your order, please give us an opportunity to make it right. You can contact a Monoprice Customer Service representative through the Live Chat link on our website www.monoprice.com or via email at support@monoprice.com. Check the website for support times and links.

PACKAGE CONTENTS

Please take an inventory of the package contents to ensure you have all the items listed below. If anything is missing or damaged, please contact Monoprice Customer Service for a replacement.

- 1x 3D printer
- 1x Filament rack
- 2x Frame brackets
- 1x Plastic scraper
- 1x USB cable
- 1x Memory card
- 4x Hex wrench (2mm, 2.5mm, 3mm, 4mm)
- 5x M5x20 screw
- 13x M4x6 screw
- 1x Open-end wrench (8mm)
- 1x AC power cord
- 1x User's manual

PRODUCT OVERVIEW

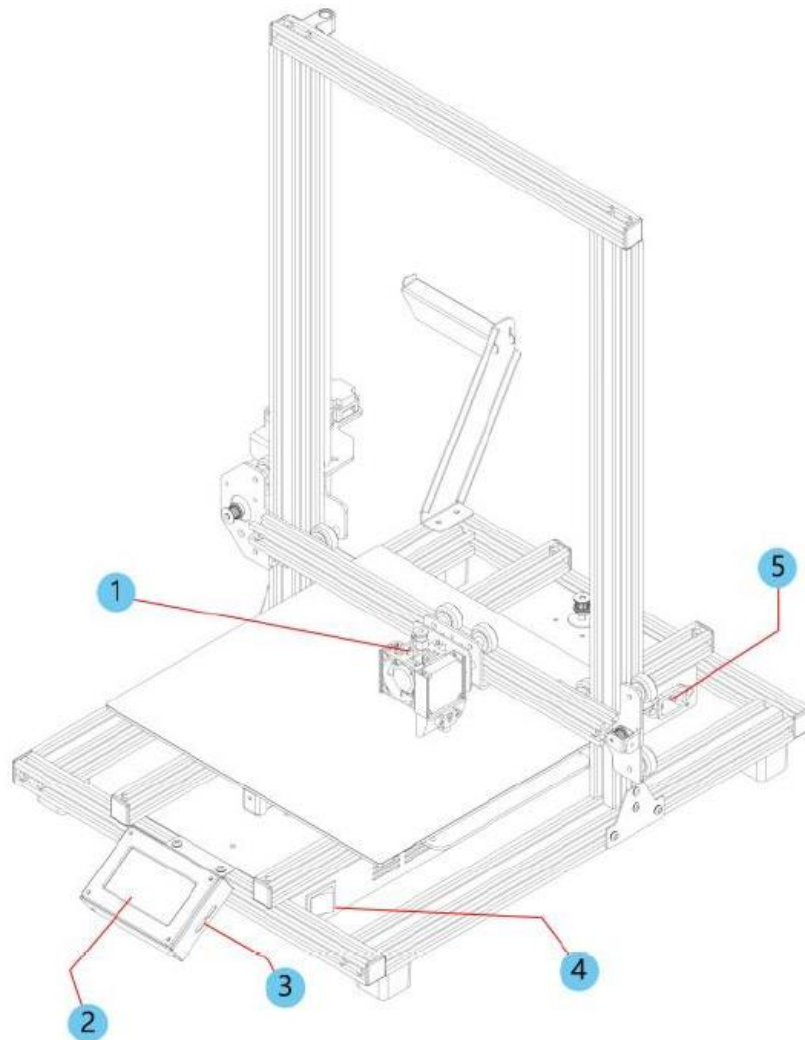

1. Extruder
2. LCD touch screen
3. Micro USB and microSD™ ports
4. Power switch
5. AC power connector

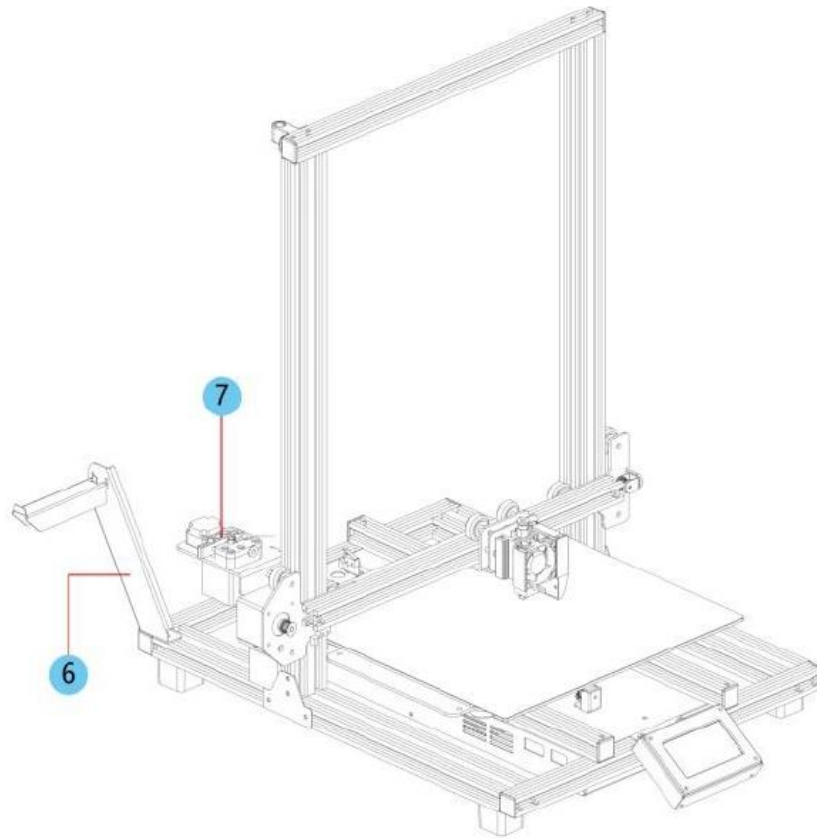

- 6. Filament holder
- 7. Feed mechanism

INSTALLATION

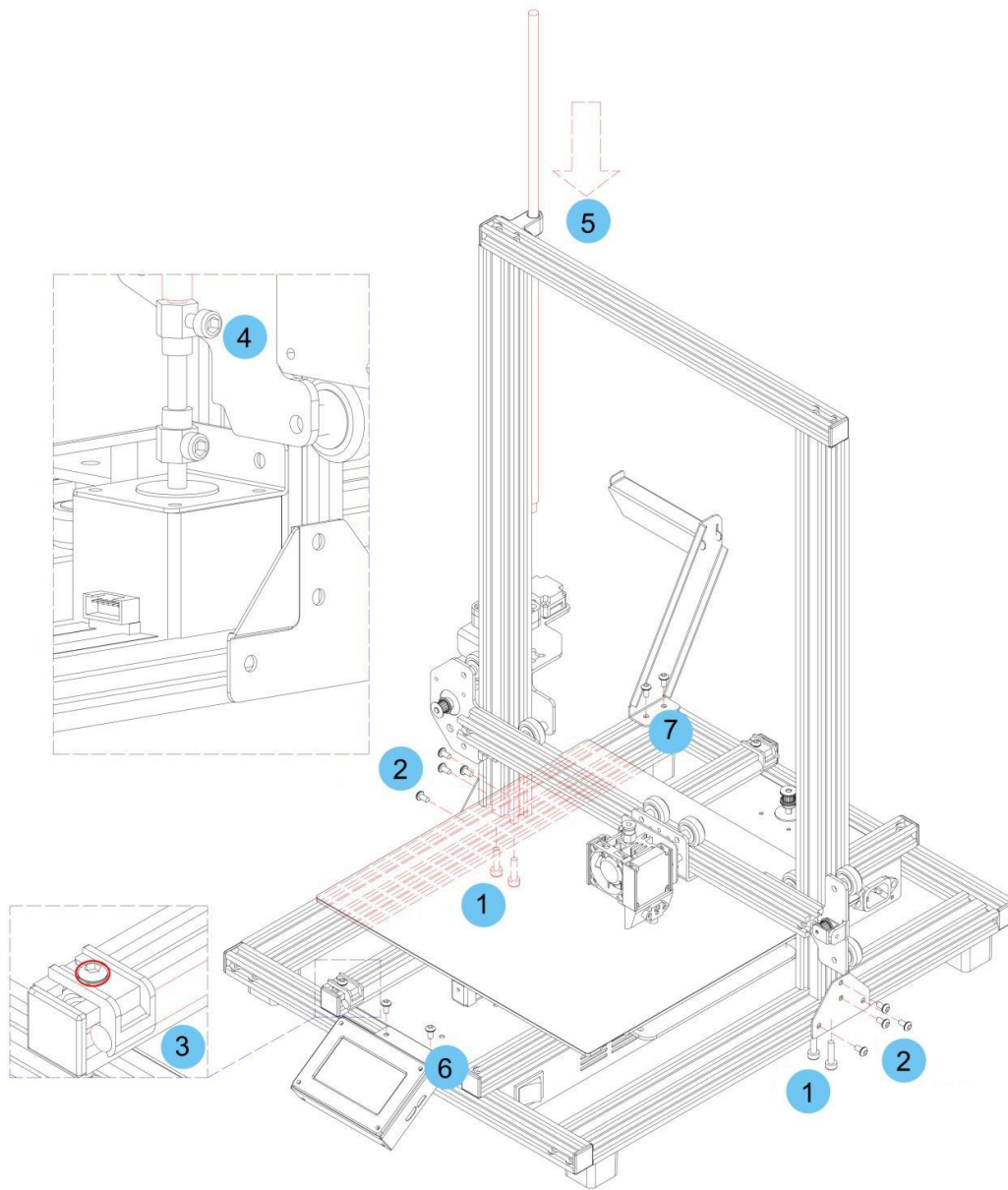

All instructions assume you are looking at the front of the printer during assembly.

1. Use the packaging material to lay the printer on its side so that you can see the holes on the bottom. Position the vertical portion of the frame opposite the holes in the bottom, align the holes on the bottom of the vertical frame with those on the horizontal frame, then use the included 2.5mm hex wrench and 4x M5x20 screws to secure the vertical frame to the horizontal frame (2 screws on each side).

2. Place the printer on its feet so that you have access to both sides. Locate the 2x **Frame Brackets**. The one with the indentation should be installed on the left side and to the rear. Align the t-nuts in the vertical and horizontal frame sections with the holes in the brackets. Using the included 4mm hex wrench and 8x M4x6 screws, attach the brackets to the junction between the vertical and horizontal frame sections.
3. The **Z Axis Lead Screw** is stored inside the **Left Y Axis Carriage Bar** and is secured in place using two plastic brackets. Use the 2.5mm hex wrench to remove the plastic brackets. You will need to move the bed backward to access the rear most bracket. Remove the **Z Axis Lead Screw** from the **Left Y Axis Carriage Bar**, then replace the plastic brackets and tighten the screws to secure them in place.
4. Using the included 3mm hex wrench, loosen the screw in the top of the motor coupling, so that the **Z Axis Lead Screw** can be inserted.
5. Insert the **Z Axis Lead Screw** through the hole in the top of the frame, then thread it through the hole on the extruder housing until the unthreaded portion of the screw is fully inserted into the motor coupling. When it is properly inserted, the top will be flush with the frame. Tighten the screw loosened in the previous step to secure the **Z Axis Lead Screw** to the motor.
6. Using the 2.5mm hex wrench and 2x M4x6 screws, fix the **LCD Display Module** to the printer frame. Insert the plug into the back of the module.
7. Align the t-nuts in the frame with the holes on the filament holder, then using the 2.5mm hex wrench and 2x M4x6 screws, secure the filament holder to the frame.
8. Mount the extruder hotend to the bracket on the **X Axis Gantry** by aligning the positioning rods and magnets. Ensure that the cables are on top.
9. Plug the three cable connectors into the appropriate connections on the front left side of the **Left Y Axis Carriage**, beneath the **Z Axis Lead Screw** storage location referenced in step 3 above.

SETUP

Warning! Take care not to remove or damage the printing surface on the build platform. This paper is essential to ensure the 3D model properly adheres to the build platform during printing. If this tape becomes damaged or wears out, replace it with painter's tape, Kapton® tape, or ordinary masking tape.

Perform the following steps to prepare the printer for use.

1. Put the printer on a flat, stable surface with plenty of ventilation and a nearby AC power outlet.
2. Ensure that the **Power Switch** is in the **OFF** position. Plug the included **AC Power Cord** into the **AC Power Connector** jack on the right side of the printer, then plug the other end into a nearby AC power outlet. Flip the **Power Switch** to the **ON** position.
3. Insert the included memory card into the slot on the right side of the LCD module.
4. Touch the **Preheat** button on the **Main Menu**.

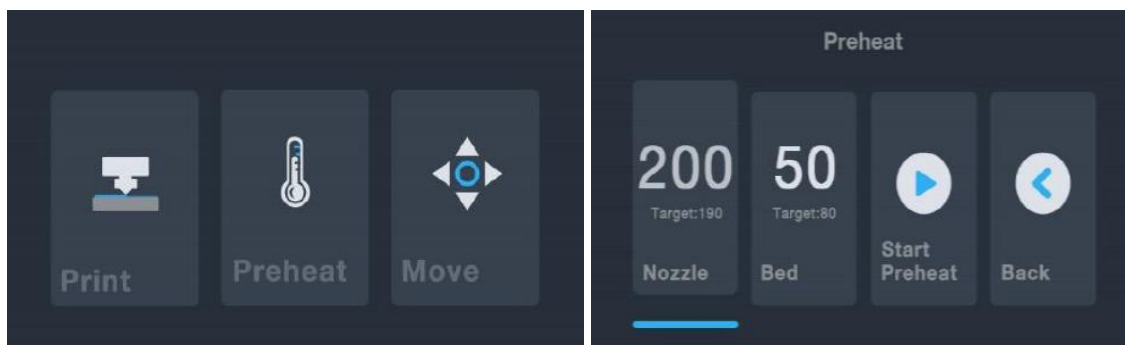

5. Touch the **Nozzle** button, then set the temperature of the nozzle to your target value. The target value depends on the type of filament being used. For the included sample PLA filament, the temperature should be between 200~220°C.
6. Touch the **Bed** button, then the temperature to the target temperature for your filament type.
7. Touch the **Start Preheat** button. The printer will start preheating the nozzle and heated print bed to your target value(s) and the **Start Preheat** button will change to **Stop Preheat**. The **Nozzle** and **Bed** buttons will display the temperatures as they change.

8. While the printer is heating, open your filament. Using a pair of scissors or side cutters, diagonally snip the end of the filament to make a point, as shown in the images below. Place the filament reel on the filament rack.

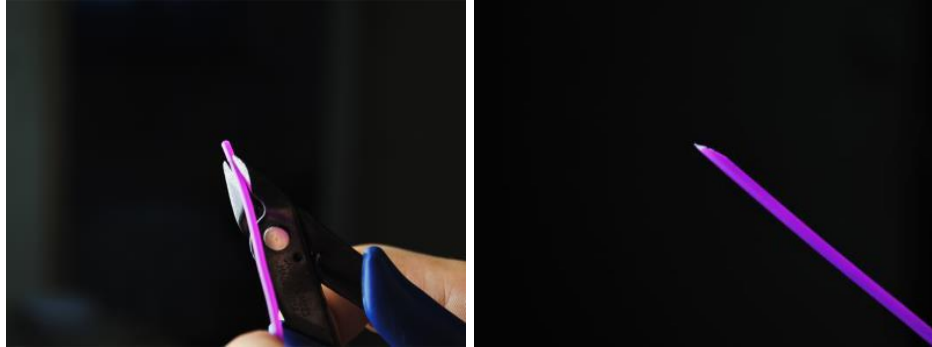

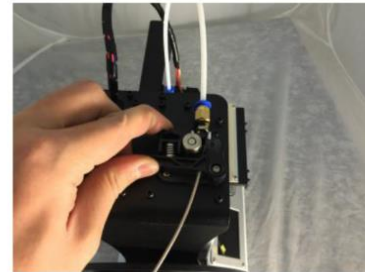

9. Touch the **Back** button on the **Preheat Menu** to return to the **Main Menu**, then touch the **Move** button on the **Main Menu** to enter the **Move Menu**. Touch the  button in the **Z** column to raise the extruder about 3~5 cm above the build platform.

10. While squeezing the lever on the **Feed Mechanism**, insert the filament and push it into opening. Keep pushing until you feel resistance as it hits the hotend. This should be about 30cm of filament. Release the lever on the **Feed Mechanism**.

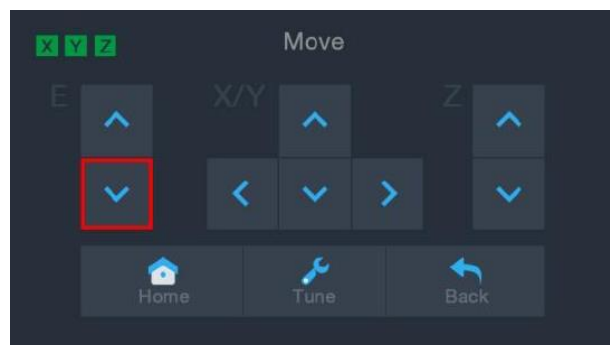

11. Touch the  button in the **E** column on the **Move Menu** to feed filament into the extruder/hotend. Continue touching the button until several centimeters of filament have been extruded.



12. Using the included plastic scraper, clean the extruded filament from the nozzle and build platform. *It is normal for filament to ooze from the nozzle while the printer is hot.*
13. Touch the  button on the **Move Menu** to return to the **Main Menu**.
14. Touch the **Print** button on the **Main Menu**. The printer will read the contents of the memory card and display them on screen. Touch the **cat.gcode** file to start printing the model. The sample print can take up to 3 hours to print.

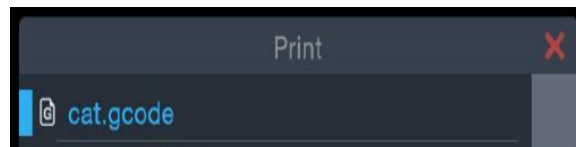

15. After the first layer has been printed, touch the **Pause** or **Cancel** button to stop printing.

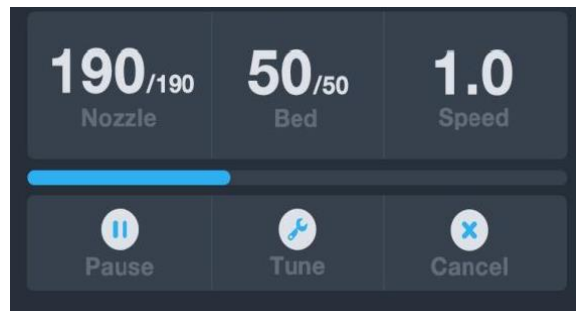

16. Compare the first layer with the images in the table below to determine whether the build platform needs to be leveled or not. If it does need adjustment, touch the **Cancel** button on the **Print Menu** to stop the print. The **Main Menu** will appear.

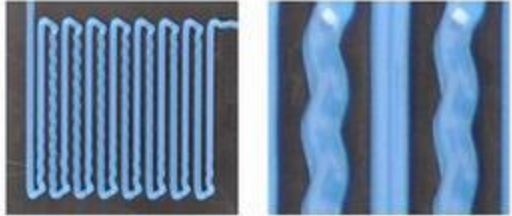
Wrong		The nozzle is too far from the platform. This can result in the extruded material not sticking to the build platform.
-------	---	---

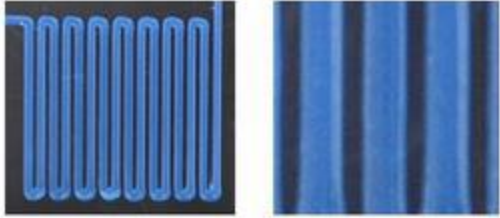
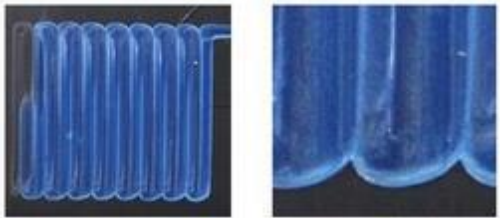
Correct		The nozzle is at the correct height above the platform.
Wrong		The nozzle is too close to the platform. This can result in damage to the nozzle and build platform.

ASSISTED LEVELING

If the gap between the nozzle and the build platform is not correct, use the **Auto Level** function to adjust the gap. You will want to perform Auto Leveling before using the printer for the first time or after it is moved.

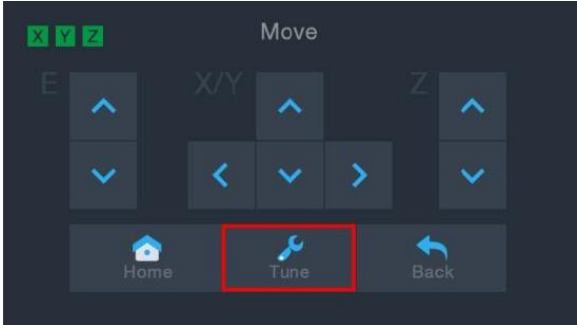

Note that the **Auto Level** function will determine the local offsets for each location on a 5"x5" grid. It will not set the global Z offset for the bed distance. This is set by tuning the offset during the print or in the menu starting the auto level function. See the *GLOBAL Z OFFSET LIVE LEVEL* section below for details.

1. With the printer powered on and the **Main Menu** displayed, touch the **Move** button on the **Main Menu**, then touch the **Tune** button on the **Move Menu** to enter the **Set Offset Menu**.

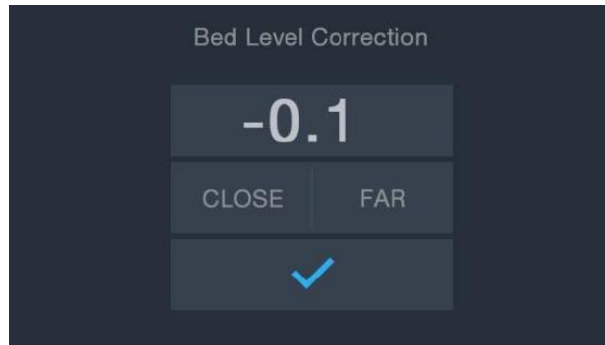

2. Touch the **Auto Leveling** button. The printer will move the extruder to different points and measure the distance from the nozzle to the print bed to determine the proper local offset at each point. This function only works with the metal print bed, which is standard on the MP10 printer.



3. Touch the **Move** button on the **Main Menu** to enter the **Move Menu**, then touch the  button in the **Z** column to raise the extruder about 1-2 inches above the build platform.
4. Using the plastic scraper, clean the extruded filament from the bed and hotend.
5. Touch the **Tune** button on the **Move Menu** to enter the **Set Offset Menu**. If the nozzle was too close, touch the **FAR** button. If the nozzle was too far, touch the **CLOSE** button. This adjusts the Z Offset by 0.1mm. Once the gap is where you want it, touch the  button to save the data and exit the menu.
6. Restart the print by following steps 14-16 in the SETUP section above.

GLOBAL Z OFFSET LIVE LEVEL

While printing the model, you can use this function to fine tune the gap between the nozzle and the bed. Touch the Tune button to enter the **Bed Level Correction** menu, then touch the **FAR** or **CLOSE** to increase or decrease the gap between nozzle and the bed. This can assist in getting a good first layer, but be careful to allow the printer a short period of time to implement the change.

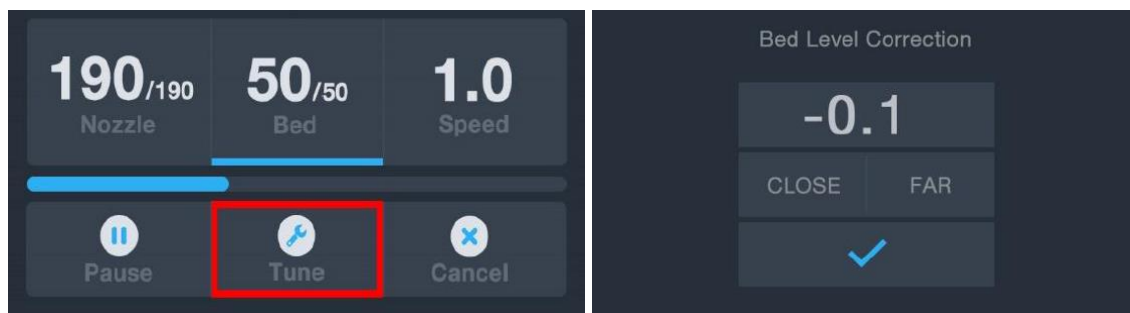

OPTIONAL WI-FI SETUP

You can connect the printer wirelessly to a 2.4GHz Wi-Fi® network to print models from your Android™ phone or tablet. Perform the following steps to setup the Wi-Fi connection for your device.

1. Open Notepad on your PC to create a new file.
2. Copy the below block of gcode into the empty text file.
3. Replace the **SSID** in the gcode with your network SSID and the **PASSWORD** in the gcode with your network's password. Your password cannot contain any semicolons.
4. Save the file using the filename **WiFi.gcode** onto a microSD™ card.
5. Insert the microSD card into the card slot on the printer.
6. Select **Print** from the printer's **Main Menu**. The printer will read the contents of the microSD card.

7. Locate and select the **WiFi.gcode** file. Once the printer centers the print head, the process has been completed and your printer should be connected to your Wi-Fi® network.

Notes:

1. *You may have difficulty connecting to the Wi-Fi® network if you have a 2.4GHz and 5GHz network with the same SSID. Try changing the SSID of the 5GHz network if this occurs. For best results, move the printer to a location closer to the Wi-Fi router or access point.*
2. *The printer cannot use both a Wi-Fi and USB connection.*

Gcode Block

```
M106 S0 ; turn fan off in case it was already on
M106 S200 ; turn fan on to signify start
G28 X Y ; home X & Y to signify start
;
;
M550 SSID
M551 PASSWORD
;
;
G1 X150 Y150 F1000 ; CENTER bed to signify completion
M106 S0 ; turn fan off to signify completion
M84 ; disable motors
```

Note that in the above gcode block, there are four lines that start with a semicolon. The 1st, 3rd, and 4th lines have a single space after the semicolon and the 2nd line has two spaces after the semicolon. These spaces must be present, so do not use a text editor that strips trailing spaces.

SOFTWARE INSTALLATION AND SETUP

As you've seen, you can print a model directly from a gcode file on a microSD™ card and this is the preferred method, as it does not require a continuous connection to your computer. You can download gcode files to the microSD card and print them without having to build any model files.

However, you can create your own gcode files using an open source program, such as Cura or Repetier-Host, which are pre-installed on the microSD card that comes with the printer. These programs use 3D models (typically .STL or .OBJ files) and, using machine specific information, generate a gcode file with detailed instructions for the printer to create the selected model. We recommend you start with Cura, since it includes a Slicing Engine.

Installing Cura

1. Use a card reader to read the contents on the included microSD™ card. Locate and double-click the **Cura_3.3.1.exe** file to start the setup program.
2. Click the **Next** button on the **Welcome** screen, then click the **I Agree** button on the **License Agreement** screen.

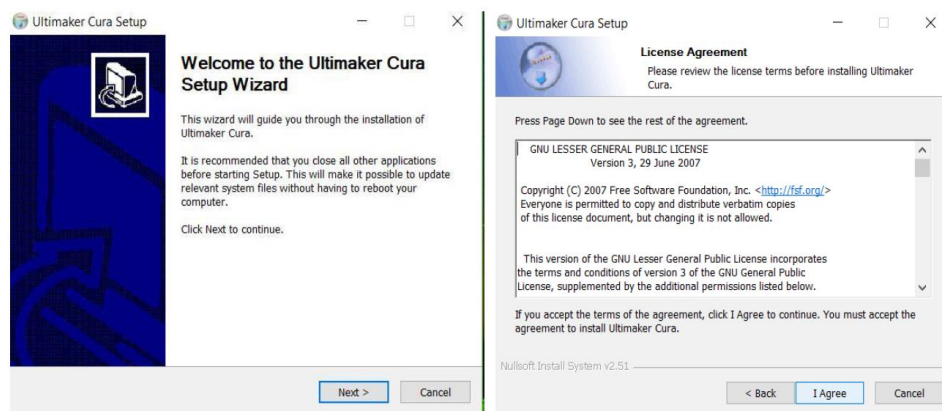

- Use the file browser to select an install directory or accept the default directory (recommended). Click the **Next** button to continue.

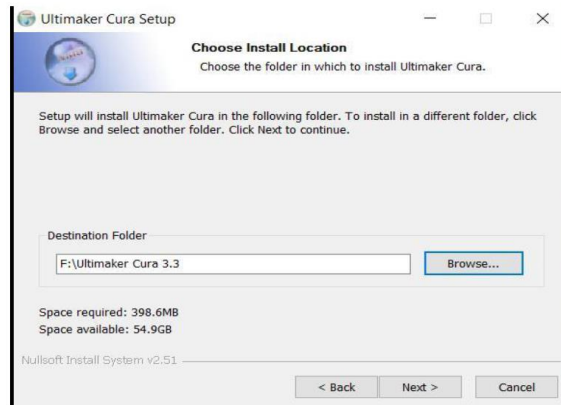

- Ensure that all boxes are checked, then click **Install** to continue.

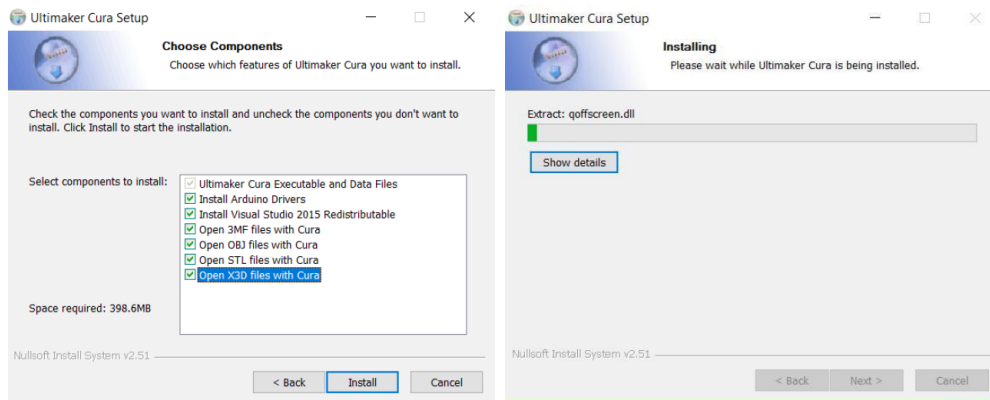

- Click **Finish** to complete the installation and launch the Cura program.

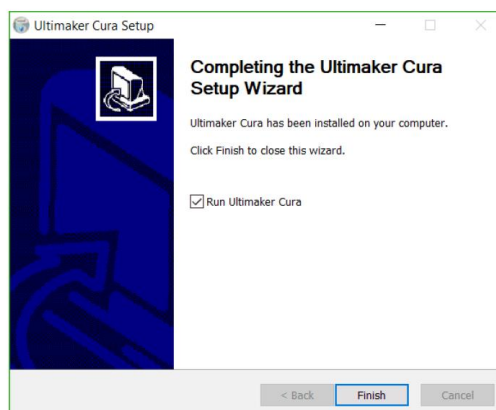

6. Click **Printer > Printer > Add Printer...**

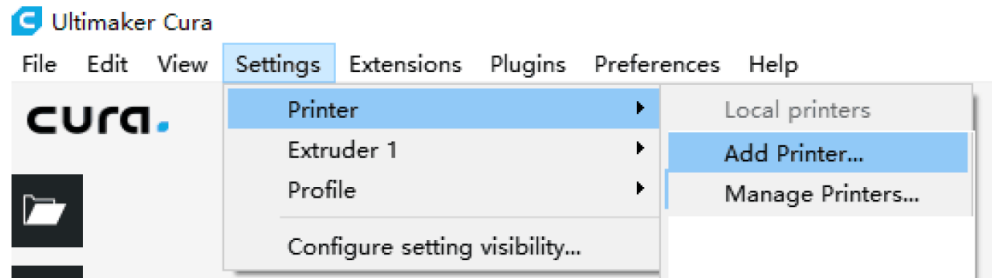

7. Click the **Other** option, then choose the **Monoprice MP10** entry. Click the **Add Printer** button to continue.

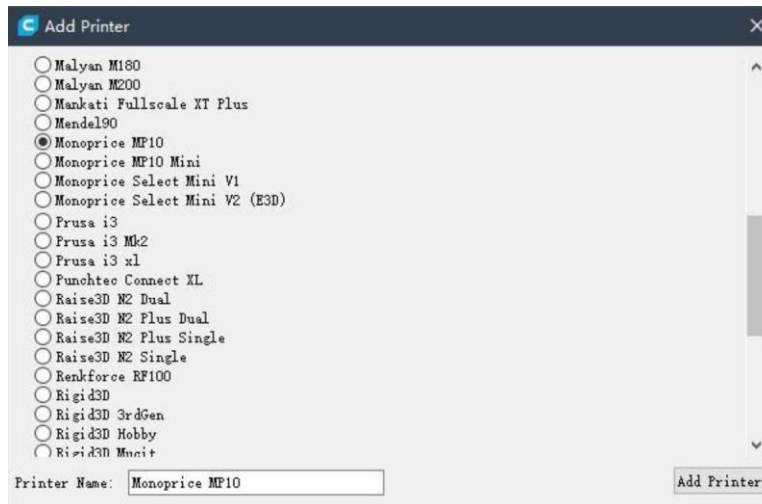

- The **Machine Settings** screen will be displayed. Click the **Close** button to finish the Cura installation.

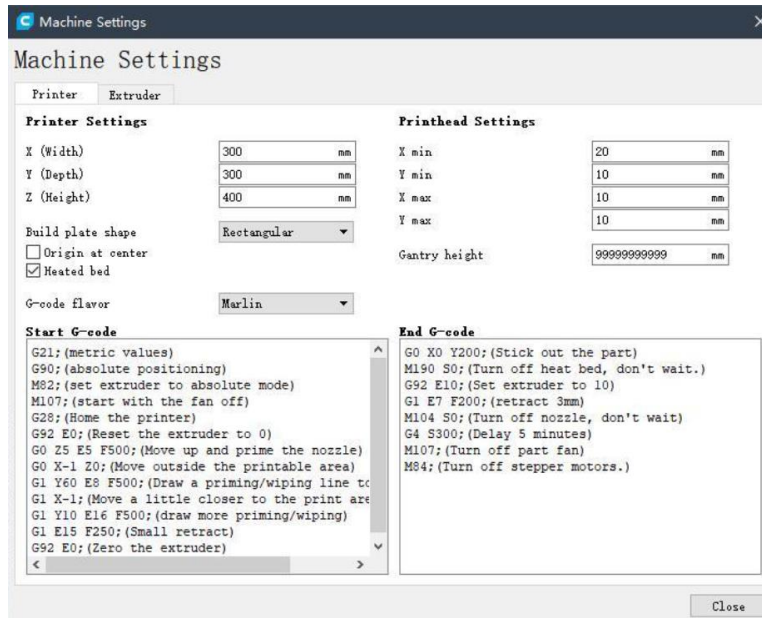

Repetier-Host

You can also install Repetier-Host from the file on the included microSD™ card. The screenshots below show the proper Repetier-Host settings to use for this printer.

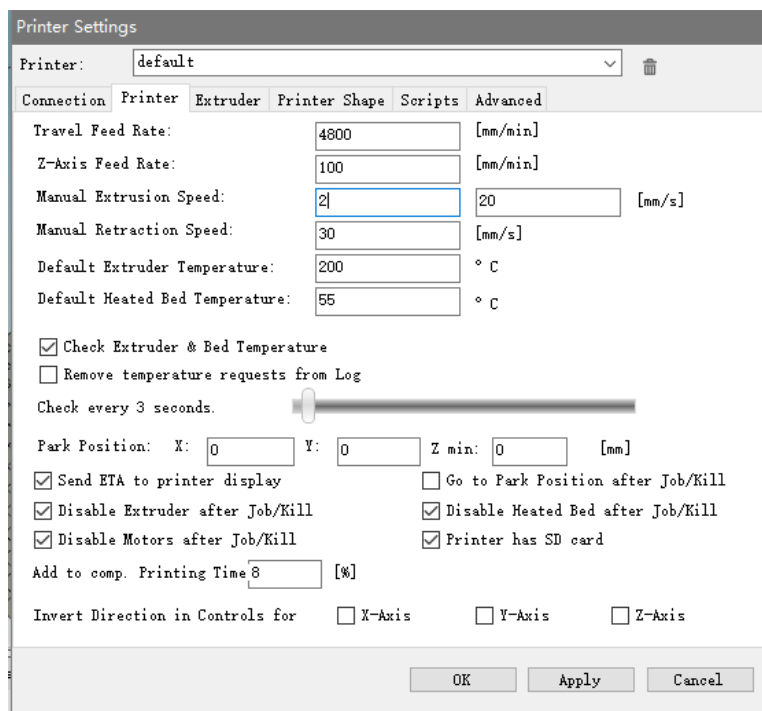

Printer Settings

Printer: **default** 

Connection | Printer | **Extruder** | Printer Shape | Scripts | Advanced

Number of Extruder:

Number of Fans:

Max. Extruder Temperature:

Max. Bed Temperature:

Max. Volume per second: [mm³/s]

Printer has a Mixing Extruder (one nozzle for all colors)

Extruder 1

Name:

Diameter: [mm] Temperature Offset: [° C]

Color:

Offset X: Offset Y: [mm]

OK Apply Cancel

Printer Settings

Printer: **default** 

Connection | Printer | Extruder | **Printer Shape** | Scripts | Advanced

Printer Type: **Classic Printer**

Home X: **Min** Home Y: **Min** Home Z: **Min**

X Min: X Max: Bed Left:

Y Min: Y Max: Bed Front:

Print Area Width: mm

Print Area Depth: mm

Print Area Height: mm

The min and max values define the possible range of extruder coordinates. These coordinates can be negative and outside the print bed. Bed left/front define the coordinates where the printbed itself starts. By changing the min/max values you can even move the origin in the center of the print bed, if supported by firmware.

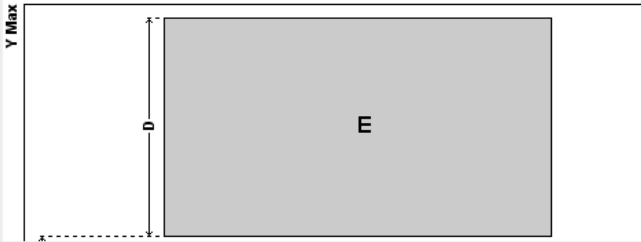

OK Apply Cancel

TECHNICAL SUPPORT

Monoprice is pleased to provide free, live, online technical support to assist you with any questions you may have about installation, setup, troubleshooting, or product recommendations. If you ever need assistance with your new product, please come online to talk to one of our friendly and knowledgeable Tech Support Associates. Technical support is available through the online chat button on our website www.monoprice.com or through email by sending a message to tech@monoprice.com. Check the website for support times and links.

REGULATORY COMPLIANCE

Notice for FCC



This device complies with Part 15 of the FCC rules. Operation is subject to the following two conditions: (1) this device may not cause harmful interference, and (2) this device must accept any interference received, including interference that may cause undesired operation.

Modifying the equipment without Monoprice's authorization may result in the equipment no longer complying with FCC requirements for Class B digital devices. In that event, your right to use the equipment may be limited by FCC regulations, and you may be required to correct any interference to radio or television communications at your own expense.

This equipment has been tested and found to comply with the limits for a Class B digital device, pursuant to Part 15 of the FCC Rules. These limits are designed to provide reasonable protection against harmful interference in a residential installation. This equipment generates, uses and can radiate radio frequency energy and, if not installed and used in accordance with the instructions, may cause harmful interference to radio communications. However, there is no guarantee that interference will not occur in a particular installation. If this equipment does cause harmful interference to radio or television reception, which can be determined by turning the equipment off and on, the

user is encouraged to try to correct the interference by one or more of the following measures:

- Reorient or relocate the receiving antenna.
- Increase the separation between the equipment and receiver.
- Connect the equipment into an outlet on a circuit different from that to which the receiver is connected.
- Consult the dealer or an experienced radio/TV technician for help.

Modifying the equipment without Monoprice's authorization may result in the equipment no longer complying with FCC requirements for Class A digital devices. In that event, your right to use the equipment may be limited by FCC regulations, and you may be required to correct any interference to radio or television communications at your own expense.



EU Declaration of Conformity

Monoprice, Inc. declares the product described within this user guide or manual is in compliance with below applicable directives. The full text of the EU Declaration of Conformity is available at the following internet address:

https://www.monoprice.com/product?c_id=107&cp_id=10724&cs_id=1072403&p_id=34437&seq=1&format=2 or the CE DoC can be found within this user manual.

- EMC Directive 2004/108/EC
- Low Voltage Directive 2014/35/EU
- RoHS2 Directive 2011/65/EU
- WEEE Directive 2012/19/EC
- Packaging & Packaging Waste Directive 94/62/EC
- REACH Directive 1907/2006/EC

WEEE Information

User information for consumer products covered by EU Directive 2012/19/EU on Waste Electric and Electronic Equipment (WEEE).

This document contains important information for users with regards to the proper disposal and recycling of Monoprice products. Consumers are required to comply with this notice for all electronic products bearing the following symbol:



For Consumers in the European Union: This EU Directive requires that the product bearing this symbol and or its packaging must not be disposed of with unsorted municipal waste. The symbol indicates that this product should be disposed of separately from regular household waste streams. It is your responsibility to dispose of this and other electrical and electronics products via designated collection facilities appointed by the government or local authorities. Correct disposal and recycling will help prevent potential negative consequences to the environment and human health. For more detailed information about the disposal of your unwanted product, please contact your local authorities or waste disposal service.

Safety Notice



WARNING: Do not use this product near water, for example, in a wet basement or near swimming pool or in an area where accidental contact with water or liquid might occur.

WARNING: Avoid using this product during an electrical storm. There may be a remote risk of electric shock from the surge caused by lightning.

WARNING: The external power adapter or AC power cord is the equipment's disconnection device. The power outlet must be located nearby the equipment and its access must be easy.

WARNING: Use this product in a well-ventilated area.

Microsoft® and Windows® are registered trademarks of Microsoft Corporation in the United States and/or other countries.

SD® and microSD® are trademarks or registered trademarks of SD-3C, LLC in the United States, other countries, or both.

DuPont™ and Kapton® are trademarks or registered trademarks of E.I. du Pont de Nemours and Company.

Wi-Fi® is a registered trademark of Wi-Fi Alliance.

Android™ is a trademark of Google LLC.