

# CHASING *DORY*

Everyday Underwater Exploration

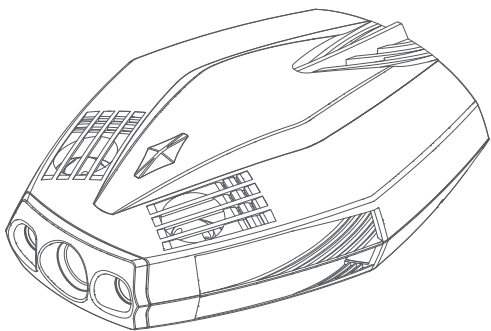

## User Manual

# Disclaimer

Thank you for purchasing the CHASING DORY underwater drone. Please read this entire document carefully before using the drone. By using this product, you hereby signify that you have read this disclaimer and all instructions carefully and that you understand and agree to abide by the terms and conditions herein.

---

CHASING DORY is a small five thruster underwater drone used for real-time observation, exploration, photography, and video capture. Chasing accepts no liability for damage, injury, or any legal responsibility incurred directly or indirectly from the use of CHASING DORY in the following conditions:

01. Damage(s) or injuries incurred when users are drunk, taking drugs, drug anesthesia, dizziness, fatigue, nausea and any other conditions no matter physically or mentally that could impair your ability.
02. Damage(s) or injuries caused by subjective intentional operations.
03. Any mental overcompensation caused by accident.
04. Failure to follow the guidance of the manual to assemble or operate.
05. Malfunctions caused by refit or replacement with non-Chasing accessories and parts, or unauthorized modification, disassembly, or shell opening not in accordance with official instructions.
06. Damage(s) or injuries caused by using third-party products or fake Chasing products.
07. Damage(s) or injuries caused by misoperation or subjective misjudgment.
08. Damage(s) or injuries caused by mechanical failures due to erosion, aging.
09. Damage(s) or injuries caused by operating the unit with a low battery alert.
10. Damage(s) or injuries caused by operating the drone out of maximum safe range and depth.
11. Damage(s) or injuries caused by knowingly operating the product in abnormal conditions (such as the assembly is not completed, or the main components have obvious faults, obvious defect or missing accessories).
12. Damage(s) or injuries caused by operating the drone in a sensitive zone such as a military area or private waters without official permission.
13. Damage or injury caused by using in bad water conditions (such as high winds, or turbid zone).
14. Damage or injury caused by uncontrollable external factors, including severe collision, tidal wave, swallowed by animal.
15. Damage(s) or injuries caused by infringement such as any data, photo or video material recorded by the use of the CHASING DORY.
16. Other losses that are not covered by the scope of Chasing's liability.

# Drone

CHASING DORY is a small five thruster underwater drone used for real-time observation, exploration, photography, and video capture. The drone can move up and down vertically and can tilt  $\pm 45^\circ$ . It can dive up to 50 meters (49ft) and has a high-definition camera for shooting photos and videos. The drone is easy to operate and its small size allows it to be carried in a single backpack. It has a battery life of approximately 1 hour. Whether you're diving, fishing, taking underwater photography, or yachting, the CHASING DORY is your best choice.

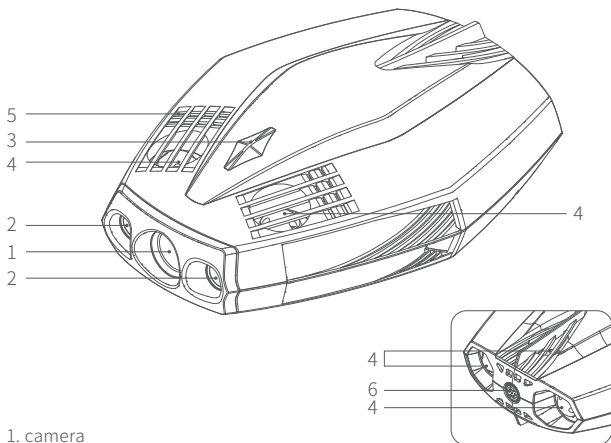

# Wi-Fi Buoy

The function of the buoy is to provide Wi-Fi signal, so that the mobile phone can connect with the drone through Wi-Fi, making it possible to control the drone in real time. The buoy also has a TF card and a GPS chip.

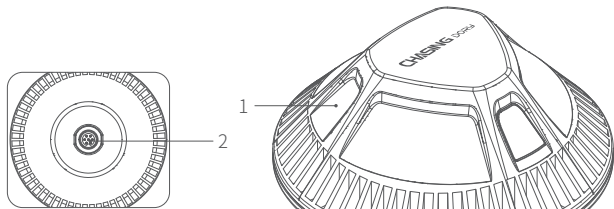

1. flash light
2. tether socket

# Tether

The tether is used to connect the drone and buoy.

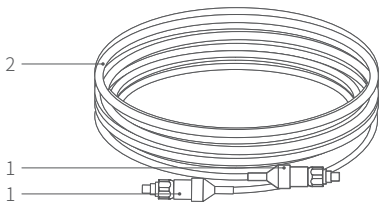

1. tether connectors
2. tether

# Installation & Connection

## 1 Download CHASING DORY APP

Scan QR code or visit iOS app store /  
Google Play to download.  
(iOS 9.0 / Android 5.0 and above)



---

## 2 Connect Drone and Wi-Fi Buoy

Insert one end of the tether into the drone and the other end into the Wi-Fi buoy. Securely hand-tighten both coupling bolts.

**⚠ Note:** Check the O-rings on the tether connectors. If they are missing or damaged, please replace them. Make sure the tether connectors are dry before connecting.

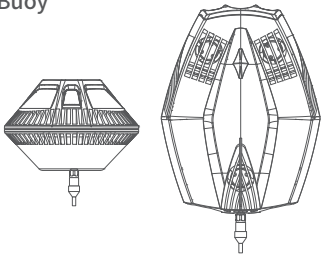

---

## 3 Booting Up

Once the Dory and the Wi-Fi buoy are connected, the LED lights on the drone will flash and you will hear two self-test sounds. A flashing green light will indicate that both the Dory and Wi-Fi buoy are powered on.

## 4 Wi-Fi Connection

On your mobile device, go to Wi-Fi settings.

Click “Dory\_XXXX” network and enter password 12345678.



## 5 CHASING DORY APP Tutorial

Open the app, when you see "connected" on the bottom left corner, click "start" on the right. Now you will see the main APP interface (below). Click the power button to unlock the drone and use the virtual joy stick on screen to control the drone's movement.

**▲ Note:** Do not start the Dory motors while out of the water. Doing this can seize the motors.

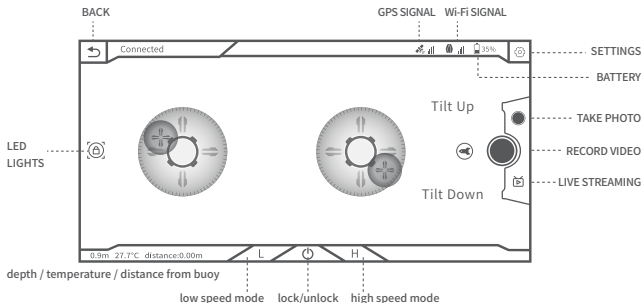

**▲ Note:** For better user experience, we are constantly updating software interface & features.

## ↓ Photo & Video Download

- 1 Once the drone and buoy are connected, open CHASING DORY app and click on "Media"

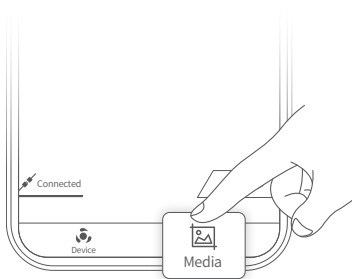



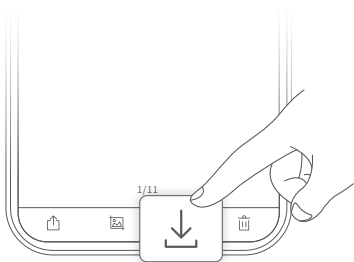









- 2 Find the video / photo you wish to download.  
Click the download button to save it directly to your phone / tablet.



# Navigation

The CHASING DORY has 8 states: ascending, decending, left turn, right turn, forward, backward, lowering the head, and lifting the head. See details below on how to use the virtual controller to navigate.

Flight Direction	American Hand	Japanese Hand	Virtual Controller
Ascending / Decending 	left virtual joystick, move up and down 	right virtual joystick, move up and down 	options to customize
Turn left / right 	left virtual joystick, move left and right 	left virtual joystick, move left and right 	options to customize
Forward / Backward 	right virtual joystick, move up and down 	left virtual joystick, move up and down 	options to customize
Lowering the head / Lifting the head 	Tilt up / Tilt down 	Tilt up / Tilt down 	

**▲** Note: The default mode is Japanese hand. You can switch to American hand or customize settings in the app.





## Charging Guidelines

### Power adapter indicator light:

A solid red light indicates normal charging is in process. A solid green light indicates a complete charge. After charging, please unplug the power adapter.

**▲ Note:** Wi-Fi buoy does not have a battery and requires no charging. Please DO NOT charge the Wi-Fi buoy.

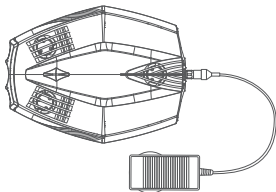

## Specifications

### DRONE

SIZE	247*188*92mm
WEIGHT	1.1kg
MAX DEPTH	15m
MAX SPEED	1.5kn
RUNTIME	60min
BATTERY CYCLE LIFE	≥300times

### BUOY

SIZE	130*130*88mm
WEIGHT	160g
STORAGE	16G
MAX WiFi DISTANCE	15m

### CAMERA

CMOS	1/2.9-inch
LENS	f/1.6
FOCUS	4mm
ISO RANGE	100-3200
FOV	100°
MAX RESOLUTION	2M (1920*1080)
FORMAT	JPEG
VIDEO	FHD: 1920*1080 30FPS
VIDEO STREAM	4M
VIDEO FORMAT	MP4

### CHARGER

POWER	12.6V 1.8A
CHARGING TIME	3 hours

## LED

BRIGHTNESS	2*250 Lumens
COLOR TEMPERATURE	4500K-5000K
CRI	80

## SENSOR

	3 axis gyro/ accelerometer/ compass
IMU	
DEPTH SENSOR	$\leq \pm 0.5\text{m}$
TEMPERATURE SENSOR	$\leq \pm 2^{\circ}\text{C}$

# Precautions

## ① Navigation Safety



Open sea navigation



Suggested to use in calm waters



For best results dive in clear waters, avoid heavy seaweed areas.



No dense radio or radar signals



Do not dive more than 15m



The buoy's Wi-Fi range is 15 meters. If distance between Wi-Fi buoy and phone exceeds this distance, the connection will be lost.

## ② Battery Protection

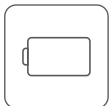

Do not run out of battery power



Charge it when the power is less than 25%



When not in use, keep battery power at 50% - 70%

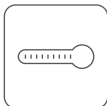

Working temperature  
 $-10^{\circ}\text{C} \sim 60^{\circ}\text{C}$   
( $14^{\circ}\text{F} \sim 140^{\circ}\text{F}$ )

**▲ Note:** Fully discharge every 3 months.

### 3 Others



When not in use, do not expose the drone to sunlight. Store it in a cool dry place or in the protective case



Children must use product under adult supervision



Before use, check for water on the tether connectors. If present, wipe with a towel.



After each use please wash the motor and propellers with clean water.

## Others

1. Do not turn on the LED lights before entering the water.
2. Rusted screws should be replaced immediately.
3. After each use, dry the connectors on drone, buoy and tether with absorbent towel.
4. Do not place heavy objects on drone or tether to avoid possible damage.
5. When not in use, do not expose the drone to sunlight. Store it in a cool place or in the protective case.
6. Do not run drone motors out of water for more than two minutes to avoid wearing out thrusters.

## Support

If you have any questions, please contact [support@chasing-innovation.com](mailto:support@chasing-innovation.com). You can also join the Official Chasing Dory Owners Group on Facebook for official news and app update notifications.

