

LIAN LI

Feel the difference

O11 DYNAMIC XL

Installation Guide / 安裝說明書
Guide d'installation / Montageanleitung
Guía de instalación / インストレーションガイド

* Case components

* Composants du boîtier

* Guía de instalación

* 機殻部品紹介

* Gehäusekomponenten

* ケース各部紹介

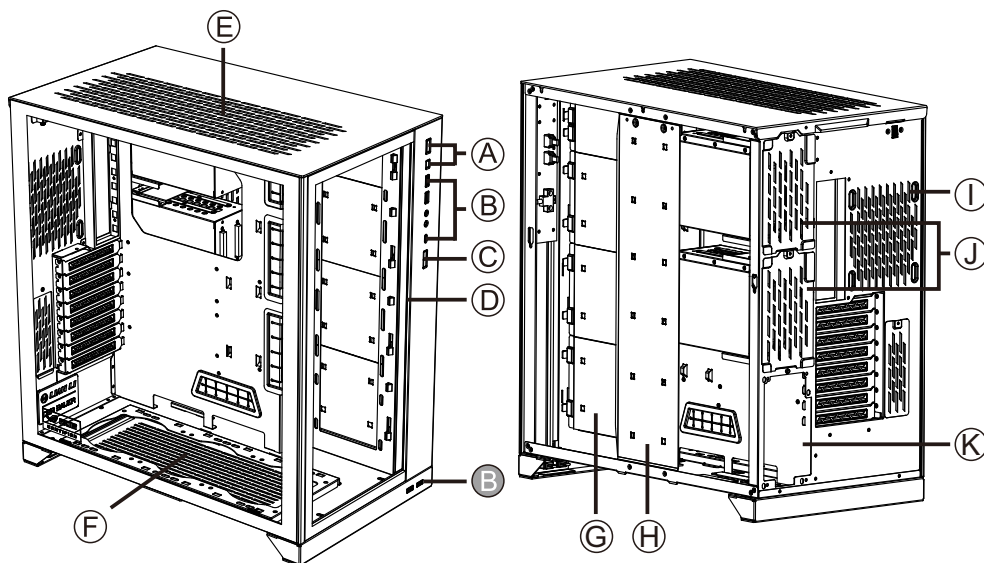

(A) Power switch / reset button

(B) IO ports: USB 3.0 x 2, HD audio & mic, USB 3.1 x 1(Type-c)

(E) USB 3.0 x 2

(C) ARGB control button (M: Mode, C: Color)

(D) ARGB LED strip

(E) Supporting 120 mm fan x 3 or 140 mm fan x 2 or 360 mm radiator x 1

(F) Removable fan/SSD tray: Supporting 120 mm fan x 3 or 140 mm fan x 2 or 360 mm radiator x 1 or 2.5" SSD x 3

(G) Additional SSD trays x 3: Supporting 120 mm fan x 3 or 360 mm radiator x 1 or 2.5" SSD x 3

(H) Removable SSD tray: Supporting 2.5" SSD x 3

(I) Supporting 120mm fan x 1

(J) Hot swappable drive trays: Supporting 3.5" HDD x 4 or 2.5" SSD x 4 or ATX PSU x 2

(K) PSU tray: Supporting ATX PSU x 1

* Hardware list
* 零件盒部品一覧表

* Liste des pièces
* Hardwareliste

* Lista de materiales
* 付属品一覧



Screws for motherboard & 2.5" SSD mount

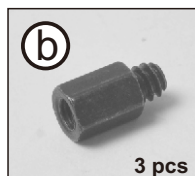

Stand-off bolt (Spare parts) for motherboard mount



Screws for PSU mounting

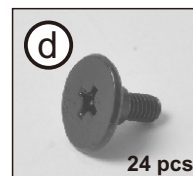

Screws for 2.5" SSD mount



Screws for 3.5" HDD mount

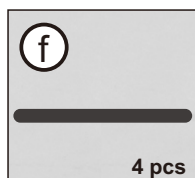

Velcro for cable management

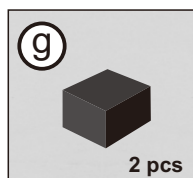

Rubber pad for PSU mounting

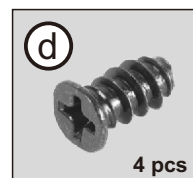

Screws for fan mounting

<p>1 PIECE</p>	<p>2 pcs</p>	<p>2 pcs</p>	<p>2 pcs</p>
	<p>2 pcs</p>	<p>Tool 2 pcs</p>	<p>4 pcs</p>

For Graphics Card Anti-Sag Bracket (GB-001) installation

- ※ Exceeded quantity are spare parts.
- ※ 多餘的零件數量是備品。
- ※ Les pièces supplémentaires sont des pièces de rechange.
- ※ Zusätzliche Teile können als Ersatzteile verwendet werden.
- ※ Exceeded quantity are spare parts.
- ※ ネジには予備が含まれてています。

- * Remove top panel
- * 卸下頂部面板
- * Retirer le panneau supérieur
- * Entfernen Sie die obere Abdeckung
- * Retire el panel superior
- * トップパネルを取り外す

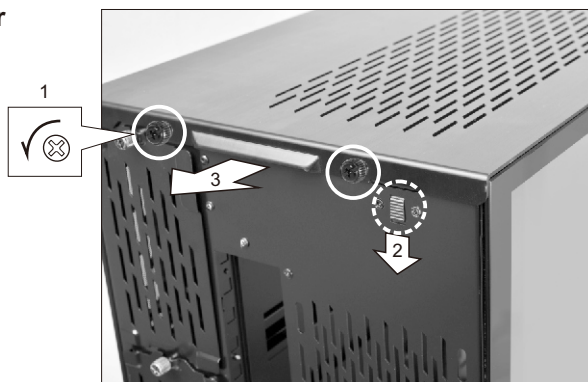

- * Remove side glass & front glass
- * 卸下側面玻璃及前面玻璃
- * Enlever le verre latéral et frontal
- * Entfernen Sie die Seiten- und Frontscheibe
- * Retire el vidrio lateral y frontal
- * サイド&フロントガラスを取り外す

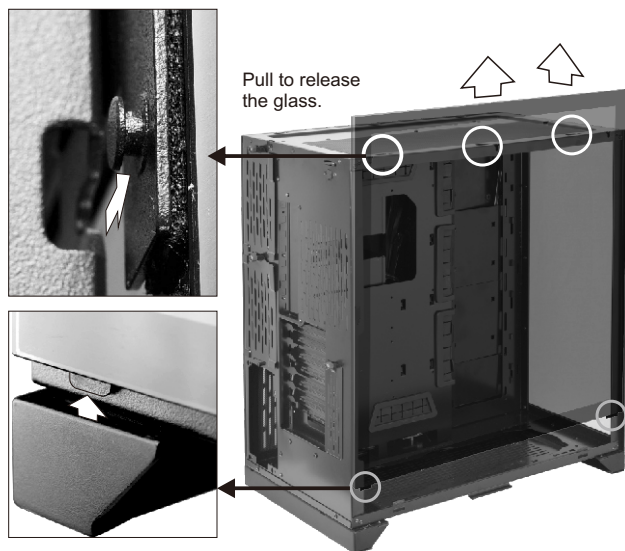

Attention:
Peel off the protective film on both sides

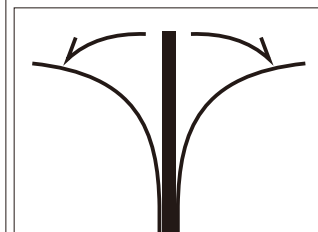
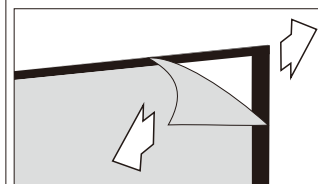

- * PSU installation
- * 電源供應器安裝
- * Installation du plateau du bloc d'alimentation

- * PSU-Einsatz installieren
- * Instalación de la fuente de alimentación
- * 電源ユニットの取り付け

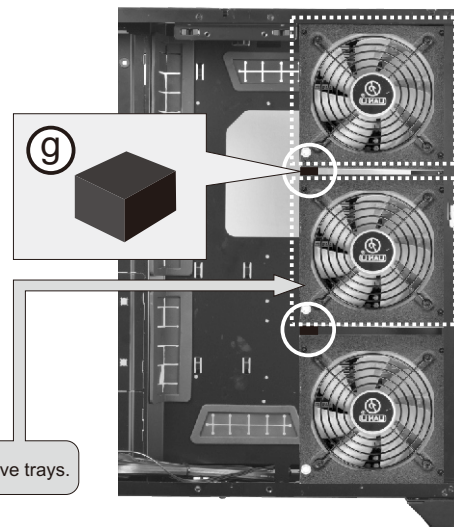
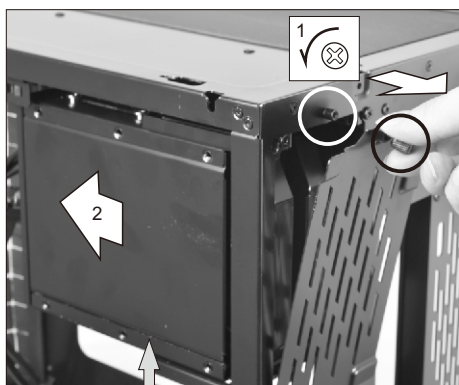
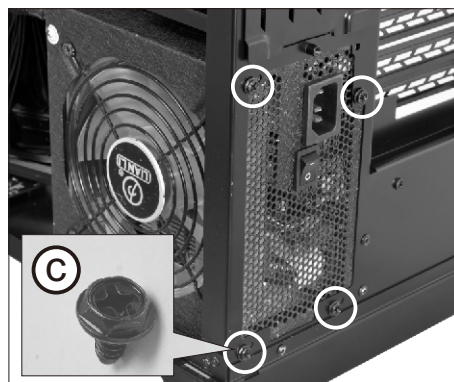
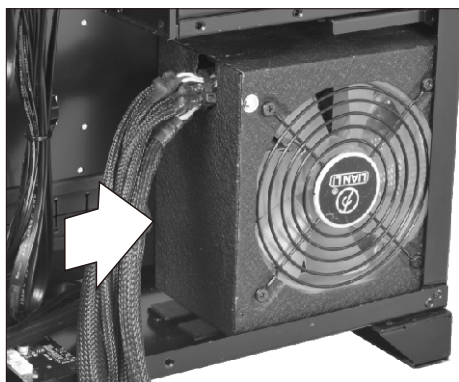

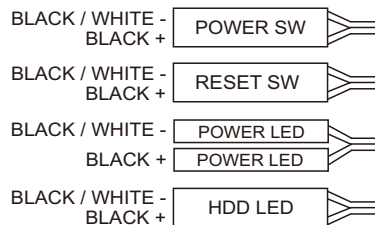

To install 2 more PSUs, remove the 2 hot swappable drive trays.

- * Cable installation guide
- * 電源/系統指示燈接線定義
- * Diagramme d'installation des câbles
- * Kabel installieren
- * Guía de instalación de los cables
- * マザーボード接続ケーブルに関して

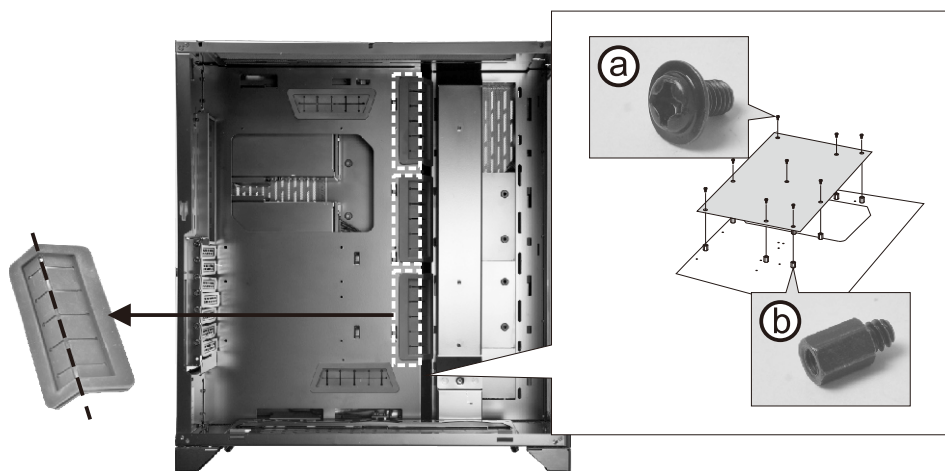

- * Motherboard installation
- * 主機板安裝
- * Installation de la carte mère
- * Motherboard installieren
- * Instalación de la placa base
- * マザーボードの取り付け



 To install a special spec MB (ex. MB including a LED module and/or a thicker shield), please trim the rubber pads.

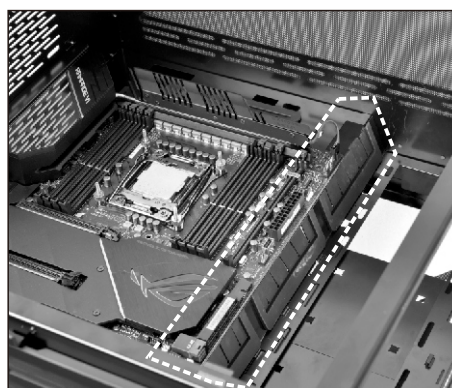
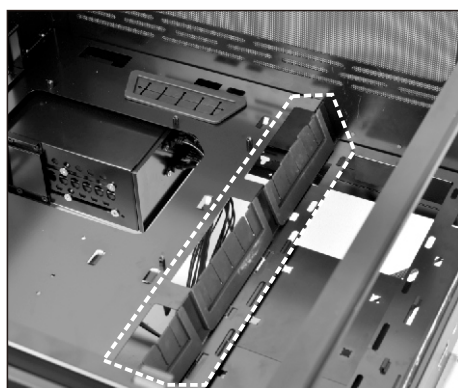

- * 2.5" SSD / 3.5" HDD installation
- * 2.5" SSD / 3.5" HDD 安裝
- * Installation de 2.5" SSD / 3.5" HDD

- * 2.5" SSD / 3.5" HDD-Installation
- * Instalación de 2.5" SSD / 3.5" HDD
- * 2.5" SSD / 3.5" HDD のインストール

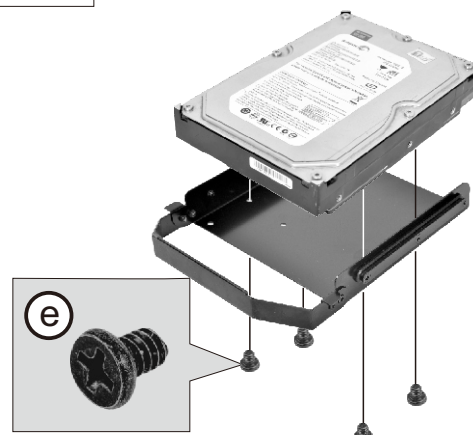
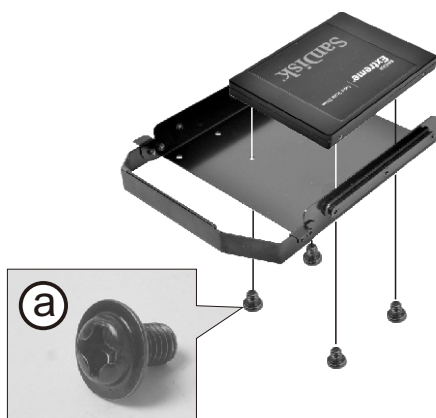
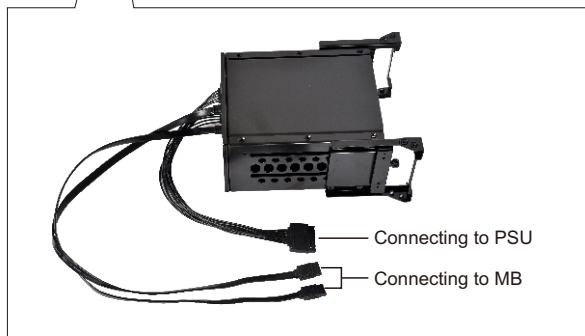
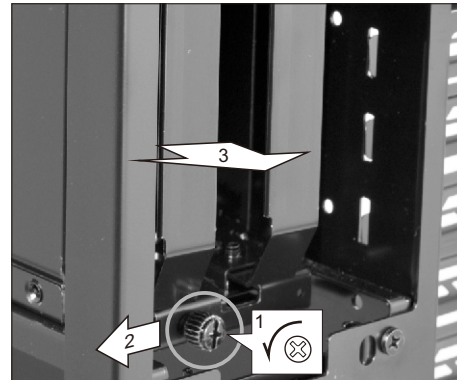
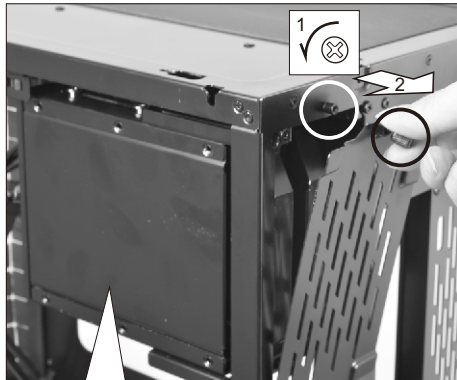

- * 2.5" SSD installation
- * 2.5" SSD 安裝
- * Installation de 2.5" SSD
- * 2.5" SSD-Installation
- * Instalación de 2.5" SSD
- * 2.5" SSD の取り付け



Press to release the HDD tray

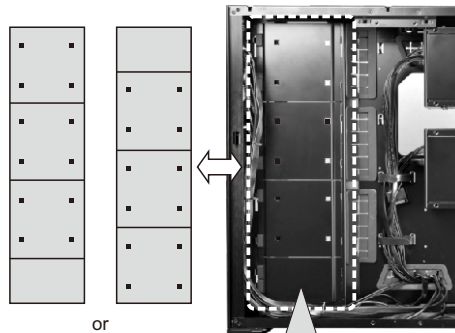
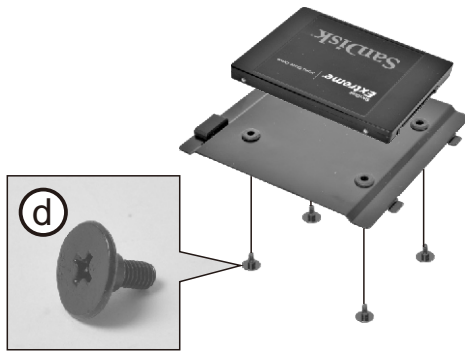

3+1 additional SSD trays can be installed on the front right side and/or on the removable fan/SSD tray on the bottom

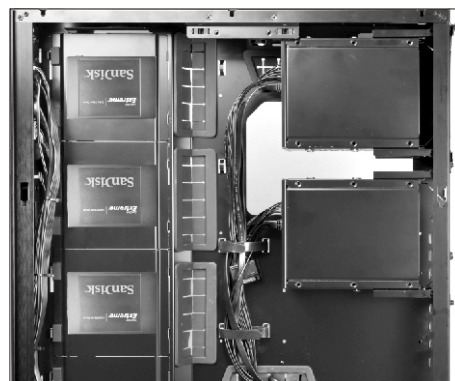
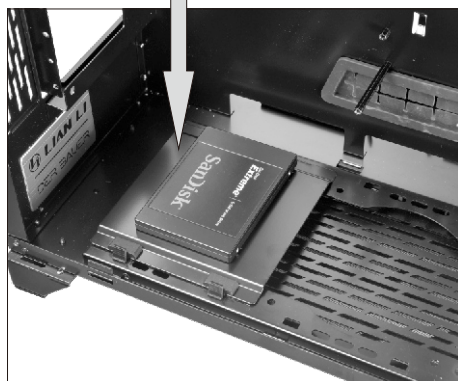

- * 2.5" SSD installation
- * 2.5" SSD 安裝
- * Installation de 2.5" SSD

- * 2.5" SSD-Installation
- * Instalación de 2.5" SSD
- * 2.5" SSDの取り付け

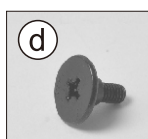
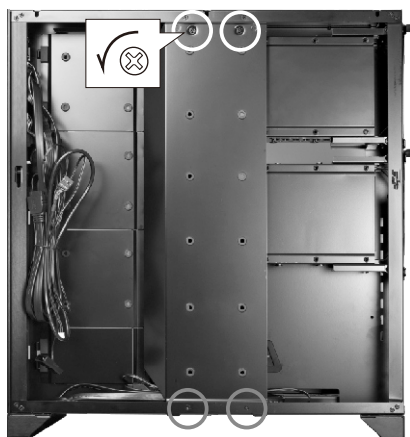

- * Cable management
- * 整線
- * Gestion des câbles
- * Kabelmanagement
- * Mantenimiento de cable
- * ケーブル管理

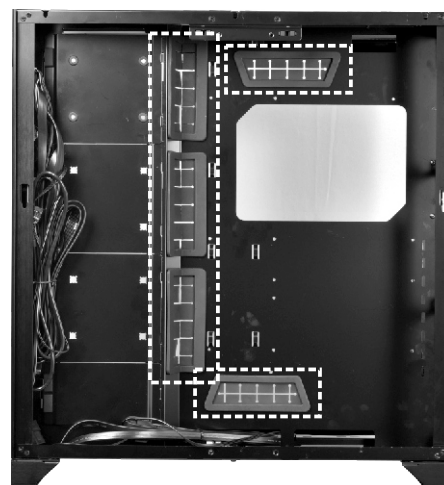
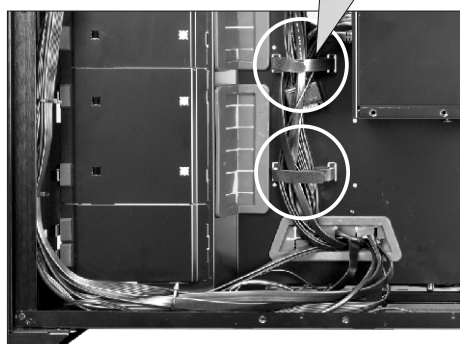

- * Remove the magnetic dust filters
- * 灰塵濾網拆卸
- * Retirez les filtres à air
- * Entfernen Sie Luftfilter
- * Retire los filtros de aire
- * エアフィルターの取り外し

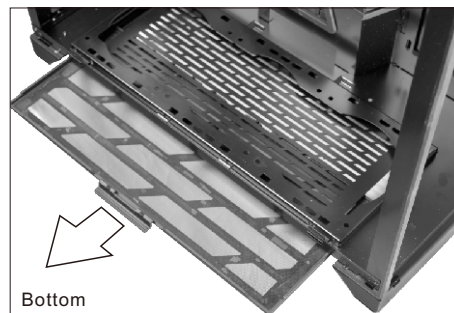
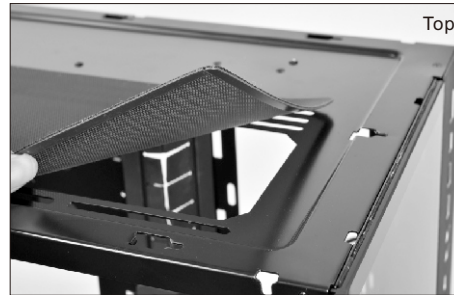
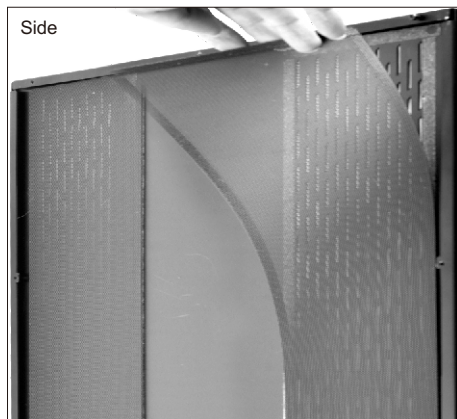

- * I/O ports function
- * I/O port 功能説明
- * Installation du port E/S
- * I/O-Port installieren
- * Instalación de los puertos de E/S
- * I/O ポートに関して

HD AUDIO

Blue	10	9	Green	
Black	purple	8	7	Key
Yellow	6	5	Orange	
Gray	4	3	N.C.	
Red	2	1	GND+H.S. TUBE	



USB 3.1 GEN.2

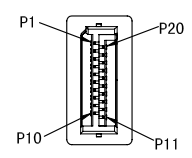

USB 3.0

Supports motherboard USB 3.0 20 Pin header

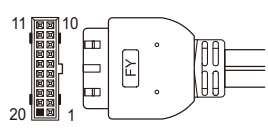

— Mode
8 Lighting Effects:
1. 1st-7th: MCU Built-in Lighting Mode
2. 8th: Sync Up the ARGB Lighting With The Motherboard
(1) Connecting The Header To The Motherboard
(2) To Turn Off The Lighting, Press The Button For 3 Sec. To Turn It On, Press Again For 3 Sec

C- Color
Press C To Control The 7 Built-in Static Colors

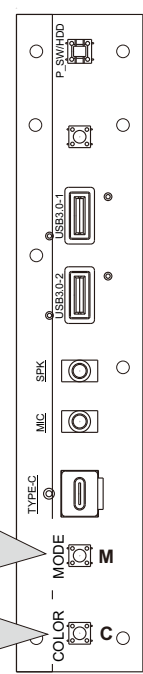

- * LED control board installation
- * LED控制板安裝
- * Installation du tableau de commande LED
- * Installation der LED-steuerplatine
- * Instalación del tablero de control LED
- * LEDコントロールボードの設置

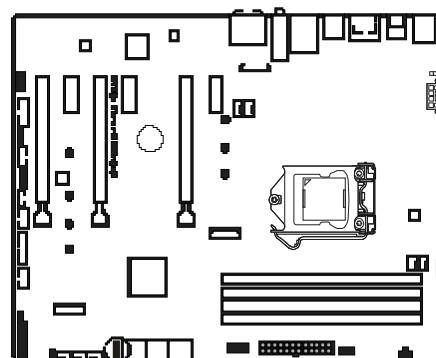
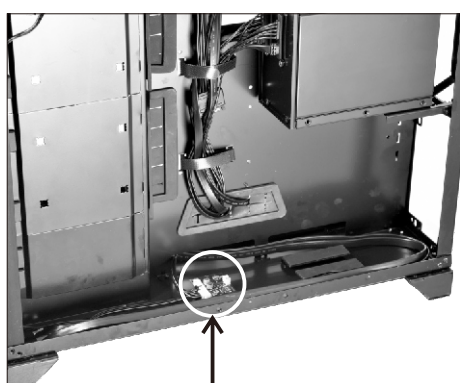

ADDRESS LED HEADER

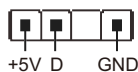

+5V D GND



Connecting to MB

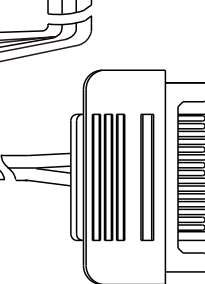
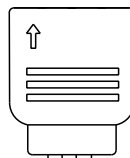

Connecting to PSU

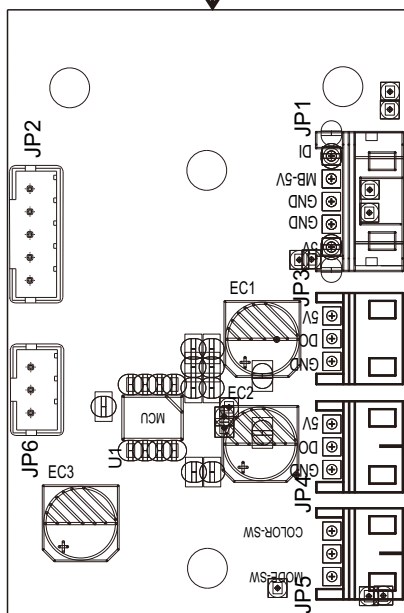

Already connected to the ARGB LED strip on the front

Putting the header of M/C button into this header

- * Graphics Card Anti-Sag Bracket (GB-001) installation
- * 顯示卡支撐架安裝說明
- * Carte Graphique installation du Support Anti-Affaissement
- * Grafikkarten-Anti-Durchhang-Halterung
- * Tarjeta Gráfica de montaje en Soporte Antideslizamiento.
- * グラフィックカード垂れ防止ブラケットの取り付け

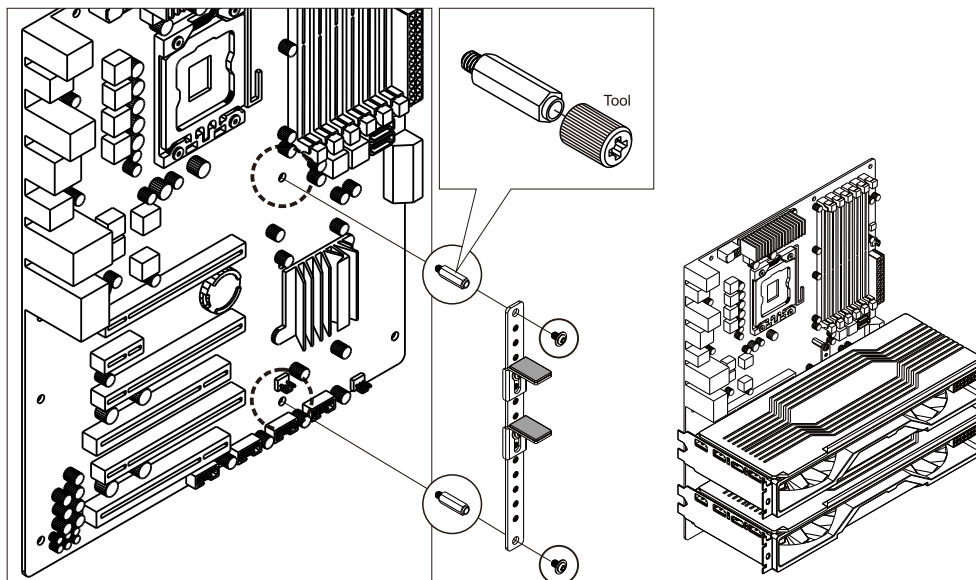
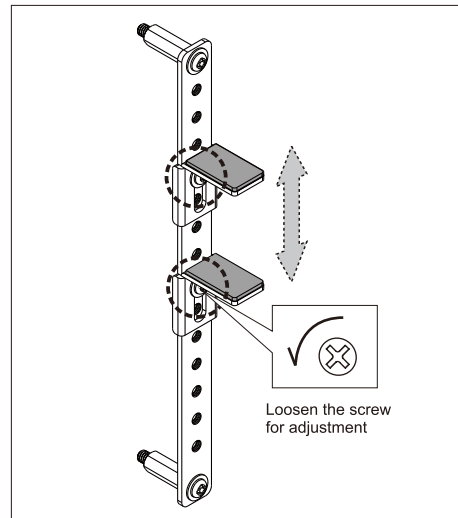
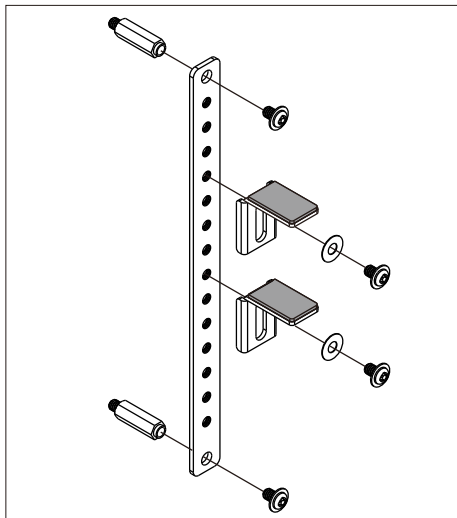

- * Radiator & cooling support
- * 散熱器 & 水冷排支援
- * Assistance radiateur et refroidissement

- * Kühler- und Kühlungsunterstützung
- * Radiador y soporte de refrigeración.
- * ラジエーター & 冷却サポート

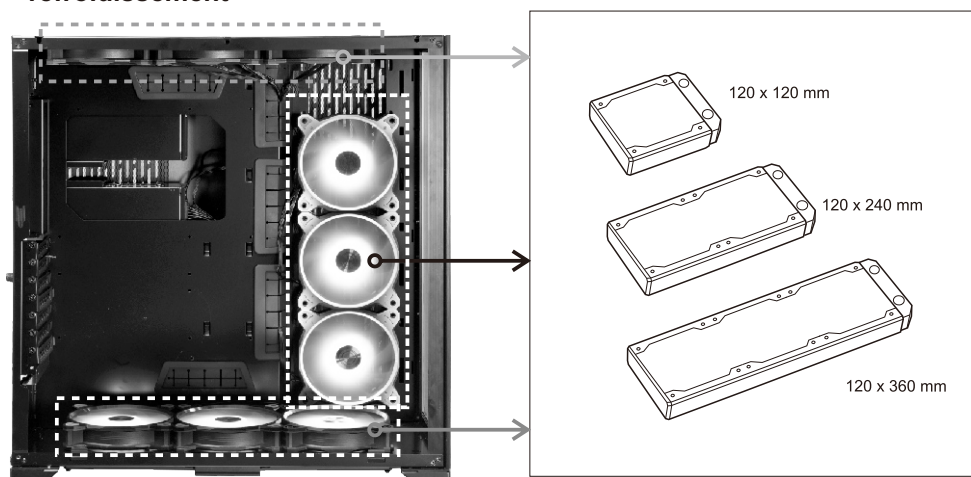

- * Optional kits
- * 選配套件
- * Kits optionnels

- * Optionale Sets
- * Kits opcionales
- * オプションパーツ

Model: O11DXL-1
Upright Display Card Kits
 200 mm PCI-e Express 16X Riser Card
 Adapter Extender Cable Kit.

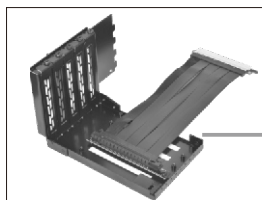

Model: O11DXL-2
Extension panel
 For EEB sized MB installation.





O11 DYNAMIC XL

*** Hardware clearance**
*** 硬體擴充支援**

- CPU air cooler
- GPU
- PSU
- Radiator clearance

*** Passage de matériel**
*** Hardware-Freigabe**

*** Limpieza de hardware**
*** ハードウェア拡張のサポート**

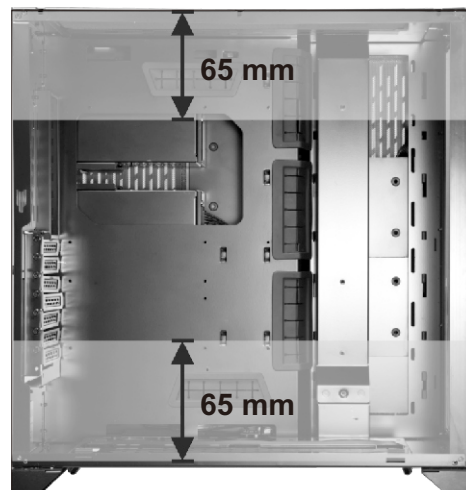
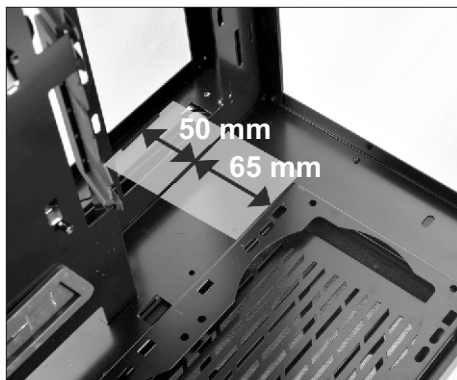
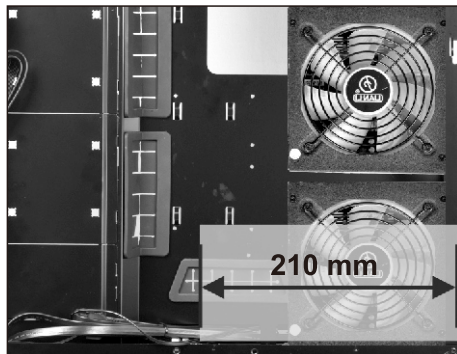
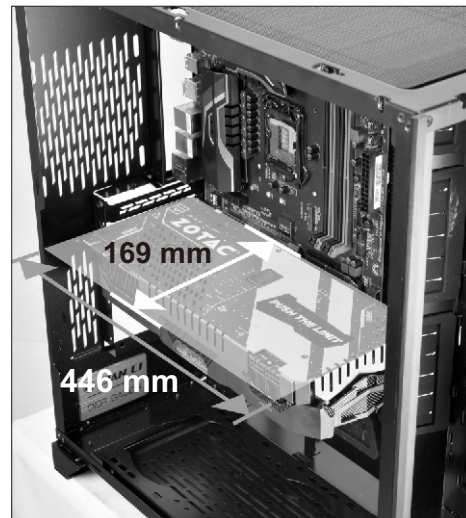
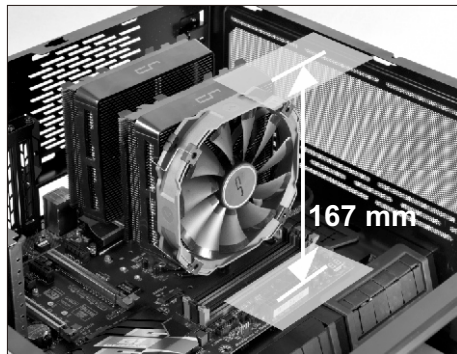



<http://www.lian-li.com>

G50.O11DROG0.00