



USER MANUAL

Moisture Meter, MSX® IR Camera, Hygrometer

Model MR277





USER MANUAL

Moisture Meter, MSX® IR Camera, Hygrometer

Table of contents

1	Advisories	1
	1.1 Copyright.....	1
	1.2 Quality Assurance	1
	1.3 Documentation	1
	1.4 Disposal of Electronic Waste	1
2	Introduction	2
3	Safety	4
	3.1 Safety Warnings and Cautions.....	4
4	Descriptions	5
	4.1 Product Description.....	5
	4.2 Control Button Descriptions	6
	4.3 Display Description	6
5	User Interface Menus	8
	5.1 Menu Structure Overview	8
	5.2 Main Menu Icons	8
	5.3 Temperature Scale Menu	9
	5.4 Image Mode Menu.....	10
	5.5 Measurement Menu	12
	5.6 Moisture Modes Menu	14
	5.7 Color Menu	16
	5.8 Settings Menu.....	17
6	Powering the MR277	23
7	Moisture Measurement Operation	24
	7.1 Moisture Measurements Basics	24
	7.2 Moisture Display Options.....	25
	7.3 IGM™ Moisture and IGM™ Custom Modes.....	27
	7.4 Moisture Measurement Modes	28
	7.5 Pinless Moisture Measurements	31
	7.6 Pin Probe Measurements	31
	7.7 MR12 Ball Moisture Probe (Optional).....	32
	7.8 Set Reference Mode	33
	7.9 High Moisture Alarm.....	34
8	Thermal and Visible Camera Operation	36
	8.1 Thermal Camera	36
	8.2 Automatic/Lock Temperature Scaling	38
	8.3 Digital (Visible) Camera	39

Table of contents

8.4	High/Low Radiometry (Temperature) Alarms.....	39
9	Ambient Temperature and Humidity Measurements	41
9.1	Temperature & RH Measurements and Dew Point, Vapor Pressure, and Mixing Ratio Calculations	41
9.2	Progressive Environmental Stability Indicator for RH %.....	42
10	Capturing and Working with Screen Captures.....	43
10.1	Capturing Images	43
10.2	Viewing Images on the MR277	43
10.3	Deleting images	43
10.4	Transferring Images via PC Interface.....	43
10.5	Transmitting Images and Data via Bluetooth®.....	44
11	Bluetooth® Communication and FLIR Tools™	45
11.1	FCC Compliance	45
12	Field Firmware Updates	47
12.1	System Firmware Update	47
13	Maintenance	48
13.1	Cleaning	48
13.2	Battery Service	48
13.3	Disposal of Electronic Waste	48
13.4	MR277 Crash Recovery	48
14	Specifications.....	49
14.1	General Specifications.....	49
14.2	Imaging Specifications.....	49
14.3	Moisture Meter Specifications	50
14.4	Visible Spectrum Camera Specifications.....	50
14.5	Safety Specifications	51
14.6	MR13 Sensor Measurement and Calculation Specifications	51
15	Appendices	52
15.1	Material Groups	52
	15.1.1 Common names of timbers	52
	15.1.2 Botanical names of timbers	55
15.2	%WME Table (% Wood Moisture Equivalent).....	58

Table of contents

16 Limited 10-Year Warranty 60
17 Customer Support..... 61
 17.1 Corporate Headquarters 61

1 Advisories

1.1 Copyright

©, FLIR Systems, Inc. All rights reserved worldwide. No parts of the software including source code may be reproduced, transmitted, transcribed or translated into any language or computer language in any form or by any means, electronic, magnetic, optical, manual or otherwise, without the prior written permission of FLIR Systems.

The documentation must not, in whole or part, be copied, photocopied, reproduced, translated or transmitted to any electronic medium or machine-readable form without prior consent, in writing, from FLIR Systems. Names and marks appearing on the products herein are either registered trademarks or trademarks of FLIR Systems and/or its subsidiaries. All other trademarks, trade names or company names referenced herein are used for identification only and are the property of their respective owners.

1.2 Quality Assurance

The Quality Management System under which these products are developed and manufactured has been certified in accordance with the ISO 9001 standard.

FLIR Systems is committed to a policy of continuous development; therefore, we reserve the right to make changes and improvements on any of the products without prior notice.

1.3 Documentation

To access the latest manuals and notifications, go to the Download tab at: <https://support.flir.com>. It only takes a few minutes to register online. In the download area you will also find the latest releases of manuals for our other products, as well as manuals for our historical and obsolete products.

1.4 Disposal of Electronic Waste



As with most electronic products, this equipment must be disposed of in an environmentally friendly way, and in accordance with existing regulations for electronic waste. Please contact your FLIR Systems representative for more details.

2 Introduction

Thank you for selecting the FLIR MR277. The MR277 integrates high quality thermal imaging and digital camera technology with best-in-class moisture detection and measurement. The MR277 includes an integrated noninvasive pinless moisture sensor, an external pin moisture probe (MR02), and a replaceable temperature and relative humidity ambient sensor (MR13). The MR277 also provides dew point, vapor pressure, and mixing ratio calculations.

The MR277 features Infrared Guided Measurement (IGM™) technology that allows you to quickly scan and target problem areas. The MSX® feature (Multi-Spectral Dynamic Imaging) superimposes the digital camera image on the thermal image providing valuable image detail.

The MR277 stores camera images (with measurement data) for later transfer to a PC (via USB). Images can also be transmitted to mobile devices using the Bluetooth® utility running the FLIR Tools™ App.

Visit <https://www.support.flir.com> to find additional accessories and to register the MR277 which extends the standard one-year warranty to the 2-10 Year Warranty.







Features

- FLIR Lepton® microbolometer Focal Plane Array (FPA) with integrated shutter delivers best-in-class thermal imaging
- Quickly scan for moisture using the integrated noninvasive pinless moisture sensor
- External pin probe (included) for resistive moisture content measurements
- Ambient air temperature and relative humidity readings from field replaceable sensor
- IGM™ Moisture mode shows both the thermal image and moisture readings on one screen
- IGM™ Custom mode allows user to select which moisture and psychrometric readings to display
- MSX® feature superimposes the digital camera image on the thermal image
- Psychrometric mode displays ambient air temperature, relative humidity, dew point, mixing ratio, and vapor pressure
- Moisture-only mode shows Pin or Pinless moisture readings in large-digit format
- Temperature Scale Lock adds precision to thermal image scanning

- Easily capture, view, download (to PC), send to mobile devices, and delete camera images
- Selectable material groups allow you to fine tune pin-based measurements
- Programmable high moisture alarm and high/low radiometry alarm with audible and color-coded display alerts
- Laser pointer and display cross hairs for enhanced targeting
- Easy to read, color display with intuitive graphical interface and tool tips in local languages
- Internal rechargeable battery via USB connection to AC charger

3 Safety

3.1 Safety Warnings and Cautions

 WARNING
Before operating this device, please read, understand, and follow all operational instructions and safety warnings.
 CAUTION
Use of controls or adjustments or performance of procedures other than those specified herein may result in hazardous radiation exposure.
 CAUTION
Use extreme caution when the Laser pointer is on.
 CAUTION
Do not point the Laser beam toward anyone's eye or allow the beam to strike the eye from a reflective surface.
 CAUTION
Do not use the Laser near explosive gases or in other potentially explosive areas.
 CAUTION
Refer to the CAUTION statement label (shown below) for critical Laser safety information.

4 Descriptions

4.1 Product Description

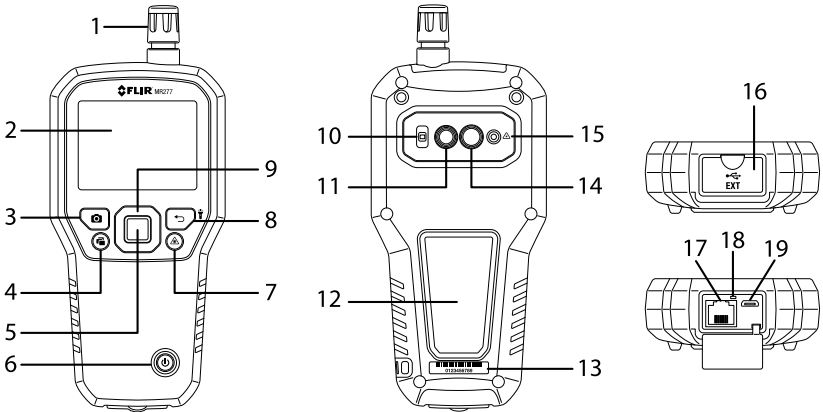









Figure 4.1 Front, Back, and Bottom Product Description

1. Temperature and Relative Humidity Sensor (MR13)
2. Color Graphical Display
3. Image Capture button
4. Image Gallery button
5. *Select* button (center). Press to open Menu
6. Power button
7. Laser Pointer button
8. *Return* and *Worklight* button
9. Navigation buttons (UP, DOWN, LEFT, RIGHT)
10. Worklight lens
11. Digital camera lens
12. Pinless moisture sensor pad
13. Serial number label
14. Thermal camera lens
15. Laser pointer lens
16. External probe and USB jack compartment
17. External moisture probe RJ jack
18. Battery charging LED
19. USB jack for connecting to PC or AC Charger

4.2 Control Button Descriptions

	Long press to power ON or OFF.
	Return button. Short press to back out to previous screen in Menu system.
	Long press to switch Worklight ON or OFF.
	Press the <i>Select</i> button (center) to access the Main Menu and to select items in the menu system. Use the outer navigation (ring) buttons to move Up-Down-Left-Right.
	Press to switch the Laser pointer ON.
	Press to capture screen image.
	Press to open image gallery.

4.3 Display Description

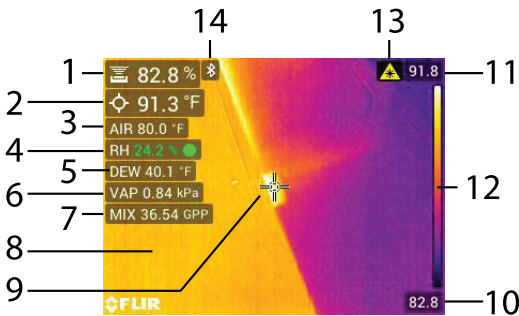

Figure 4.2 MR277 Select Display Descriptions

1. Moisture reading
2. Temperature of targeted center spot (cross hairs)
3. Air temperature (from probe measurement)
4. Relative humidity (from probe measurement)
5. Dew point temperature calculation
6. Vapor Pressure calculation in kilo-Pascals (kPa)
7. Mixing ratio calculation in grains per pound (GPP)



8. IR Thermal image
9. Cross-hairs (Center Spot)
10. Low end of IR image temperature range
11. High end of IR image temperature range
12. Temperature scale
13. Laser pointer active icon
14. Bluetooth® active icon

**NOTE**

Not all icons are represented in Figure 4–2. Other available icons are explained in their respective sections of this user manual.

5 User Interface Menus

5.1 Menu Structure Overview

When the *Select* button  is pressed, six menu icons appear along the bottom of the MR277 display. Use the left/right navigation buttons to move to a menu icon, and use the *Select* button to open a selected menu. Once a menu is opened, the navigation and *Select* buttons are used to select modes of operations and settings. Use the *Return* button  to back out of a menu.

5.2 Main Menu Icons

From left to right, the six main menu icons are listed below and shown in **Figure 5-1**. Each menu is described in detail in the next sections.

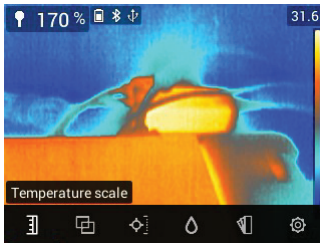







Figure 5.1 Main Menu icons at bottom of display. Press *Select* to reveal the icons.

1. Temperature scale 
2. Image modes 
3. Measurement modes 
4. Moisture modes 
5. Color (palette) choices 
6. Settings menu 

5.3 Temperature Scale Menu

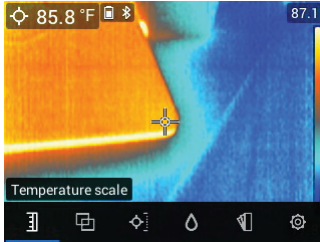

Figure 5.2 Accessing the Temperature Scale Menu

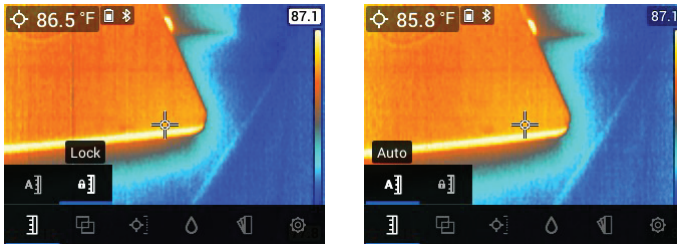



Figure 5.3 Selecting AUTO or LOCK Scaling

The Temperature scale menu allows you to select Automatic (Auto) or Lock scaling. Use the navigation buttons to move to the desired setting and then press *Select*  to confirm.

In Automatic mode, the MR277 automatically selects the temperature range for each thermal image, based on the highest and lowest temperatures detected. In Lock mode, you can ‘lock in’ a particular thermal image’s temperature range and use this locked range for subsequent thermal image comparisons. This locked range does not change, regardless of the highest and lowest temperatures detected for the subsequent images. See **Section 8–2 Automatic and Lock Scaling** for more information.

To release the Lock mode, simply select the Auto mode as described above.

5.4 Image Mode Menu

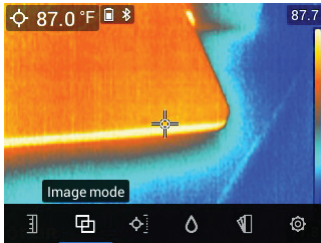



Figure 5.4 Six Main Menu icons

The Image Mode Menu offers six sub-menus as described below.

- Alignment Distance control:** This control allows you to adjust the superimposition of the visible image over the thermal image. This is the MSX® feature. Press *Select*  on the Alignment Distance menu to open it, and then use the navigation buttons to adjust the alignment. Press *Select* to confirm the change.

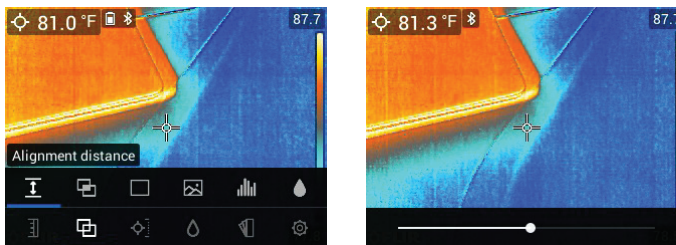

Figure 5.5 Alignment Distance Control screens

- Thermal MSX® mode:** Select this mode to see the digital camera image superimposed over the thermal camera image.

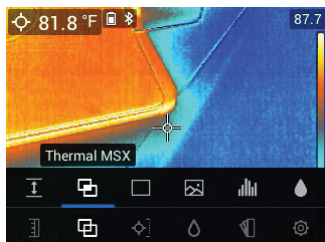

Figure 5.6 Thermal MSX® selection

- **Thermal mode:** Select this mode to see the thermal image only.

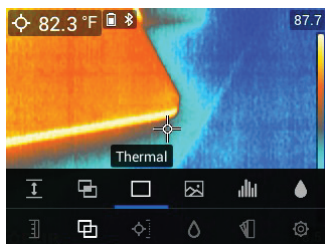

Figure 5.7 Thermal IR Image mode

- **Digital Camera mode:** Select this mode to see only the visible camera image.

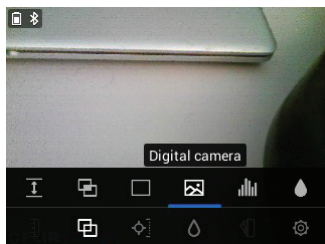

Figure 5.8 Digital Camera mode selection

- **Psychrometric readings:** Select this mode to see a dedicated view of the Relative Humidity and Temperature measurements that the supplied MR13 sensor provides. You can also view the Dew Point temperature, Mixing

ratio, and Vapor Pressure values, derived from the RH and Temperature measurements.

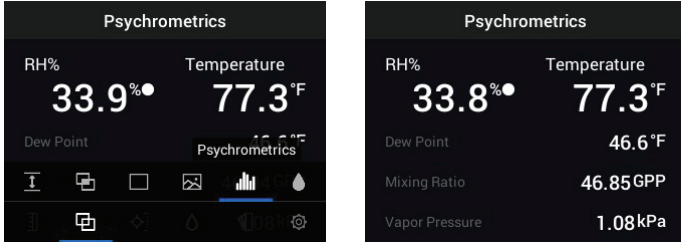

Figure 5.9 Psychrometrics mode selection and display example

- **Moisture mode:** Select this mode to see only the moisture reading in large digit format.

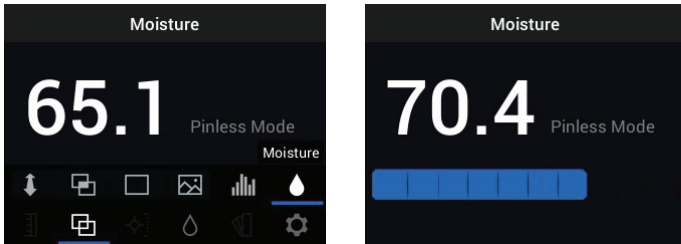

Figure 5.10 Moisture mode selection and example screen

5.5 Measurement Menu

The Measurement Menu offers four sub-menus as described below.

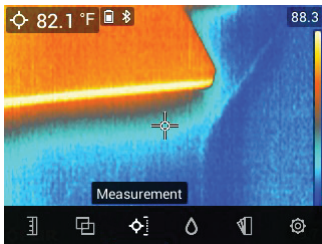

Figure 5.11 Selecting the Measurement mode from the main menu

- **No Measurements:** Select this mode if you do not wish to see any measurement values or icons on the display. Only the camera image will be seen in this mode.

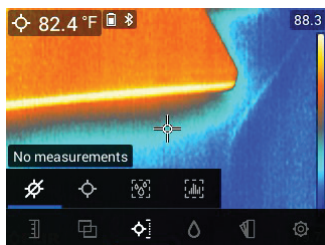

Figure 5.12 Selecting the 'No Measurement' mode from the main menu

- **Center Spot (cross-hairs):** Enable this mode to view the temperature measurement of the targeted spot in the upper left hand corner of the display. Use the cross-hairs to target the measurement spot.

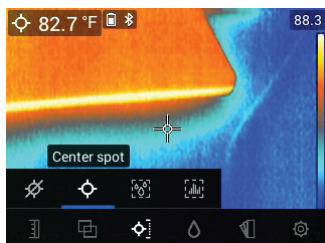

Figure 5.13 Selecting the 'Center Spot' mode from the main menu

- **IGM™ Moisture mode:** Select this mode to view the moisture measurements on the upper left hand corner of the display. The IGM™ mode (Infrared Guided Measurement) is best suited for first scanning an area for temperature measurements and then taking moisture measurements in the strategic areas identified by the temperature measurements.

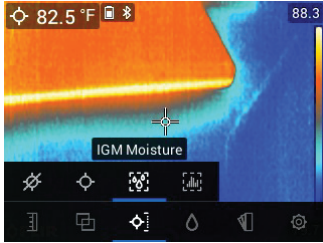

Figure 5.14 Selecting the IGM™ Moisture mode from the main menu

- **IGM™ Custom mode:** Select this mode to view all of the measurement types on the MR277 that you enable in the **Settings** menu (see **Section 5.8**).

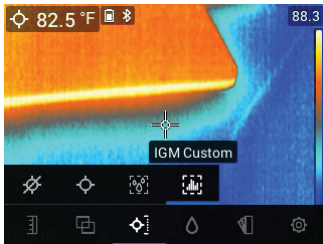

Figure 5.15 Selecting the IGM™ Custom mode from the main menu

5.6 Moisture Modes Menu

The Moisture Mode Menu offers five sub-menus as described below.

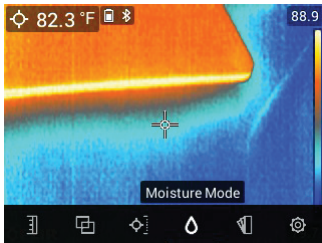

Figure 5.16 Opening the Moisture Mode menu

- **Material Group selection:** This mode is only available when the pinless mode is selected (below). Select Group 1 through Group 11 depending on

the material under test. See **Section 15 Appendices** for the Material Group selection tables that help you select the correct group number.

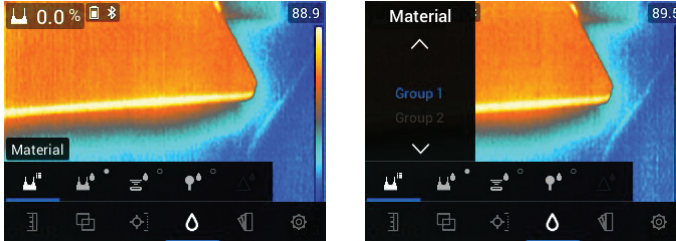

Figure 5.17 Selecting a Material Group for pin-based moisture measurements

- **Pin mode:** Select this mode when using an external pin probe. See **Section 7.6 External Pin Probe Measurements** for more information.

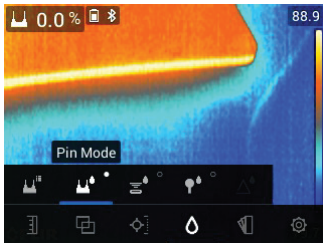

Figure 5.18 Selecting pin-based measurement mode

- **Pinless mode:** Select this mode when using the pinless sensor (rear of MR277). See **Section 7.5 Pinless Moisture Measurements** for more information.

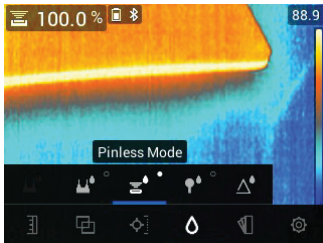

Figure 5.19 Selecting the pinless measurement mode

- **MR12 mode:** Select this mode when using the optional MR12 Ball Moisture probe accessory. The MR12 attaches to the RJ jack on the bottom of the MR277. See **Section 7.7 External Ball Moisture Probe** for more information.



Figure 5.20 Selecting the MR12 (optional moisture probe) mode

- **Set Reference mode:** This utility is only available when using the built-in pinless sensor (rear of MR277) or the remote MR12 Ball Moisture probe. After selecting the pinless mode (or the MR12 mode) and while taking a moisture measurement, select the 'Set Reference' utility to zero the current measurement value (the delta symbol will appear to inform you that the Set Reference mode is active). Now, subsequent moisture measurements can be made relative to the original 'Set Reference' value. To release the Set Reference utility, select the pin mode. See **Section 7.8 Set Reference Mode** for additional information.

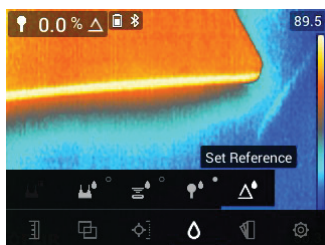

Figure 5.21 Selecting the reference value in which to compare subsequent measurements

5.7 Color Menu

The color menu allows you to select from five display palettes. Iron, Rainbow, White hot, Black hot, and Arctic.

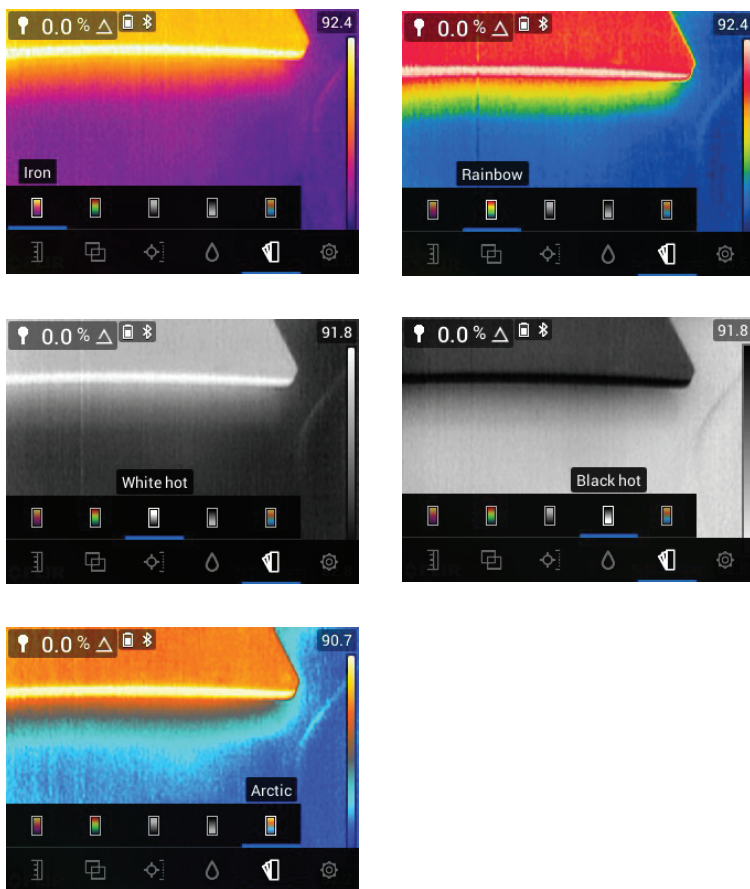

Figure 5.22 Color palette selections

5.8 Settings Menu

The Settings menu offers the following options:

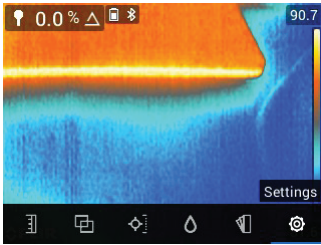

Figure 5.23 Selecting the 'Settings' mode from the main menu

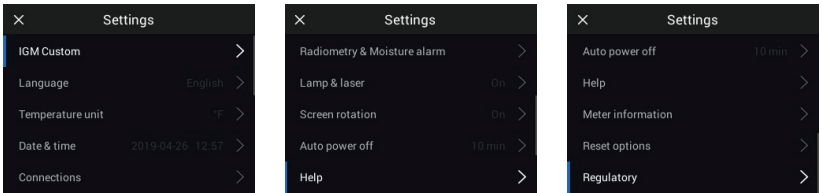

Figure 5.24 Settings menu

- **IGM™ Custom mode:** Select the readings that you wish to display when the IGM™ Custom Mode is enabled in the Measurement Menu, **Section 5.5**.

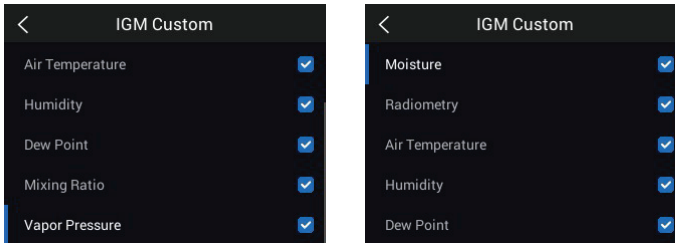



Figure 5.25 IGM™ Custom mode selections. Pick the items to display in the IGM™ mode

- **Language selection:** Use the navigation arrows and *Select* button  to choose the desired display language.

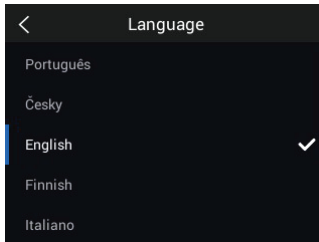

Figure 5.26 Local language selections

- **Temperature units selection:** Select °C or °F.

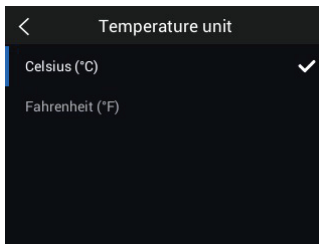

Figure 5.27 Selection temperature units of measure

- **Date and time setting:** Set the year, month, day, hours, and minutes.

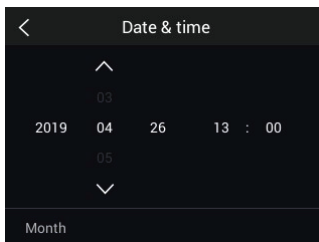

Figure 5.28 Setting the Date and Time

- **Connections:** Set Bluetooth® communications ON or OFF. See **Section 11 Bluetooth® Communication and FLIR Tools™** for more information.

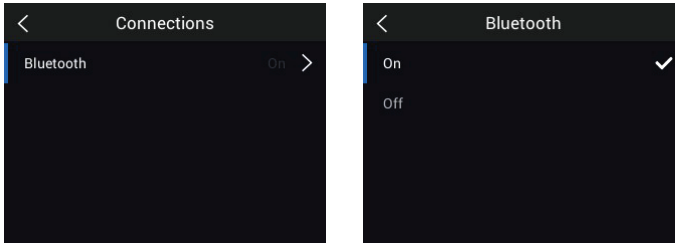

Figure 5.29 Setting Bluetooth® ON or OFF in the Connections menu

- Radiometry & Moisture Alarms:** Set the Radiometry (temperature) Alarm to ABOVE, BELOW, or OFF. When a Radiometry alarm is set to ABOVE or BELOW, the MR277 will alert you when the temperature exceeds the high limit (temperature display turns red) or falls below the low limit (temperature display turns blue). When a Radiometry alarm is set to OFF, the alarm is disabled.

Set the Moisture Alarm to ABOVE or OFF. When a Moisture alarm is set to ABOVE, the MR277 will alert you when the moisture measurement exceeds the high limit (moisture reading turns red and beeper sounds, if enabled). When a Moisture alarm is set to OFF, the alarm is disabled. The Moisture alarm utility also allows you to select BEEP or NO SOUND for the alarm alert. See **Section 7.9 High Moisture Alarm** and **Section 8.4 High/Low Radiometry Alarms** for more information.

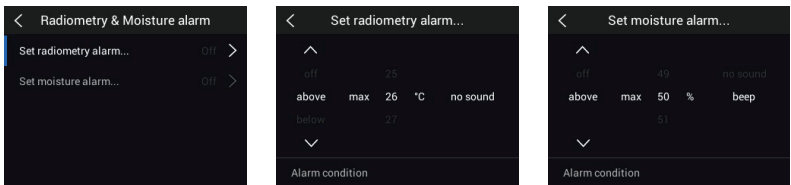



Figure 5.30 Setting Moisture and Radiometry Alarms

- Lamp and Laser Enable/Disable:** Enable or disable both the Worklight and Laser pointer. When enabled, press and hold the Worklight button  to turn the Worklight ON or OFF. When enabled, press the Laser button  to turn the Laser pointer ON (release the button to turn it OFF).

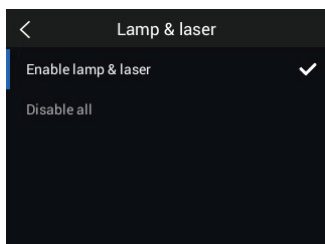

Figure 5.31 Enabling/Disabling the Laser pointer and the Worklight

- **Auto Power OFF (APO):** Set APO to a time value of 5, 10, 20, or 30 minutes. Set to OFF to disable APO.

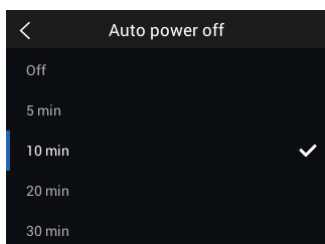

Figure 5.32 Setting the Auto Power Off (APO) utility

- **HELP Resources:** Access this menu to view customer support and training resources.

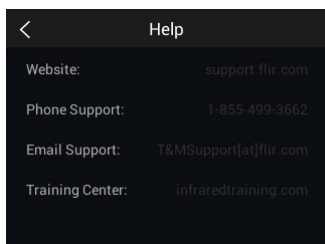

Figure 5.33 Viewing the Customer Support resources

- **Meter Information:** Access this menu to see Model number, Software version, Data storage availability, Battery status, and Calibration date information.

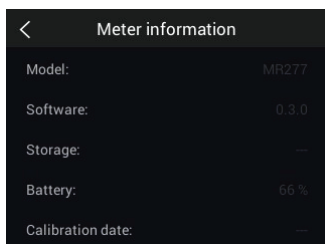

Figure 5.34 Checking the meter information screen

- **Reset options:** Access this menu to reset the MR277 to factory default conditions or to format (erase) the internal storage bank. To recover from a MR277 crash (display freezes), press and hold the UP and DOWN arrows for >10 seconds, until the MR277 reboots. No data will be lost by running this procedure.





Figure 5.35 Reset options screen

- **Regulatory information:** Access this menu to view Laser safety information.



Figure 5.36 Viewing safety information for the Laser pointer

6 Powering the MR277

1. Long press the Power button  to switch the meter ON. The FLIR logo will appear and the meter will proceed to power up. Long press again to power OFF.
2. If the battery status indicator  shows that the battery voltage is low or if the meter does not power ON, charge the battery by connecting the meter to an AC charger using the supplied USB cable. When the MR277 is not charging, the battery status indicator is only visible from the Main Menu (press *Select*  to access the Main Menu). While charging, the battery status indicator is always visible. Note that there is an indicator in the bottom compartment, next to the USB jack, that illuminates when the MR277 is charging.
3. The meter switches OFF automatically after a programmed period of inactivity (unless APO is set to OFF in the 'Settings' menu, see **Section 5.8 Settings Menu** for more information). Press any button to reset the APO timer when you hear the three warning beeps. If no buttons are pressed during the warning beeps, the MR277 will power OFF. To disable APO, or to change the APO timer value, edit the APO parameter in the 'Settings' menu.
4. The internal battery is not user-serviceable. If you find that the battery will not charge, see the **Section 13.2 Battery Service** for further instructions and to learn about the proper charging techniques for when the meter is to be stored for extended periods. Failure to follow these instructions can result in a battery that cannot be charged and that will require factory service.

7 Moisture Measurement Operation

7.1 Moisture Measurements Basics

Moisture measurements are performed using the internal pinless moisture sensor (rear) or by connecting an external probe, such as the supplied MR02 pin probe or the pinless MR12 Ball Moisture probe, to the RJ jack at the bottom of the meter. Other external probes are available optionally; please visit <https://www.flir.com> for details. The MR277 has a dedicated MR12 utility where you connect the probe and select the MR12 icon in the ‘Moisture Mode’ menu: *Select* button/Moisture mode/MR12.

	NOTE
Objects in close proximity to the internal pinless moisture sensor (rear of the unit) will affect measurements; Keep hands and objects away from the sensor when taking measurements.	

Moisture readings are shown in large digits and bar graph in the Moisture-only mode or in small digits (upper left hand corner) in all other modes, see **Section 5-4 Image Mode Menu** for additional information. See **Figure 7-1** below for screen shot examples.

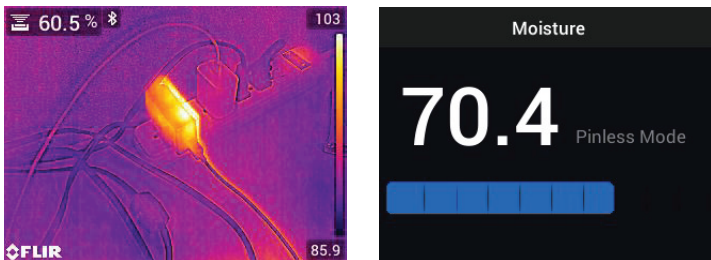





Figure 7.1 Moisture reading upper left corner (LEFT); Moisture reading in Moisture-only mode (RIGHT)

Pinless measurement readings are ‘relative’ scaled (0~100). Pin-based readings are represented in %MC (moisture content) for wood and %WME (wood moisture equivalent) for non-wood materials; additional information is provided in **Section 7-6, External Pin Probe Moisture Measurements** and in the Specifications section.

Moisture measurements are covered in detail in the following sections. Be sure to select Pin Mode  or Pinless Mode  in the 'Moisture' menu  to match the measurement type.

7.2 Moisture Display Options

View moisture readings in two basic ways. **1.** Moisture readings as large digits in the Moisture-only mode or **2.** Moisture readings in small digits in the upper left hand corner of a thermal or visible camera image. Choose the desired mode in the menu (*Image Mode*). Refer to the information below and to **Section 5-4 Image Modes** for additional details.

- **Thermal MSX® mode** (Multi-Spectral Dynamic Imaging). The digital camera image is superimposed on the thermal image to give greater detail to the thermal image. The moisture reading can be seen on the upper left. See **Section 5-4 Image Modes** for aligning the digital camera image over the thermal image (Alignment Distance Control).

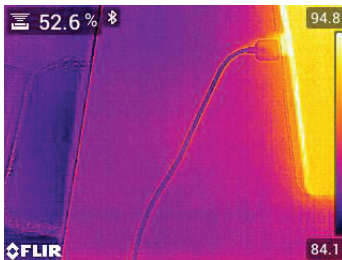

Figure 7.2 Thermal MSX® mode with Moisture reading in the upper left corner

- **Thermal Mode.** This is the thermal image only. The moisture reading can be seen on the upper left.

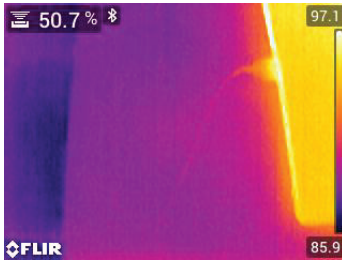

Figure 7.3 Thermal mode with Moisture reading in the upper left corner

- **Digital Camera:** This is the digital camera image only. The moisture reading can be seen on the upper left.

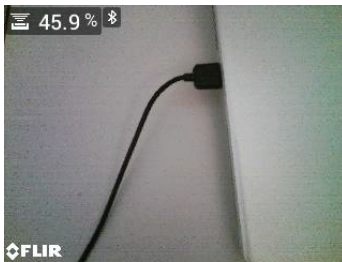

Figure 7.4 Digital Camera mode with Moisture reading in the upper left corner

- **Psychrometrics mode:** Moisture readings are not displayed on this screen but this mode is included here since you'll come across it when scrolling through the image mode selections. See **Section 5-4 Image Modes** and **Section 9 Ambient Temperature and Relative Humidity Measurements** for detailed information on Psychrometrics.

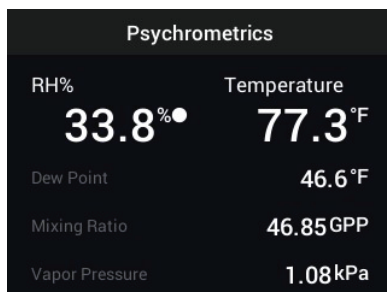

Figure 7.5 Psychrometrics display mode

- **Moisture mode.** This is a dedicated display for moisture only. Large digits and a bar graph are used in this mode for easy viewing. Additional features in this mode include color coded alarm alert (see **Section 7.9 High Moisture Alarm**) and relative readings (see **Section 7.8 Set Reference**).

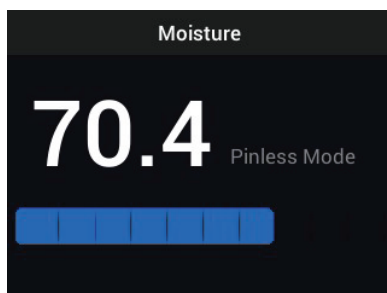



Figure 7.6 Moisture-only display mode

7.3 IGM™ Moisture and IGM™ Custom Modes

In the **IGM™ Moisture** mode  you can view a camera image with the Moisture reading appearing on the upper left. Select this mode in the menu (*Measurement/IGM™ Moisture*). IGM™ stands for 'Infrared Guided Measurements'. The Pin or Pinless display icon will appear next to the reading. To take full advantage of this feature, scan for temperature variations, and use this feedback to help you find areas of high moisture. For additional information see **Section 5.5 Measurement modes**.

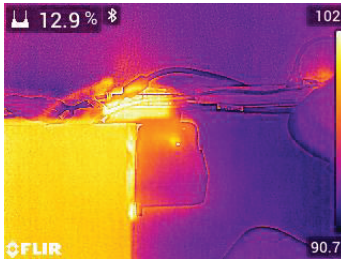



Figure 7.7 IGM™ mode with Moisture reading shown on upper left

In the **IGM™ Custom** mode , the same benefits apply to the discussion above for IGM™ Moisture mode with the added benefits of displaying Air Temperature, Relative Humidity, Vapor Pressure, Mixing Ratio, and Dew Point Temperature on the camera image. To select which of these parameters to display, use the Settings menu (*Settings/IGM™ Custom*).

For additional information see **Section 5.5 Measurement modes**.

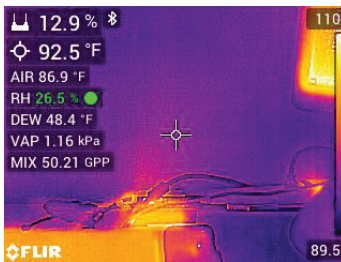



Figure 7.8 IGM™ Custom mode with Moisture reading on upper left and Psychrometrics directly below

7.4 Moisture Measurement Modes

Press the **Select**  button to open the Main Menu, choose the ‘Moisture’

mode , and then select from the four Moisture mode options as described below.

- **Material Groups**

Select a Material Group that best matches the material under test. This applies only for external pin-based probe use. Use the menu to make a

selection (*Moisture Mode/Material* ). Use the Navigation arrows to scroll through the Material list and press *Select*  to choose the Group number. See the Material Group tables in **Section 15 Appendices**, these tables will help you decide which Material Group to select.

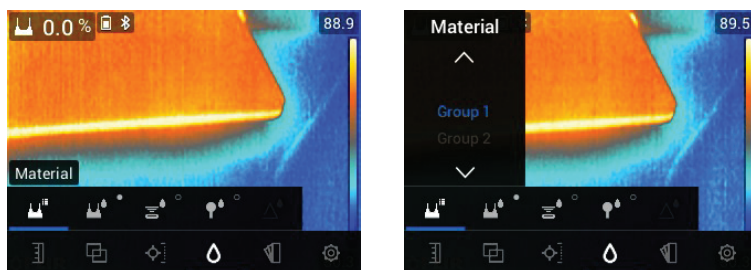



Figure 7.9 Selecting a Material Group in the 'Moisture' menu

- **Pin Mode**

PIN mode must be selected in the menu (*Moisture mode* ) when an external pin-based probe is used. Note the pin icon on the upper left of the main display when selected. Pin-based readings are represented in %MC (moisture content) for wood and %WME (wood moisture equivalent) for materials other than wood.

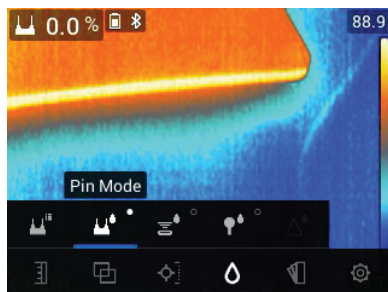



Figure 7.10 Pin mode menu selection

- **Pinless Mode**

Pinless mode must be selected in the menu when using the internal sensor (*Moisture mode* ). Note the pinless icon on the upper left of the main display when selected. Pinless measurement readings are 'relative' scaled (0~100).

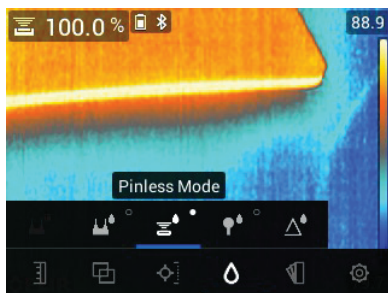

Figure 7.11 Pinless mode selection

- **MR12 Mode**

MR12 mode must be selected when the optional MR12 Ball Moisture probe is used. Connect the MR12 to the accessory RJ jack on the bottom of the MR277 (under the protective flap) and then select the MR12 from the Moisture Mode menu as shown in **Figure 7-12**.

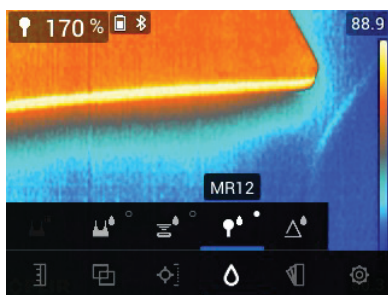

Figure 7.12 Selecting the MR12 (optional Ball Moisture probe) mode

- **Set Reference Mode**

'Set Reference' is used to compare measurements to a stored reference value. This mode applies only to readings taken with the pinless internal sensor or the external MR12 Ball Moisture probe. The moment the Set

Reference mode is selected, the current reading is offset to zero. Subsequent readings will be offset by this same amount, see **Section 7.8 Set Reference Mode** for additional information.

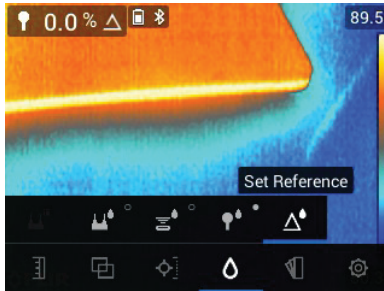

Figure 7.13 Selecting the 'Set Reference' mode.

7.5 Pinless Moisture Measurements

- Select the pinless mode from the menu system (*Moisture mode/Pinless*); see **Figure 7-11** above).
- Place the internal moisture sensor (back) on the surface of the material to be tested. Apply light pressure to ensure that the internal sensor is completely flat against the surface of the material under test.
- The internal moisture sensor detects moisture to a depth of approximately 19 mm (0.75"). The actual depth will vary depending upon the amount of moisture, the material under test, surface roughness, and other factors.
- Pinless measurement readings are 'relative' scaled (0~100).
- The moisture reading is displayed on the main display in the upper left hand corner (thermal and camera image modes) or as large digits (Moisture-only mode). Refer to **Section 5.4 Image Modes** and **Sections 7.2** through **7.4**, for more information.
- Keep hands, surfaces, and objects away from the internal moisture sensor on the back of the MR277 when taking measurements.
- For best results, lift the meter off the surface under test between measurement points; do not drag the meter over surfaces.

7.6 Pin Probe Measurements

1. Select the Pin mode from the menu (*Moisture mode/Pin Mode*); see **Figure 7-10** above.

2. Connect the supplied MR02 pin probe, or other external pin probe, to the meter's RJ jack at the bottom of the meter (under the protective flap). Refer to <https://www.flir.com> for available moisture probes.
3. Select the appropriate Material Group in the menu system (*Moisture mode/Material*) as described in **Section 7.4 Moisture Measurement modes**. Also, See **Section 15 Appendices** for information on Material Groups and the associated Group numbers to choose from in the menu.
4. Press the pins into the material under test.
5. Pin-based readings are represented in %MC (moisture content) for wood and %WME (wood moisture equivalent) for materials other than wood.
6. The moisture reading is displayed on the main display (%) in the upper left hand corner (Thermal and Digital Camera images) or as large digits (Moisture-only mode). Use the menu to select the Image mode (Image mode

**NOTE****Pin Probe Moisture Measurement Considerations**

The MR277 will display accurate external pin probe readings in the 7% to 30% range, depending on the tested material. Moisture Content readings below 6% will display as 0% for all materials and the maximum specified range is dependent on the fiber saturation point for specific species. Above the fiber saturation point, the reading can only be used as a relative reference value.

For more information on fiber saturation please refer to public document ASTM D7438. For additional information on Pin moisture measurement accuracy please refer to public document ASTM D4444, section 6.

7.7 MR12 Ball Moisture Probe (Optional)

The MR12 allows you to take pinless moisture measurements with all the benefits of a remote probe, i.e. easier access to surfaces and manoeuvrability.

1. Connect the MR12 to the RJ jack at the bottom of the meter.
2. Select the MR12 probe option in the menu (*Moisture Mode/MR12*); see **Figure 7-12** above.
3. Touch the MR12 probe to the surface under test.
4. View the moisture reading on the MR277 in either the Moisture-only display mode or the Thermal/Visible camera modes. Use the menus to select the display modes (*Image Modes*).
5. Pinless measurement readings are 'relative' scaled (0~100).

7.8 Set Reference Mode

1. Select the 'Set Reference' mode from the menu (*Moisture mode/Set Reference* ); see **Figure 7-13** above. This mode is only available for pinless measurements, including the optional MR12 Ball Moisture probe.
2. When the 'Set Reference' mode is selected, the displays are affected in the following ways:
 - Thermal/Visible Camera modes: A delta (triangle) symbol is shown after the moisture reading indicating that the reading represents the current measurement minus the reference value (the measurement recorded at moment the 'Set Reference' mode was selected).
 - Moisture-only mode: The reference value, with delta symbol, is shown on the right side of the display and the moisture reading (offset by the reference value) is shown on the left in large digits.
1. All measurements taken subsequently will be relative to the reference value. For example, if the reference value is '20' (representing the driest area of the material under test) and a measurement of '25' is taken (in an area with higher moisture content), the measurement will show '5' ($25 - 20 = 5$). As implied, this mode is useful for comparing wet areas to a dry area reference.
2. To remove the reference value and exit the mode: Remove the meter sensor from the area under test, so that the sensor is no longer touching a surface and is clear of any objects, and then select the pin-mode from the *Moisture Mode* menu.

7.9 High Moisture Alarm

1. To access the Alarm mode use the menus (*Settings/Radiometry & Moisture Alarm mode*). See Section 8.4 for High/Low Radiometry (Temperature) Alarm mode.

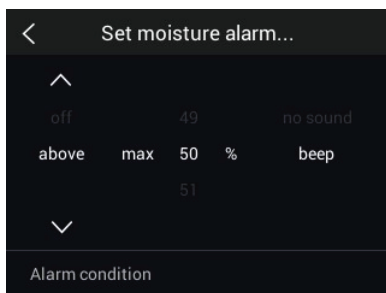



Figure 7.14 Setting the Moisture Alarm

2. Select the 'Set Moisture Alarm' mode.
3. Use the navigation arrows and *Select* button  to set the Alarm to 'ABOVE' or 'OFF', to set the max. threshold (0% to 100%), and to select 'No Sound' or 'Beep' for the alarm alert; the visual alert is always active. Press *Select* to confirm and press *Return*  to exit the menu.
4. When the High Alarm is enabled, the main display will show the alarm bell icon next to the measurement digits. Refer to **Section 5.8 Settings menu** for additional information.
5. When the measurement exceeds the threshold, the text for the measurement reading will appear red in color. Note that in the Moisture-only mode, the larger digits appear in red when the alarm limit is exceeded. See **Figure 7–15** below.

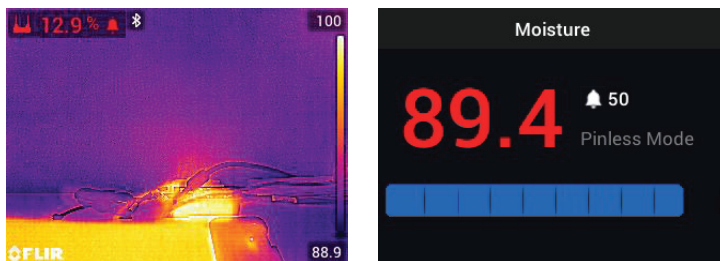



Figure 7.15 Moisture Alarm display examples

6. If the beeper is enabled in step 3 above, the beeper will sound when the moisture exceeds the threshold. To silence the beeper when the meter is alarming, press *Select* . The meter will open the 'Settings' menu where you can opt to turn the beeper OFF or otherwise program the alarm parameters.

8 Thermal and Visible Camera Operation

8.1 Thermal Camera

The full screen Thermal Camera is active in the Thermal mode and the Thermal MSX® mode (digital camera image superimposed on thermal image). Select the image type in the menu: *Select* button/*Image Mode* as described in **Section 5.4 Image Mode Menu**.

The Thermal Camera lens is located on the back of the meter. Face the lens toward the area of interest and view the image on the MR277 display.

Select the thermal image color palette from the menu ( *Color*). Choose Iron, Rainbow, White hot, Black hot, or Arctic.

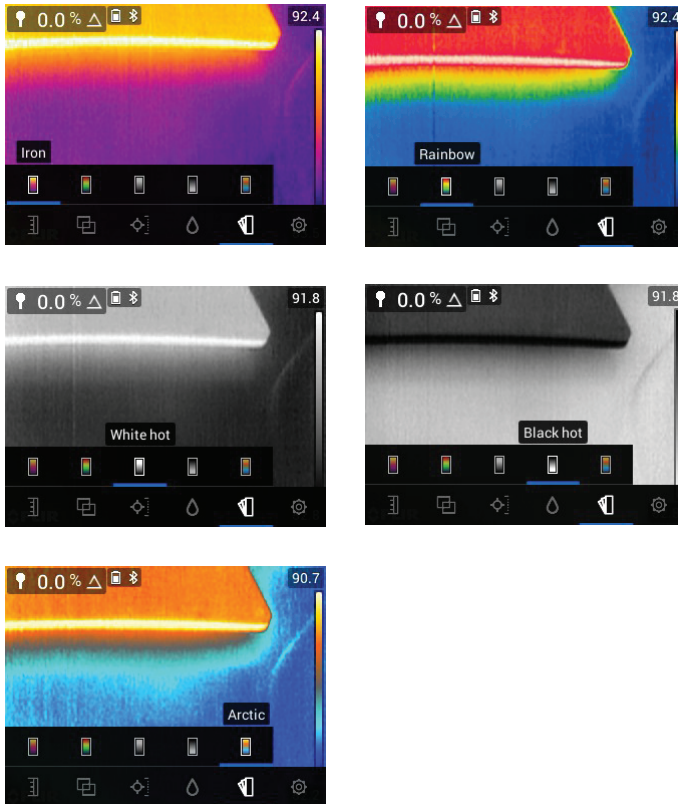

Figure 8.1 Color Palette options

On the right side of the thermal images, a vertical bar graph provides a temperature scale for convenience. The top of the scale shows the hotter pixels in the frame, and the lower part of the scale shows the colder pixels. Digital readouts appear on the top and bottom of the bar graph to show the high and low range limits for the camera image. See **Figure 8.1**.

When the Laser pointer button \triangle is pressed, the Laser beam appears. Use the Laser beam and display cross-hairs to target the surfaces under test.

Note that the Laser is carefully aimed to align with the cross-hairs for easier identification and targeting of objects and surfaces.

Cross-hairs are visible when 'Center Spot' is selected from the 'Measurement' menu (*Measurement mode*). Cross-hairs are also visible in the 'Custom IGM™ mode' when 'Radiometry' is selected in the 'Custom IGM™' menu in the 'Settings' menu (*Settings/Custom IGM™*).

8.2 Automatic/Lock Temperature Scaling

Note: For best results, allow a warm-up period of 3-5 minutes before using this feature.

The Auto/Lock Scale option allows the color palette range to be adjusted to suit a given application. For example, when viewing both cold and hot objects in the same frame, the auto-scaling (default mode) will cause the palette to 'stretch', as to fit the whole range of temperatures. However, this can cause smaller temperature variations to go undetected, as the difference between two colors might increase from 1° to 10°. In this case, the user may choose to lock the scale with only the cold or medium-temperature objects in the frame. This would cause the hot objects to saturate, but will provide more detail to the colder objects of interest.

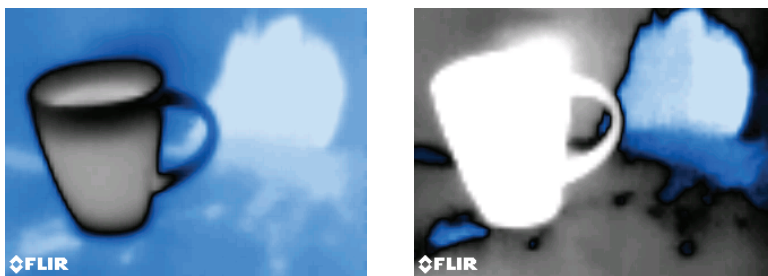





Figure 8.2 Figure on left is 'auto-scaled' while the figure on right is 'scale locked'

If you wish to narrow the range of color and limit it to colors near the cold temperature image, set the scale mode to 'Lock' with no hot objects in the frame. To lock the scale, press *Select*  to access the Main Menu, scroll to the Temperature Scale mode , press *Select*, and scroll to the 'Lock' mode ; press *Select* to confirm and to exit the menu. Some experimentation and fine-tuning may be required to obtain the best possible contrast.

For additional programming details see **Section 5.3** *Temperature Scale menu*.

8.3 Digital (Visible) Camera

Select the full screen Digital Camera from the menu system: *Select* button/Image Mode/Digital Camera .

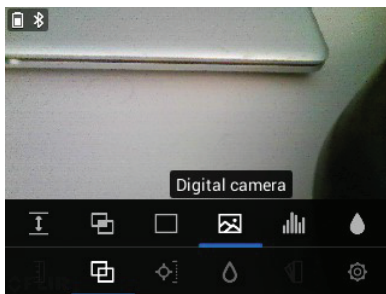



Figure 8.3 Selecting the Digital Camera image

The Digital Camera lens is located on the back of the meter. Face the lens toward the area of interest and view the image on the display.



Measurement data can be superimposed on the Digital Camera image. From the menu system use the Custom IGM™ menu to select the measurements you wish to see on the camera image (*Settings/Custom IGM™*). Select the IGM™ Custom option from the Measurement menu (*Measurement/IGM™ Custom mode*) in order to see all of the parameters, selected in the Settings menu, superimposed on the camera image.

When the Laser pointer button  is pressed, the Laser beam appears. Use the Laser beam and the cross-hairs ('Center Spot' selection in the *Measurement* menu) to target the surfaces under test. The temperature reading represents the spot targeted by the cross-hairs and Laser pointer.

Note that the Laser is carefully aimed to align with the cross-hairs for easier identification and targeting of objects and surfaces.

8.4 High/Low Radiometry (Temperature) Alarms

1. To access the Alarm mode use the menu (*Settings/Radiometry & Moisture Alarm mode*).
2. Select the 'Radiometry Alarm' mode.

3. Use the navigation arrows and *Select* button  to set the Alarm (ABOVE, BELOW, or OFF) and to set the temperature limit. There is no beeper available for the Radiometry alarms so the 'No Sound' setting cannot be changed. Press *Select* to confirm and press *Return*  to exit the menu.
4. When the High or the Low Alarm is enabled, the main display will show the alarm bell icon next to the measurement digits as shown in **Figure 8-4** below.
5. When the measurement exceeds the high threshold (i.e., when ABOVE setting is chosen), the text for the measurement reading will appear red in color. When the measurement falls below the low threshold (when BELOW setting is chosen), the text for the measurement reading will appear blue in color.

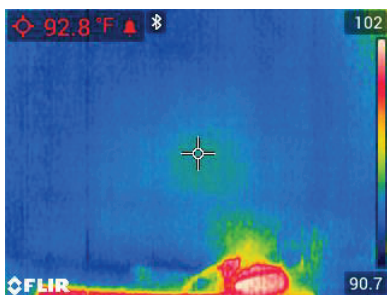

Figure 8.4 High Radiometry alarm example. Note that the reading is red in color

9 Ambient Temperature and Humidity Measurements



9.1 Temperature & RH Measurements and Dew Point, Vapor Pressure, and Mixing Ratio Calculations

The removable MR13 connects to the top of the MR277 and senses ambient Temperature and Relative Humidity. Calculations based on these Temperature and Relative Humidity measurements are also provided. These calculations are Dew Point Temperature, Vapor Pressure (in units of kilo-Pascals), and Mixing ratio (in Grains Per Pound).

Dew Point is the temperature at which moisture begins to condense on a surface.

Vapor Pressure is a measurement of the amount of water vapor in a volume of air. The reading increases as the amount of water vapor increases.

Mixing ratio is the amount of water vapor in air.

To view these ambient measurement readings and calculations, first select the IGM™ Custom display mode from the menu (*Measurement*). Next, select the desired parameters in the 'Settings' menu (*Settings/IGM™ Custom mode*). In the IGM™ Custom menu you can press *Select*  at each of the desired parameters. Press *Return*  to exit to the normal operating mode.

The Image modes that can display ambient measurements are: Thermal MSX®, Thermal, Digital Camera, and Psychrometrics. Use the menu to select an Image mode (*Image mode*).

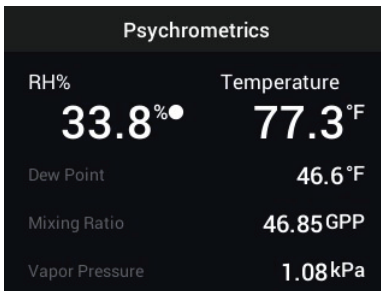

Figure 9.1 Psychrometrics screen example showing Relative Humidity & Temperature measurements measured by the MR13 sensor. The MR277 then calculates Dew Point temperature, Vapor pressure, and Mixing ratio based on the Temperature and RH measurements

9.2 Progressive Environmental Stability Indicator for RH%

The Progressive Environmental Stability Indicator is useful for determining when relative humidity readings on the MR277 have stabilized (for example, when taking ambient readings in an air duct).

The circle next to the RH% display line fills and turns green when the relative humidity reading stabilizes. The circular indicator is hollow when the reading has not stabilized and fills in grey as stability is approached, finally filling in completely and turning green when fully stabilized. Note that the RH% reading digits also turn green when the reading has stabilized.

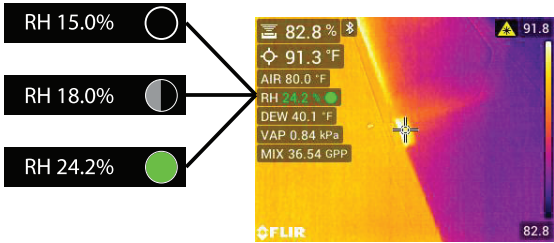





Figure 9.2 RH stability progression. In the example you can see how the circle fills as stability is approached and finally reached.

Note that for areas where environmental conditions change frequently, the indicator may not entirely fill and turn green, this is normal. The indicator is available in the IGM™ Custom, IGM™ Moisture, and Psychrometric modes. Use the menu to access these modes (*Measurement*) to locate the IGM™

modes:   and *Image Mode* to locate the Psychrometrics mode .

10 Capturing and Working with Screen Captures

10.1 Capturing Images





To capture a screen image, press the Camera button (shown above). The display will briefly show the filename assigned to the captured image at the top of the screen. Screen images can be captured for any Image mode: Thermal MSX®, Thermal, Digital Camera, Psychrometrics, and Moisture mode. If the internal memory is full, an error will display and images cannot be captured until room is made available in the internal storage drive. Images cannot be captured if the MR277 is connected to device via USB.

10.2 Viewing Images on the MR277



Press the Image Gallery button (shown above) to open the Image Gallery. Use the navigation arrow buttons to scroll through the thumbnails and press *Select*  to open and enlarge an image. Press *Select* at an opened image to view the filename, and press again to see image options (delete, transmit) as explained below.

10.3 Deleting images

At an opened image, press *Select*  twice to see the transmit and delete icons. Scroll to the 'delete' icon (trash can) and press *Select*  to erase the image. Images can also be deleted in bulk by formatting the storage memory in the Settings menu (*Settings/Format Options*). Images can also be deleted or moved by connecting the MR277 to a PC, see the next section.





10.4 Transferring Images via PC Interface

Connect the MR277 to a Windows™ or Apple™ computer's USB port using the supplied USB cable. The USB jack is located on the bottom of the MR277, under the protective flap. Once connected, the MR277 can be used as you would any external storage drive. Note that on Apple™ computers, the 'Photos' App is not compatible with the MR277 and will generate an error message (*No Photos*) when opened. However the MR277 images are recognized in the computer's Finder window.

Note: Device is not 100% compatible with Mac OS, please do not format MR277 internal memory via Mac OS.

10.5 Transmitting Images and Data via Bluetooth®

The MR277 images and reading data can be transmitted to a mobile device running the FLIR Tools™ App. In addition, MR277 readings can be viewed on certain FLIR cameras.

Press the Image Gallery button  to open the Image Gallery. Use the navigation arrow buttons to scroll through the thumbnails and press *Select*  to open an image. Press *Select*  twice more to see the Delete (trash can) and Transmit icons. Scroll to the transmit icon and press *Select*  to transmit an image to a paired mobile device. For additional information, please refer to Section 11, *Bluetooth® Communication and FLIR Tools™*.

11 Bluetooth® Communication and FLIR Tools™

To connect the MR277 to a mobile device running the FLIR Tools™ Mobile App, turn on the mobile device and start the FLIR Tools™ Mobile App (download the mobile App from the Google Play™ store, the Apple App store, or here: <https://www.flir.com/products/flir-tools-app/>).

Select INSTRUMENTS from the drop-down menu in the App and search for the MR277 (the MR277 must be ON). Tap in the App to connect to the MR277.

When connected to a device running the App, the MR277 (using the METER-LiNK® protocol) continually sends readings for live display on the remote device. You can also send captured images on the MR277 to your mobile device (see Section 10 *Capturing and Working with Images*).

11.1 FCC Compliance

This device complies with part 15 of the FCC Rules. Operation is subject to the following two conditions:

1. This device may not cause harmful interference.
2. This device must accept any interference received, including interference that may cause undesired operation.

This equipment has been tested and found to comply with the limits for a Class B digital device, pursuant to part 15 of the FCC Rules. These limits are designed to provide reasonable protection against harmful interference in a residential installation. This equipment generates, uses, and can radiate radio frequency energy and, if not installed and used in accordance with the instructions, may cause harmful interference to radio communications. However, there is no guarantee that interference will not occur in a particular installation. If this equipment does cause harmful interference to radio or television reception, which can be determined by turning the equipment off and on, the user is encouraged to try to correct the interference by one or more of the following measures:

1. Reorient or relocate the receiving antenna.
2. Increase the separation between the equipment and receiver.
3. Connect the equipment into an outlet on a circuit different from that to which the receiver is connected.

4. Consult the dealer or an experienced radio/TV technician for help.

**WARNING**

Changes or modifications not expressly approved by the party responsible for compliance could void the user's authority to operate the equipment.

12 Field Firmware Updates

The MR277 includes a USB port under the bottom flap. The USB port allows the user to update the System firmware by first downloading an update file from the FLIR website and then transferring the file to the MR277. Connect the MR277 to a PC using the supplied USB cable. Firmware updates are available from <https://support.flir.com>.

To update the firmware, you will need:

- Access to the website where the update file is located:
<https://support.flir.com>
- The MR277 to be updated
- The update file. Refer to the steps in the next sections.

12.1 System Firmware Update

1. Visit <https://support.flir.com> to obtain a firmware update file.
2. Select the 'Downloads' tab and then select 'Instrument Firmware' (Test and Measurement) from the drop-down menu.
3. Select the MR277 from the second drop-down menu.
4. Select and download the firmware update file to the PC.
5. With the MR277 **ON** connect it to the PC via the supplied USB cable.
6. Copy the firmware update file to the MR277 root directory.
7. Eject the MR277 from the PC.
8. Disconnect the USB cable from the PC USB port and from the MR277 USB port.
9. Follow the MR277 display prompts to complete the update.

13 Maintenance

13.1 Cleaning

Wipe the housing with a damp cloth as needed. Do not use abrasives or solvents. Clean the lenses with a high-quality lens cleaner.

13.2 Battery Service

The rechargeable lithium battery is not user-serviceable. Please contact FLIR support for service instructions: <https://support.flir.com>.

If the MR277 is not going to be used for > 3 months, it should be charged to at least 70% then stored at room temperature and recharged every 6 months. Failure to do so may result in a battery that cannot be recharged and must be serviced.

13.3 Disposal of Electronic Waste



As with most electronic products, this equipment must be disposed of in an environmentally friendly way, and in accordance with existing regulations for electronic waste. Please contact your FLIR Systems representative for more details.

13.4 MR277 Crash Recovery

If the MR277 display freezes or if the MR277 in any way ceases operating normally, press and hold the up and down navigation arrow buttons for at least 10 seconds. Release the buttons when the start-up screens appear, and allow the device to reboot. No data will be lost by running this procedure. If problems persist, contact FLIR for further assistance.

14 Specifications

14.1 General Specifications

Display	QVGA (320 x 240 pixel) 2.3" 64K color TFT graphical display
Internal memory	8GB storage for captured images
Stored image format	.jpg with measurement readings superimposed
Power supply	3.7V, 5400mAh Li-Po battery; rechargeable via USB
Battery life	8-hour continuous run-time, maximum. When stored for > 3 months, charge battery to 70% and recharge every 6 months.
Auto Power OFF	Programmable: OFF, 5, 10, 20, and 30 minutes
Low battery indicator	Battery icon and text % is displayed when the Main Menu is accessed. When charging, the battery status icon is displayed in the normal operating mode
Operating temperature	32 ~ 122°F (0 ~ 50°C)
Storage temperature	14 ~ 140°F (-10 ~ 60°C)
Operating humidity	≤ 90%, 32 ~ 86°F (0 ~ 30°C)
	≤ 75%, 86 ~ 104°F (30 ~ 40°C)
	≤ 45%, 104 ~ 122°F (40 ~ 50°C)
Storage humidity	90% RH
Dimensions (H x W x D)	6.9 x 3.5 x 1.7" (17.5 x 9.0 x 4.2 cm)
Product Weight	14.1 oz. (400 g)
Included accessories	MR13 replaceable Temperature and RH Sensor, MR02 Standard Pin Probe, Quick Start Guide, and USB cable
Language options	Multi-language support for programming menus

14.2 Imaging Specifications

Thermal imaging camera	FLIR Lepton®, microbolometer FPA (focal plane array)
Image calibration	Automatic (with lock-scale option: see Temperature Scale option from the Main Menu)

Thermal image resolution	160(W) x 120(H) pixels
Spectral response	8~14 μ m
Field of view	71° horizontal x 51° vertical
Thermal Sensitivity	< 150mK
Detection Limit	Wet area detection @ 32' (10m): 19.7in ² (49cm ²)
Thermal frame update rate	9 Hz
Thermal image palettes	Selectable: Iron, Rainbow, White hot, Black hot, and Arctic
Minimum focus distance	4" (10 cm)
Laser pointer	Visible light Class II, centered on thermal image; 1.0 mW (max. power) Wavelength: 650 \pm 20nm

14.3 Moisture Meter Specifications

Internal Pinless Sensor Measurements	0 to 100 (relative readings)
External Pin-based Measurements	7% - 30%; ¹ Accuracy for 7% ~ 30% range: (\pm 1.5% MC); ² 30%-100% (Reference Only) ³
Measurement Resolution	0.1
Pinless Measurement Depth	0.75" (1.9 cm) maximum
Pin Moisture Groups	Eleven (11) material groups
Response time	Pinless mode: 100ms, Pin mode: 750ms

1. Maximum specified range is dependent on the fiber saturation point for specific species. Beyond this point, the reading can only be used as a relative reference value. For more information on fiber saturation please refer to public document ASTM D7438. Accuracy specification is based on the analysis in J. Fernández-Golfín et al. Actual real-world accuracy depends on a variety of factors; For more information, refer to public document ASTM D4444, section 6.
2. Accuracy spec. applies to pin probe moisture measurements taken on wood whose temperature is 70°F (20°C). Add 0.1% to the accuracy spec. for each °C below 20 or subtract 0.1 for each °C above 20.
3. See Note 1.

14.4 Visible Spectrum Camera Specifications

Camera resolution	2M pixels
Focus	Fixed
Field of view	83°

14.5 Safety Specifications

General Safety	CE/EN/UL/CSA/PSE 61010
Environmental Safety	REACH Regulation EC 1907/2006 RoHS2 Directive 2011/65/EC WEEE Directive 2012/19/EC JIS C 6802:2011 laser directive IEC 60825-1 class II laser directive FDA Laser directive
Encapsulation	IP54 (IEC 60529) with bottom flap fully sealed
Drop-proof	Designed to 6.6 ft. (2 m)
EMC	EN 61000-6-3 EN 61000-6-2 FCC 47 CFR Part 15 Class B

14.6 MR13 Sensor Measurement and Calculation Specifications

Parameter	Range	Accuracy	Resolution
Relative Humidity	10-90%	±2.5%	0.1
Air Temperature	32 to 122°F (0 to 50°C)	±1.1°F (±0.6°C)	
Dew Point	-22 to 122°F (-30 to 50°C)	n/a (calculation)	
Vapor Pressure	0.0–12.0 kPa	n/a (calculation)	
Mixing Ratio	0-560 GPP (0.0-80.0 g/kg)	n/a (calculation)	



NOTE

Relative Humidity Sensor Note:

The meter should be stored in an environment with a relative humidity similar to the area to be tested. If the storage humidity differs by more than 50% RH from the area under test, an acclimation period of up to 24 hours may be required to meet the specified RH accuracy.

15 Appendices

15.1 Material Groups

15.1.1 Common names of timbers

(BS888/589:1973) with MR277 Group Numbers

	NOTE
<p>Use Group 9 for building materials: plywood, drywall, and oriented strand board (OSB). Use Group 10 for brick, cement screed, and concrete. Use Group 11 for cement mortar, anhydrite screed, lime mortar, and plaster. Groups 10 and 11 are not specified for accuracy and should be used for reference (comparative purposes) only.</p>	

Material	Group	Material	Group	Material	Group
Abura	4	Gurjun	1	Pine, American Long Leaf	3
Afara	1	Hemlock, Western	3	Pine, American Pitch	3
Aformosa	6	Hiba	8	Pine, Bunya	2
Afzelia	4	Hickory	5	Pine, Caribbean Pitch	3
Agba	8	Hyedunani	2	Pine, Corsican	3
Amboyna	6	Iroko	5	Pine, Hoop	3
Ash, American	2	Ironbank	2	Pine, Huon	2
Ash, European	1	Jarrah	3	Pine, Japanese Black	2
Ash, Japanese	1	Jelutong	3	Pine, Kauri	4
Ayan	3	Kapur	1	Pine, Lodgepole	1
Baguacu, Brazilian	5	Karri	1	Pine, Maritime	2
Balsa	1	Kauri, New Zealand	4	Pine, New Zealand White	2
Banga Wangra	1	Kauri, Queensland	8	Pine, Nicaraguan Pitch	3
Basswood	6	Keruing	5	Pine, Parana	2

Beech, European	3	Kuroka	1	Pine, Ponderosa	3
Berlina	2	Larch, European	3	Pine, Radiata	3
Binvang	4	Larch, Japanese	3	Pine, Red	2
Birch, European	8	Larch, Western	5	Pine, Scots	1
Birch, Yellow	1	Lime	4	Pine, Sugar	3
Bisselon	4	Loliondo	3	Pine, Yellow	1
Bitterwood	5	Mahogany, African	8	Poplar, Black	1
Blackbutt	3	Mahogany, West Indian	2	Pterygota, African	1
Bosquiea	1	Makore	2	Pyinkado	4
Boxwood, Maracaibo	1	Mansonia	2	Queensland Kauri	8
Camphorwood, E African	3	Maple, Pacific	1	Queensland Walnut	3
Canarium, African	2	Maple, Queensland	2	Ramin	6
Cedar, Japanese	2	Maple, Rock	1	Redwood, Baltic (European)	1
Cedar, West Indian	8	Maple, Sugar	1	Redwood, Californian	2
Cedar, Western Red	3	Matai	4	Rosewood, Indian	1
Cherry, European	8	Meranti, Red (dark/light)	2	Rubberwood	7
Chestnut	3	Meranti, White	2	Santa Maria	7
Coachwood	6	Merbau	2	Sapele	3
Cordia, American Light	5	Missanda	3	Sen	1
Cypress, E African	1	Muhuhi	8	Seraya, Red	3

Cypress, Japanese (18-28% mc)	3	Muninga	6	Silky Oak, African	3
Cypress, Japanese (8-18%mc)	8	Musine	8	Silky Oak, Australian	3
Dahoma	1	Musizi	8	Spruce, Japanese (18-28% mc)	3
Danta	3	Myrtle, Tasmanian	1	Spruce, Japanese (8-18% mc)	8
Douglas Fir	2	Naingon	3	Spruce, Norway (European)	3
Elm, English	4	Oak, American Red	1	Spruce, Sitka	3
Elm, Japanese Grey Bark	2	Oak, American White	1	Sterculia, Brown	1
Elm, Rock	4	Oak, European	1	Stringybark, Messmate	3
Elm, White	4	Oak, Japanese	1	Stringybark, Yellow	3
Empress Tree	8	Oak, Tasmanian	3	Sycamore	5
Erimado	5	Oak, Turkey	4	Tallowwood	1
Fir, Douglas	2	Obeche	6	Teak	5
Fir, Grand	1	Odoko	4	Totara	4
Fir, Noble	8	Okwen	2	Turpentine	3
Gegu, Nohor	7	Olive, E African	2	Utile	8
Greenheart	3	Olivillo	6	Walnut, African	8
Guarea, Black	8	Opepe	7	Walnut, American	1
Guarea, White	7	Padang	1	Walnut, European	3
Gum, American Red	1	Padauk, African	5	Walnut, New Guinea	2

Gum, Saligna	2	Panga Panga	1	Walnut, Queensland	3
Gum, Southern	2	Persimmon	6	Wandoo	8
Gum, Spotted	1	Pillarwood	5	Wawa	6
				Whitewood	3
				Yew	3

15.1.2 Botanical names of timbers

Material	Group	Material	Group	Material	Group
Abies alba	1	Eucalyptus acmenicides	3	Picea jezoensis (8-18%mc)	8
Abies grandis	1	Eucalyptus crebra	2	Picea sitchensis	3
Abies procera	8	Eucalyptus diversicolor	1	Pinus caribaea	3
Acanthopanax ricinifolius	1	Eucalyptus globulus	2	Pinus contorta	1
Acer macrophyllum	1	Eucalyptus maculate	1	Pinus lampertiana	3
Acer pseudoplatanus	5	Eucalyptus marginata	3	Pinus nigra	3
Acer saccharum	1	Eucalyptus microcorys	1	Pinus palustris	3
Aetoxicon punctatum	6	Eucalyptus obliqua	3	Pinus pinaster	2
Aformosia elata	6	Eucalyptus pilularis	3	Pinus ponderosa	3
Afzelia spp	4	Eucalyptus saligna	2	Pinus radiata	3
Agathis australis	4	Eucalyptus wandoo	8	Pinus spp	2
Agathis palmerstoni	8	Fagus sylvatica	3	Pinus strobus	1
Agathis robusta	8	Flindersia brayleyana	2	Pinus sylvestris	1

Amblygonocarpus andogensis	1	Fraxinus Americana	2	Pinus thunbergii	2
Amblygonocarpus obtusungulis	1	Fraxinus excelsior	1	Pipadeniastrum africanum	1
Araucaria angustifolia	2	Fraxinus japonicus	1	Piptadenia africana	1
Araucaria bidwilli	2	Fraxinus mardshurica	1	Podocarpus dactyloides	2
Araucaria cunninghamii	3	Gonystylus macrophyllum	6	Podocarpus spicatus	3
Berlinia grandiflora	2	Gossweilodendron balsamiferum	8	Podocarpus totara	4
Berlinia spp	2	Gossypiospermum proerox	1	Populus spp	1
Betula alba	8	Grevillea robusta	3	Prunus avium	8
Betula alleghaniensis	8	Guarea cedrata	7	Pseudotsuga menzesii	2
Betula pendula	8	Guarea thomsonii	8	Pterocarpus angolensis	6
Betula spp	8	Guibortia ehie	2	Pterocarpus indicus	6
Bosquiera phoberos	1	Hevea brasiliensis	7	Pterocarpus soyauxii	5
Brachylaena hutchinsii	8	Intsia bijuga	2	Pterygota bequaertii	1
Brachystegia spp	2	Juglans nigra	1	Quercus cerris	4
Calophyllum brasiliense	7	Juglans regia	3	Quercus delegatensis	3
Canarium schweinfurthii	2	Khaya ivorensis	8	Quercus gigantean	3
Cardwellia sublimes	3	Khaya senegalensis	4	Quercus robur	1
Carya glabra	5	Larix decidua	3	Quercus spp	1

Cassipourea elliotii	5	Larix kaempferi	3	Ricinodendron heudelotti	5
Cassipourea melanosana	5	Larix leptolepis	3	Sarcocephalus diderrichii	7
Castanea sutiva	3	Larix occidentalis	5	Scottellia coriacea	4
Cedrela odorata	8	Liquidambar styraciflua	1	Sequoia sempervirens	2
Ceratopetalum apetalum	6	Lovoa klaineana	8	Shorea spp	2
Chamaecyparis spp (18-28%mc)	3	Lovoa trichiloides	8	Sterculia rhinopetala	1
Chamaecyparis spp (8-18%mc)	8	Maesopsis eminii	8	Swietenia candollei	1
Chlorophora excelsa	5	Mansonia altissima	2	Swietenia mahogani	2
Cordia alliodora	5	Millettia stuhimannii	1	Syncarpia glomulifera	3
Croton megalocarpus	8	Mimusops heckelii	2	Syncarpia laurifolia	3
Cryptomelia japonica	2	Mitragyna ciliata	4	Tarrietia utilis	3
Cupressus spp	1	Nauclea diderrichii	7	Taxus baccata	3
Dacrydium franklinii	2	Nesogordonia papaverifera	3	Tectona grandis	5
Dalbergia latifolia	1	Nothofagus cunninghamii	1	Terminalia superba	1
Diospyros virginiana	6	Ochroma pyramidalis	1	Thuja plicata	3
Dipterocarpus (Keruing)	5	Ocotea rodiaei	3	Thujopsis dolabrata	8
Dipterocarpus zeylanicus	1	Ocotea usambarensis	3	Tieghamella heckelii	2
Distemonanthus benthamianus	3	Octomeles sumatrana	4	Tilia americana	6

Dracontomelum mangiferum	2	Olea hochstetteri	2	Tilia vulgaris	4
Dryobalanops spp	1	Olea welwitschii	3	Triploehiton scleroxylon	6
Dyera costulata	3	Palaquium spp	1	Tsuga heterophylla	3
Endiandra palmerstoni	3	Paulownia tomentosa	8	Ulmus americana	4
Entandrophragma angolense	7	Pericopsis elata	6	Ulmus procera	4
Entandrophragma cylindricum	3	Picaenia excelsa	3	Ulmus thomasi	4
Entandrophragma utile	8	Picea abies	3	Xylia dolabriformis	4
Erythrophleum spp	3	Picea jezoensis (18-28%mc)	3	Zelkova serrata	2

15.2 %WME Table (% Wood Moisture Equivalent)

Material Wood Group Nos.								
1	2	3	4	5	6	7	8	9
%WME (percent wood moisture equivalent)								
7	8.2	9	8	7.1	7	11	10.5	-
8	10	10.5	9.3	7.5	7.4	11.5	11	-
9	10.8	10.9	9.7	7.9	8.1	12.1	11.6	8.5
10	11.7	11.5	10.4	8.6	8.8	12.7	12.2	9.4
11	12.7	12.6	11.3	9.5	9.7	13.4	13.4	10.5
12	13.6	13.7	12.1	10.5	10.5	14	14.3	11.5
13	14.5	14.5	12.7	11.2	11.2	14.5	15.1	12.5
14	15.3	15.5	13.4	11.8	11.8	15	16	13.5
15	16.3	16.7	14.1	12.5	12.6	15.6	17	14.4
16	16.9	17.5	14.8	13	13.2	16	17.7	14.9
17	17.7	18.8	15.7	14.3	13.9	16.6	18.5	15.3
18	18.2	19.7	16.3	15	14.5	17	19.1	16.1
19	19	21	16.9	15.9	15.2	17.6	20	16.7
20	20	22.6	17.8	16.9	16.1	18.4	21.3	17.2

21	20.8	23.5	18.5	17.6	16.8	19.1	22.3	18.3
22	21.5	24.5	19.3	18.3	17.4	19.7	23.2	19.1
23	22.9	26.4	20.2	19.8	18.6	21.2	25.3	19.9
24	23.5	27.4	20.8	20.4	19	22	25.8	20.5
25	24.2	27.8	21.2	21	19.4	22.7	26.3	≈23
26	25.3	29	22.4	22.3	20.1	23.9	27.3	-
27	26.5	-	23.3	23.4	20.8	24.7	28.1	-
28	28	-	24.4	24.8	21.7	25.9	-	-
29	29.6	-	25.6	26.3	22.9	27.1	-	-

16 Limited 10–Year Warranty

This product is protected by FLIR's Limited 10-Year Warranty. Visit <https://support.flir.com/prodreg> to read the Limited 10-Year Warranty document.

17 Customer Support

Repair, Calibration, and Technical Support: <https://support.flir.com>.

17.1 Corporate Headquarters

FLIR Systems, Inc.

27700 SW Parkway Avenue

Wilsonville, OR 97070 USA



Website

<http://www.flir.com>

Customer support

<http://support.flir.com>

Copyright

© 2019, FLIR Systems, Inc. All rights reserved worldwide.

Disclaimer

Specifications subject to change without further notice. Models and accessories subject to regional market considerations. License procedures may apply. Products described herein may be subject to US Export Regulations. Please refer to exportquestions@flir.com with any questions.

Publ. No.: NAS100005
Release: AG
Commit: 62027
Head: 62027
Language: en-US
Modified: 2019-12-18
Formatted: 2019-12-18