

EXTECH[®]

USER MANUAL

Thermal Imager IR Thermometer

MODEL IRC130

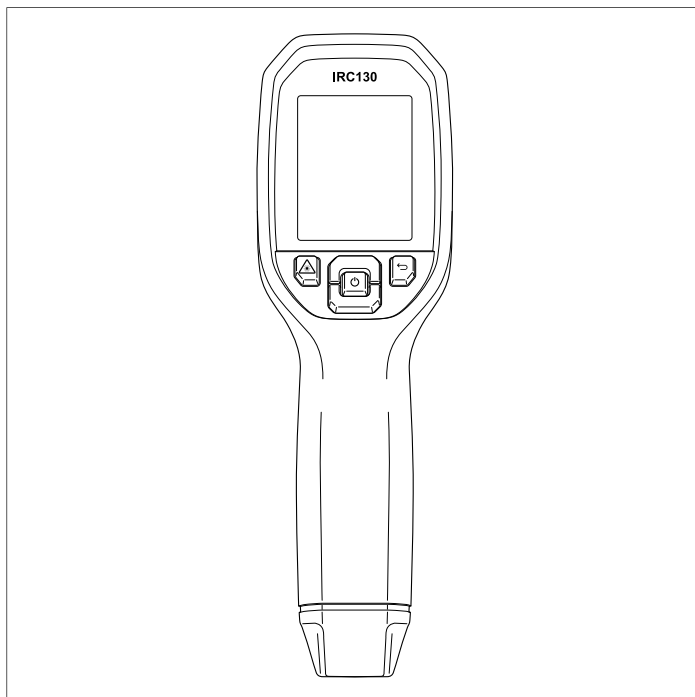

Table of contents

1	Introduction.....	1
2	Safety	2
2.1	Safety Warnings and Cautions.....	2
3	Description.....	3
3.1	Product Description.....	3
3.2	Control Button Descriptions	4
3.3	Display Description	4
4	Operation	6
4.1	Powering the IRC130.....	6
4.2	IR Camera and Thermometer	6
4.3	High Temperature Switch	7
4.4	Visible Spectrum Camera	8
4.5	Capture, View, Transfer, Send, and Delete Camera Images	8
5	Programming Menu System	9
5.1	Menu System Basics	9
5.2	Main Menu	9
5.3	SETTINGS Sub-Menu	11
6	Field Firmware Updates	16
6.1	System Firmware Update	16
7	Maintenance.....	17
7.1	Cleaning.....	17
7.2	Battery Considerations and Service	17
7.3	Disposal of Electronic Waste	17
7.4	Reset the IRC130	17
8	Specifications.....	18
8.1	Imaging and Optical Specifications	18
8.2	Detector Specifications	18
8.3	Image Presentation Specifications.....	18
8.4	Measurement Specifications	19
8.5	Measurement Analysis Specifications	19
8.6	Configuration Specifications.....	19
8.7	Image Storage Specifications	20
8.8	Digital Camera	20
8.9	Flashlight Specifications.....	20
8.10	Laser Pointer Specifications.....	20

Table of contents

8.11	Data Interface Specifications	21
8.12	Rechargeable Battery Specifications	21
8.13	Environmental Specifications	21
8.14	Physical Specifications	22
8.15	Included Equipment	22
9	Warranty and Customer Support	23
9.1	Two-Year Warranty	23
9.2	Repair and Calibration Services	23
9.3	Customer Support	23

1 Introduction







The Extech IRC130 Thermal Imager IR Thermometer combines non-contact temperature measurement and thermal imaging into one troubleshooting tool to help you quickly find the source of heat-related problems and to spot potential faults when performing maintenance and repair.

Features

- 80 x 60 pixel true thermal imager (Lepton® microbolometer with integrated shutter)
- Visible spectrum 2M pixel digital camera
- Adjustable MSX® (Multi-Spectral Dynamic Imaging) adds key details from the visible spectrum to the IR image for improved diagnostics
- Easy-to-read 320 x 240 2.4" TFT color LCD display
- Wide temperature range -4 ~ 1202°F (-20 ~ 650°C)
- High temperature switch for measurements > 752°F (400°C)
- Intuitive programming menu system in over 21 languages
- 3 presets and 1 custom emissivity setting
- LED Flashlight
- Laser pointer and cross-hair display for easy targeting
- 4 GB internal image capture memory
- USB-C connectivity for image transfer and charging
- IP54 enclosure protects from dirt, dust, and oil
- Rechargeable battery with adjustable auto power off (APO) timer
- Accessory mounting for tripods and other accessories

2 Safety

2.1 Safety Warnings and Cautions

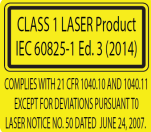
	WARNING
<p>⚠ This symbol, adjacent to another symbol indicates the user must refer to the manual for further information.</p>	
	WARNING
<p>The instrument's IP54 rating is only in affect when the top flap (covering the USB-C jack) is completely sealed. Do not operate the instrument with the flap open, except for charging and PC interface.</p>	
	CAUTION
<p>Use of controls or adjustments or performance of procedures other than those specified herein may result in hazardous radiation exposure.</p>	
	CAUTION
<p>Use extreme caution when the Laser pointer is on.</p>	
	CAUTION
<p>Do not point the Laser beam toward anyone's eye or allow the beam to strike the eye from a reflective surface.</p>	
	CAUTION
<p>Do not use the Laser near explosive gases or in other potentially explosive areas.</p>	
	CAUTION
<p>Refer to the CAUTION statement label (shown below) for critical safety information.</p>	
	

3 Description

3.1 Product Description

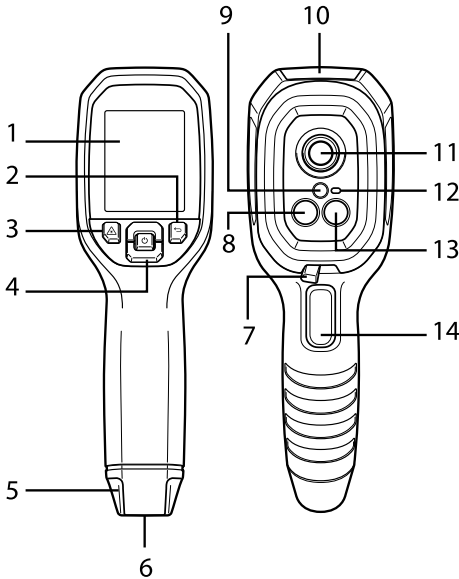







Figure 3.1 Thermal Imager IR Thermometer Description

1. Display area
2. Return button (to back up in the menu system)
3. Laser pointer button
4. Up/Down Navigation buttons & Power (long press)/Menu (short press) button
5. Lanyard post
6. Accessory mount
7. High temperature lever switch
8. 80 x 60 pixel Lepton® IR camera
9. Laser pointer with circular target-spot assist
10. USB-C jack compartment
11. Spot thermal sensor
12. Flashlight (LED)
13. 2M pixel visible spectrum camera
14. Image capture trigger (also used to exit the menu system)

3.2 Control Button Descriptions

	Long press to power ON or OFF Short press to access the menu system
	Return button. Back out to previous screen in menus
	Press to scroll upward in the menus
	Press to scroll downward in the menus
	Press and hold to use the Laser pointer
TRIGGER	Pull trigger to capture camera image Pull trigger to exit the menu system

3.3 Display Description

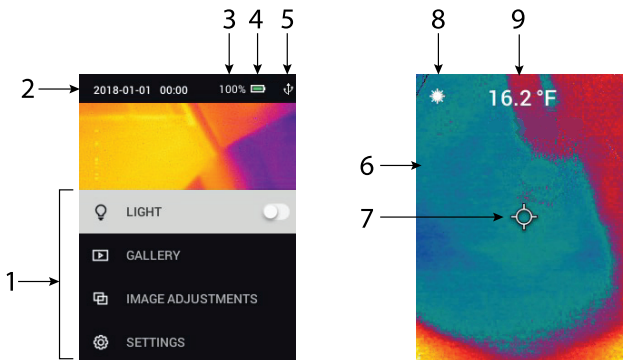

Figure 3.2 IRC130 Displays

1. Menu area
2. Date and time
3. Battery status percentage
4. Battery status indicator
5. USB connection active
6. Camera image area

7. Center spot cross-hairs
8. Laser Pointer active
9. Center spot temperature measurement

4 Operation

4.1 Powering the IRC130

The IRC130 is powered by a rechargeable lithium battery. Long press the power button (centre) to switch the unit ON or OFF. If the unit does not power ON, charge the battery by connecting to a 5V/1A rated AC wall charger (not supplied) using the supplied USB-C cable. The USB-C jack is located in the compartment at the top of the unit. Do not use the IRC130 while it is charging. When the top flap is closed, the unit is rated IP54 for encapsulation. See Section 7.2, *Battery Considerations and Service* for more information.

The IRC130 has an Auto Power OFF (APO) utility that switches it OFF automatically if no buttons are pressed for the duration of the selected APO time. Use the menu system (under *Device Settings*) To set the APO timer. See Section 5, *Programming Menu System*, for more information.

4.2 IR Camera and Thermometer

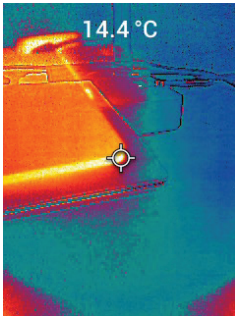

Figure 4.1 Combined Thermal and Visible Image (MSX®)

1. Long press the power button to switch the unit ON.
2. If not already selected, choose the Thermal plus Visible Image mode in the menu system (under *Image Adjustments/Image Mode*). You can adjust the MSX® (Multi-Spectral Dynamic Imaging) alignment in the *Image Mode* menu (press MENU at the MSX® image option and use the arrows to make the adjustments; press MENU to confirm). Note that you can also adjust the alignment directly in the normal operating mode using the arrow buttons while viewing a Thermal Plus Visible image.
3. Point the camera toward the test area and scan as desired. View the camera image on the IRC130 display.

4. Use the Laser pointer to accurately target a spot. Press the Laser pointer button to switch ON the Laser pointer. The Laser pointer includes a circular spot indicating the area that is being monitored for temperature, utilizing DOE (Diffractive Optical Elements) technology. See the Laser pointer image example below in **Figure 4.2**. If the Laser beam does not appear when the button is pressed, check the menu system (under *Device Settings*) to ensure that the Laser is enabled.
5. Use the cross-hair icon for reference only when targeting measurement spots, as parallax errors affect targeting accuracy. If the cross-hairs are not shown, check the menu system (under *Measurement*) to ensure that the Center Spot (cross-hairs) function is enabled.
6. The temperature reading on the display represents the measurement of the targeted spot. See **Figure 4.1**.
7. The distance-to-spot ratio is 30:1 and the minimum target distance is 10.2 in. (26 cm).
8. To measure higher than 752°F (400°C) use the High Temperature Switch, see Section 4.3 below.
9. If a measurement is out of range, the display will show 'OL'.
10. To adjust the Emissivity, use the menu system (under *Measurement*).
11. To change the display color palette, use the menu system (under *Image Adjustments/colors*).



Figure 4.2 Laser pointer with circular border indicating temperature measurement spot

4.3 High Temperature Switch

1. To access the high temperature mode, slide the lever to the right (to expose the red color code).
2. The lever is located directly below the lens area and above the image capture trigger.
3. When engaged, the high end of the temperature range (>752°F [400°C]) is accessible.

4.4 Visible Spectrum Camera



Figure 4.3 Visible Spectrum Digital Camera Image

1. Long press the power button to switch the IRC130 ON.
2. Select the Visible Image mode in the menu system (under *Image Adjustments/Image Mode*).
3. Point the camera toward the test area and scan as desired.
4. View the image on the display, see **Figure 4.3**.

4.5 Capture, View, Transfer, Send, and Delete Camera Images

1. To capture a camera image to the IRC130 internal memory, pull and release the trigger. Note that an image cannot be saved if a USB cable is connected to the unit.
2. After a successful image capture, a display confirmation will briefly appear showing the image filename.
3. To view images on the IRC130 display, access the *Gallery* mode in the main menu. In the Gallery, scroll through the stored images with the arrows and open an image with the MENU button.
4. To delete images, select the DELETE or DELETE ALL FILES command to erase the selected image or all of the stored images. Select CANCEL to exit the menu without making changes.
5. To transfer images to a PC, connect the unit to a PC using the supplied USB-C cable. The USB jack is located at the top of the unit under the flap. Once connected to the PC you can use the IRC130 as you would any external storage drive. Note: *Device is not 100% compatible with Mac OS, please do not format the internal memory via Mac OS.*

5 Programming Menu System

5.1 Menu System Basics

Short press the MENU button to access the menu system. Use the MENU button to switch settings ON or OFF, use the Return button to move to the previous screen, and use the arrows to scroll. In addition, the MENU button is used in some cases to confirm settings. Use the trigger to exit the menu system.

5.2 Main Menu

- **GALLERY:** Press MENU to access the stored images. Use the arrow buttons to scroll through the stored images and use the MENU button to open an image. Press MENU at an opened image to see the CANCEL/DELETE/DELETE ALL FILES menu.

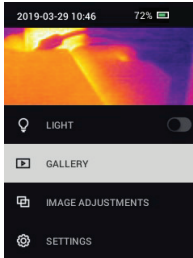

- **LIGHT:** Short press MENU to switch the Flashlight ON or OFF.

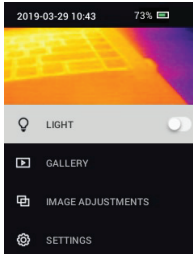

- **IMAGE ADJUSTMENTS:** Press MENU to access IMAGE MODES (including MSX® alignment) and colors, see below:

1. Image Modes: Press MENU at IMAGE MODES and use the arrow buttons to select VISIBLE IMAGE or THERMAL PLUS VISIBLE IMAGE (MSX®).

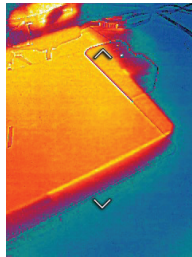
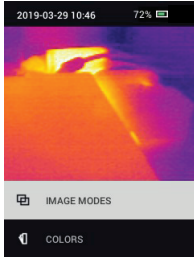

2. MSX® Alignment: Adjust the alignment (so that the thermal image and the visible image line up accurately) as follows: While viewing the THERMAL PLUS VISIBLE IMAGE screen in the menu, press MENU to access the MSX® adjustment screen and then use the arrow buttons to adjust the alignment. Press MENU to confirm. Note that you can also adjust the alignment directly in the normal operating mode using the arrow buttons while viewing a Thermal Plus Visible image.

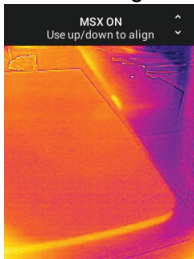

3. Colors: Press MENU at the colors menu and use the arrow buttons to select a color palette: Iron, Rainbow, White hot, Black hot, Arctic, or Lava. Press MENU to confirm selection.

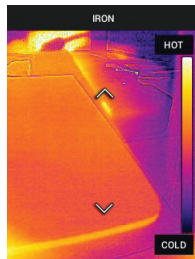
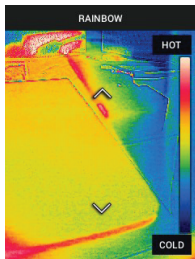
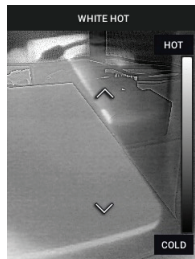
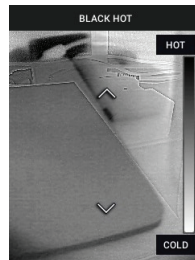
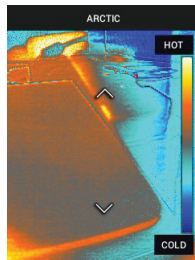
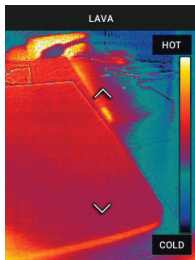
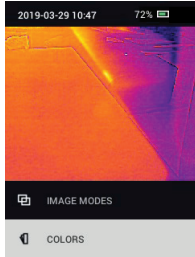

- **SETTINGS:** Press MENU to access the Settings sub-menu (see below):

5.3 SETTINGS Sub-Menu

- **MEASUREMENT**

1. Center Spot: Press MENU to enable/disable the display cross-hairs. The cross-hairs should be used as a reference only to identify the spot that is being measured for temperature. Use the Laser pointer for more accurate targeting.

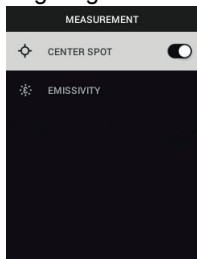

2. Emissivity: Press MENU to open the Emissivity adjustment utility. Use the arrows to scroll through the presets (0.95, 0.80, and 0.60) and use the MENU button to select a preset. Choose the Custom Value utility (last selection on the list) to select a specific emissivity value. At the Custom Value setting, press MENU and then use the arrows to select the emissivity value; press MENU to confirm.

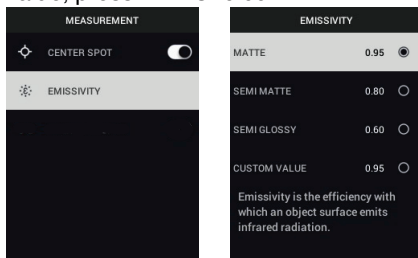

- **DEVICE SETTINGS**

1. Laser: Press MENU to enable/disable the Laser pointer. When enabled, you can use the Laser pointer button to switch ON the Laser pointer. Use the Laser pointer for accurate targeting of measurement spots.

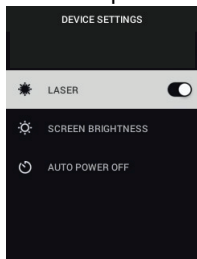

2. Screen brightness: Use the arrows to select the desired display intensity (LOW, MEDIUM, or HIGH).

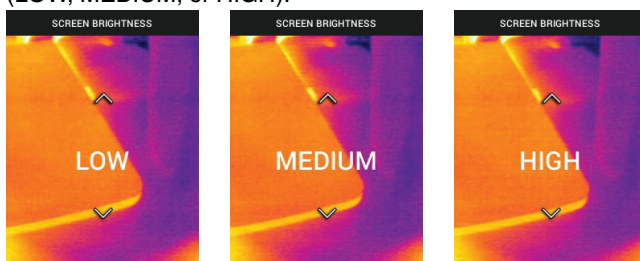

3. Auto Power Off (APO): Use the arrows to scroll and MENU to select the desired APO time (5/15/30 minutes). Set to 'Never' to disable APO.

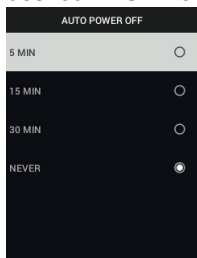

- **GENERAL SETTINGS**

1. Temperature Unit: Use the arrows and the MENU button to select °C or °F.

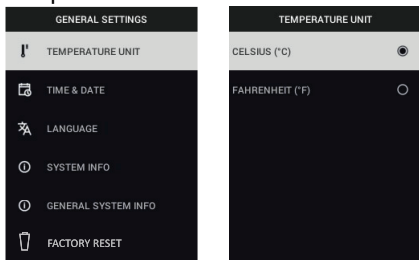

2. Time & Date: Use the arrows to scroll and the MENU button to set the Time, Date, Time Format, and Date Format.

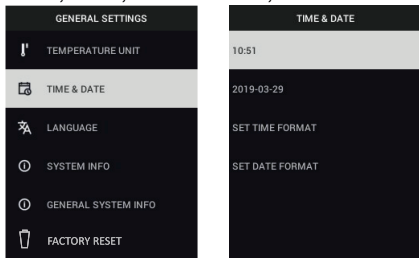

3. Language: Use the arrows to scroll and the MENU button to select a language.

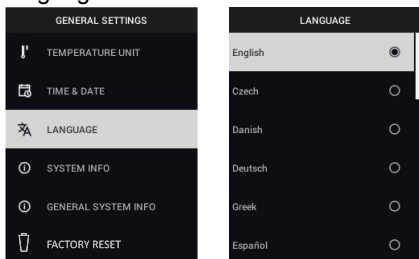

- 4. System Info: Scroll to desired topic: **Model Number**, **Serial Number**, **Software Level**, **Revision**, **Battery status (%)**, and remaining **Internal Storage Capacity**.

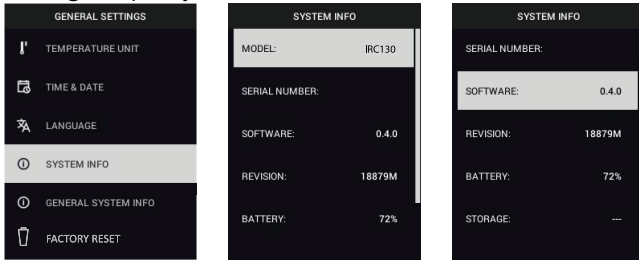

- **GENERAL SYSTEM INFO:** Press MENU to view compliance information.

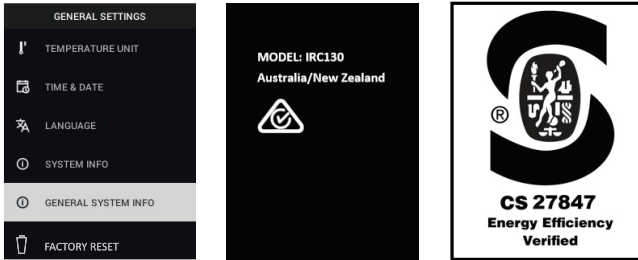

- **FACTORY RESET:** Follow the prompts to reset the User Settings back to Factory Default status.

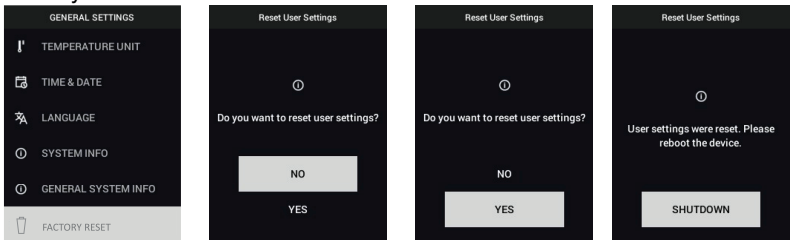

6 Field Firmware Updates

The IRC130 includes a USB-C port in the top compartment. The USB port allows the user to update the system firmware by first downloading an update file from the FLIR website and then connecting the unit to a PC (using the supplied USB-C cable) to copy the file. Firmware updates are available from <https://support.flir.com>.

NOTE

The IRC130 is not 100% compatible with USB-C to USB-C cables. Use only USB-C to USB-A cables. The supplied cable is USB-C to USB-A.

To update the firmware, you will need:

- Access to the website where the update file is located: <https://support.flir.com>
- The IRC130 to be updated
- The update file. Refer to the steps in the next section:

6.1 System Firmware Update

1. Visit <https://support.flir.com> to obtain a firmware update file.
2. Select the 'Downloads' tab and then select 'Software and Firmware'.
3. Search for 'IRC130'.
4. Select and download the firmware update file to the PC.
5. With the IRC130 **ON** connect it to the PC via a USB-C cable (the USB-C port is located in the top compartment).
6. Copy the firmware update file to the IRC130 root directory.
7. Eject the IRC130 drive from the PC.
8. Disconnect the USB cable from the PC USB port and from the IRC130 USB port.
9. Follow the IRC130 display prompts to complete the update.

7 Maintenance

7.1 Cleaning

Wipe the housing with a damp cloth as needed. Do not use abrasives or solvents. Clean the lenses with a high-quality lens cleaner.

7.2 Battery Considerations and Service

The rechargeable lithium battery is not user-serviceable. Please contact us for service instructions: <https://support.flir.com>.

For best results, charge the battery immediately after seeing a low battery indication using the supplied USB-C cable (with an AC wall charger, not supplied). The wall charger must be rated for at least 5V/1A. If the battery is allowed to fully drain, allow 2~3 hours before the charging display appears after connecting to an AC charger; a full charge (100%) requires 6 hours, a charge to 90% power requires 4 hours. Charging through a PC USB port is not recommended.

If the unit is not going to be used for an extended period (> 3 months), it should be charged to at least 70%, stored at room temperature, and recharged every 6 months. Failure to do so may result in a battery that cannot be recharged and that therefore will require service.

7.3 Disposal of Electronic Waste



As with most electronic products, this equipment must be disposed of in an environmentally friendly way, and in accordance with existing regulations for electronic waste. Please contact us for additional information.

7.4 Reset the IRC130

If the display freezes or if the unit in any way stops operating normally, press and hold the up and down buttons for at least 10 seconds. Release the buttons when the unit switches OFF. After the unit switches OFF, switch it back ON again to resume use. No data will be lost by resetting the unit. If problems persist, contact us for support.

8 Specifications

8.1 Imaging and Optical Specifications

IR resolution	80 x 60 pixels
Digital image enhancement	Included
Thermal Sensitivity /NETD	< 70 mK
Field of View (FOV)	51° x 66 (H x W)°
Minimum focus distance	0.89 ft. (0.3 m)
Distance-to-Spot ratio	30:1
Dual range operation	Range 1: < 752°F (400°C) Range 2: > 752°F (400°C) For Range 2, the high temperature lever must be engaged
Focus	Fixed
Image frequency	8.7 Hz

8.2 Detector Specifications

Focal plane array /Spectral response range	Uncooled microbolometer /7.5 ~ 14 μm
Detector pitch	12 μm

8.3 Image Presentation Specifications

Display resolution	320 x 240 pixels
Screen size	2.4 in. (portrait)
Viewing angle	80°
Color depth	24 bit
Aspect ratio	4:3
Display type	TFT technology
Image adjustment	Automatic
Image modes	Thermal MSX® (Multi-Spectral Dynamic Imaging) and Visible Spectrum modes.

8.4 Measurement Specifications

Object temperature range	-13°F ~ 1202°F (-25°C ~ 650°C)
Accuracy at ambient temperature: 15°C ~ 35°C (59°F ~ 95°F)	-13°F ~ 32°F (-25°C ~ 0°C): ± 7.0°F (3.0°C)
	32°F ~ 122°F (0°C ~ 50°C): ± 5.0°F or ± 2.5% (±2.5°C or ± 2.5%) whichever is greater
	122°F ~ 212°F (50°C ~ 100°C): ± 3.0°F or ± 1.5% (± 1.5°C or ± 1.5%) whichever is greater
	213°F ~ 932°F (100°C ~ 500°C): ± 6.0°F or ± 2.5% (± 2.5°C or ± 2.5%) whichever is greater
	933°F ~ 1202°F (500°C ~ 650°C): ± 7.0°F or ± 3.0% (± 3.0°C or ± 3.0%) whichever is greater
IR Temperature resolution	0.2°F (0.1°C)
Reading repeatability	± 1 % of reading or ± 2°F (1°C), whichever is greater
Response time	150 ms
IR thermometer measurement	Continuous scanning
Minimum measurement distance	0.85 ft. (0.26 m)

8.5 Measurement Analysis Specifications

Spot meter	Center spot (cross-hairs); Programmable ON/OFF
Color display palettes	Iron, Rainbow, White-hot, Black-hot, Arctic, and Lava

8.6 Configuration Specifications

Set-up commands	Local adaptation of units, language, date and time formats
Emissivity adjustment	3 presets plus a custom adjustment utility (0.1 ~ 0.99)

Languages	Czech, Danish, Dutch, English, Finnish, French, German, Greek, Hungarian, Italian, Japanese, Korean, Norwegian, Polish, Portuguese, Russian, simplified Chinese, Spanish, Swedish, traditional Chinese, Turkish
Firmware updates	User manageable (instructions included in this user manual)

8.7 Image Storage Specifications

Storage media	eMMC 4G
Image storage capacity	50000 images
Image file format	JPEG with spot temperature metadata tag

8.8 Digital Camera

Resolution	2M pixels
Focus	Fixed
Field of View (FOV)	71° x 56° (adapts to IR lens)

8.9 Flashlight Specifications

Flashlight type	Bright LED
LED CCT	6500° K
LED CRI	70
Beam angle	± 20°
Rated power	0.5 W
Light output	100 Lumens

8.10 Laser Pointer Specifications

Laser type	DOE (Diffractive Optical Elements)
Laser function	Indicates the size of the measurement area (circular target)
Laser class	Class I

8.11 Data Interface Specifications

Interface	USB
USB type	USB-C for data transfer and battery charging Not 100% compatible with USB-C to USB-C cables. Use only USB-C to USB-A cables.
USB standard	USB 2.0 High Speed

8.12 Rechargeable Battery Specifications

Battery type	Rechargeable Lithium ion
Battery voltage	3.6 V
Battery operating time	5 hours scanning (medium brightness setting) 4.5 hours with Laser ON (medium brightness setting)
Battery charge life	30 days minimum
Charging system	Battery is charged inside the IRC130
Charging time	4 hours to 90% and 6 hours to 100%
Power management	APO adjustable 5/15/30 minutes. Can be disabled.

8.13 Environmental Specifications

Altitude	6562 ft. (2000 m)
Pollution degree	2
Operating temperature	14°F ~ 113°F (-10°C ~ 45°C)
Storage temperature	-22°F ~ 131°F (-30°C ~ 55°C)
Humidity (operating and storage)	0 ~ 90% Relative Humidity (RH) 32°F ~ 98.6°F (0°C ~ 37°C) 0 ~ 65% RH 98.6°F ~ 113°F (37°C ~ 45°C) 0 ~ 45% RH 113°F ~ 131°F (45°C ~ 55°C)
EMC	EN 61000-6-3 EN 61000-6-2 FCC 47 CFR Part 15 Class B

Magnetic fields	EN 61000-4-8 Class 3
Encapsulation	IP54 (IEC 60529)
Shock	25 g (IEC 60068-2-27)
Vibration	2 g (IEC 60068-2-6)
Drop	Designed for 6.56 ft. (2 m)
Safety	CE/CB/EN61010/UL
Environmental safety	REACH Regulation EC 1907/2006 RoHS 2 Directive 2011/65/EC WEEE Directive 2012/19/EC JIS C 6802:2011 laser directive IEC 60825-1 class I laser directive FDA laser directive
Humidity requirements	IEC 60068-2-30 for operation and storage

8.14 Physical Specifications

Weight	13.9 oz. (0.39 kg)
Size (L x W x H)	8.3 x 2.5 x 3.2 in. (210 x 64 x 81 mm)
Accessory mount	UNC ¼"-20

8.15 Included Equipment

Standard equipment	IRC130, USB-C cable, printed Quick Start, Lanyard, and Pouch
--------------------	--

9 Warranty and Customer Support

9.1 Two-Year Warranty

FLIR Systems, Inc. warrants this Extech brand instrument to be free of defects in parts and workmanship for **two years** from date of shipment (a six-month limited warranty applies to sensors and cables). To view the full warranty text please visit: <https://www.extech.com/warranty>.

9.2 Repair and Calibration Services

FLIR Systems, Inc. offers calibration and repair services for the Extech brand products we sell. We offer NIST traceable calibration for most of our products. Contact us for information on calibration and repair availability. Annual calibrations should be performed to verify meter performance and accuracy. Product specifications are subject to change without notice. Please visit our website for the most up-to-date product information: www.extech.com.

9.3 Customer Support

Customer Support Telephone:

U.S. (866) 477-3687

International +1 (603) 324-7800

Calibration, Repair, and Returns email: repair@extech.com

Technical Support: <https://support.flir.com>

Corporate Headquarters: FLIR Systems, Inc., 27700 SW Parkway Ave., Wilsonville, OR 97070, USA

copyright © FLIR Systems, Inc.

All rights reserved including the right of reproduction in whole or in part in any form.

www.extech.com