

Display Elektronik GmbH

# DATA SHEET

**LCD MODULE**

## DEM 24251 SYH-PY

*Product specification*

*Version : 0*

09.04.2003

**CONTENTS**

- 1. FUNCTIONS & FEATURES.....2
- 2. MECHANICAL SPECIFICATION.....2
- 3. BLOCK DIAGRAM..... 2
- 4. EXTERNAL DIMENSIONS..... 3
- 5. PIN ASSIGNMENT.....3
- 6.1 PCB DRAWING AND DESCRIPTION.....4
- 6.2 EXAMPLE APPLICATION..... 5
- 6.3 THE MODULE NO. IS PRINTED ON THE PCB.....5
- 7. BACKLIGHT & SWITCH.....6
- 8. DISPLAY DATA RAM.....6
- 9. MAXIMUM ABSOLUTE LIMIT.....7
- 10. ELECTRICAL CHARACTERISTICS..... 7
  - 10-1 DC CHARACTERISTICS.....7
  - 10-2 AC CHARACTERISTICS.....8
    - 10-2-1 WRITE MODE..... 8
    - 10-2-2 READ MODE.....9
- 11. CONTROL AND DISPLAY COMMAND..... 10
- 12. LCM INITIALIZING BY INSTRUCTION..... 11
  - 12-1 8-BIT INTERFACE MODE..... 11
  - 12-2 4-BIT INTERFACE MODE.....12
- 13. Character Code-Map (KS0066B-00).....13
- 14. LCD MODULES HANDLING PRECAUTIONS..... 14
- 15. OTHERS.....14

**1. FUNCTIONS & FEATURES**

- DEM 24251-Series :

MODULE	LCD MODEL	LCD TYPE
DEM 24251 SYH-PY	STN Yellow/Green	Transflective Positive Mode

- Viewing Direction : 6 O'clock
- Driving Scheme : 1/16 Duty Cycle, 1/5 Bias
- Power Supply Voltage : 2.7V to 5.5 V (typ. 5V)
- Backlight Color : Yellow Green (lightpipe/lightguide)
- $V_{LCD}$  Adjustable For Best Contrast : 4.5 V (typ.)
- Display Format : 24 x 2 Characters
- Operation temperature : -20°C to +70°C
- Storage temperature : -25°C to +75°C
- Internal Memory : CGROM (10,080 bits )  
: CGRAM (64 x 8 bits )  
: DDRAM (80 x 8 bits )
- CGROM : CGROM of the KS0066U-00
- Interface : Easy Interface with 4-bit or 8-bit MPU

**2. MECHANICAL SPECIFICATIONS**

- Character Pitch : 3.20 (W) x 6.05 (H) mm
- Character Size : 2.70 (W) x 5.55 (H) mm
- Character Font : 5 x 8 dots
- Dot Size : 0.50 (W) x 0.65 (H) mm
- Dot Pitch : 0.55 (W) x 0.70 (H) mm

**3. BLOCK DIAGRAM**

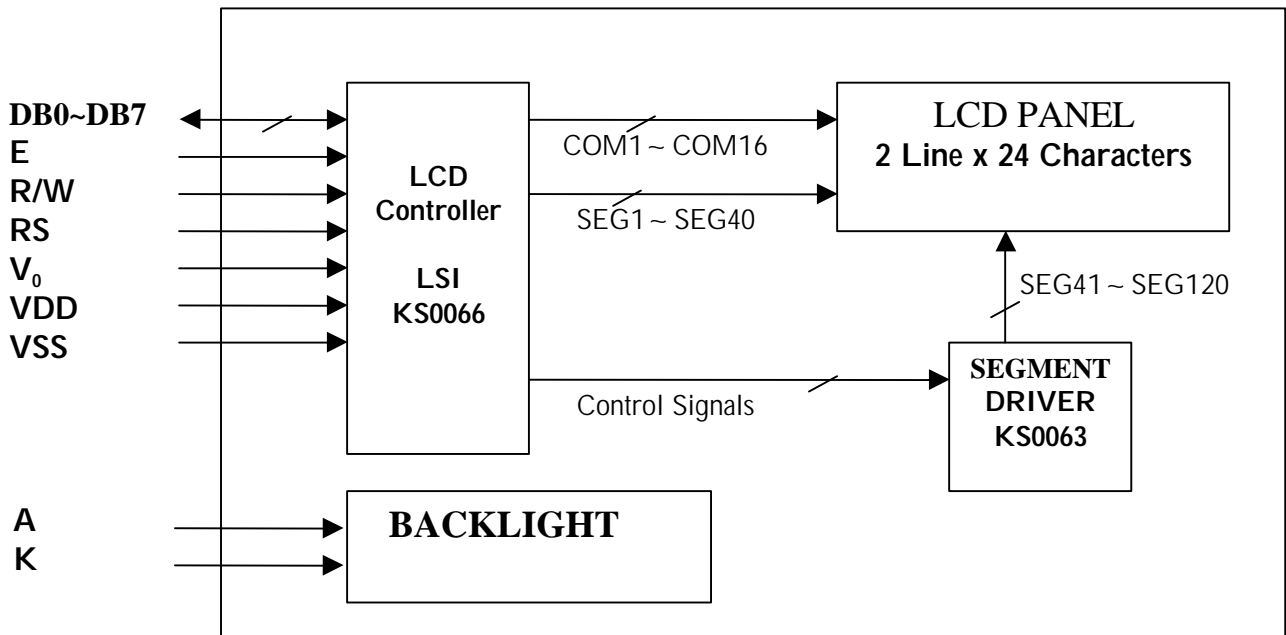

**4. EXTERNAL DIMENSIONS**

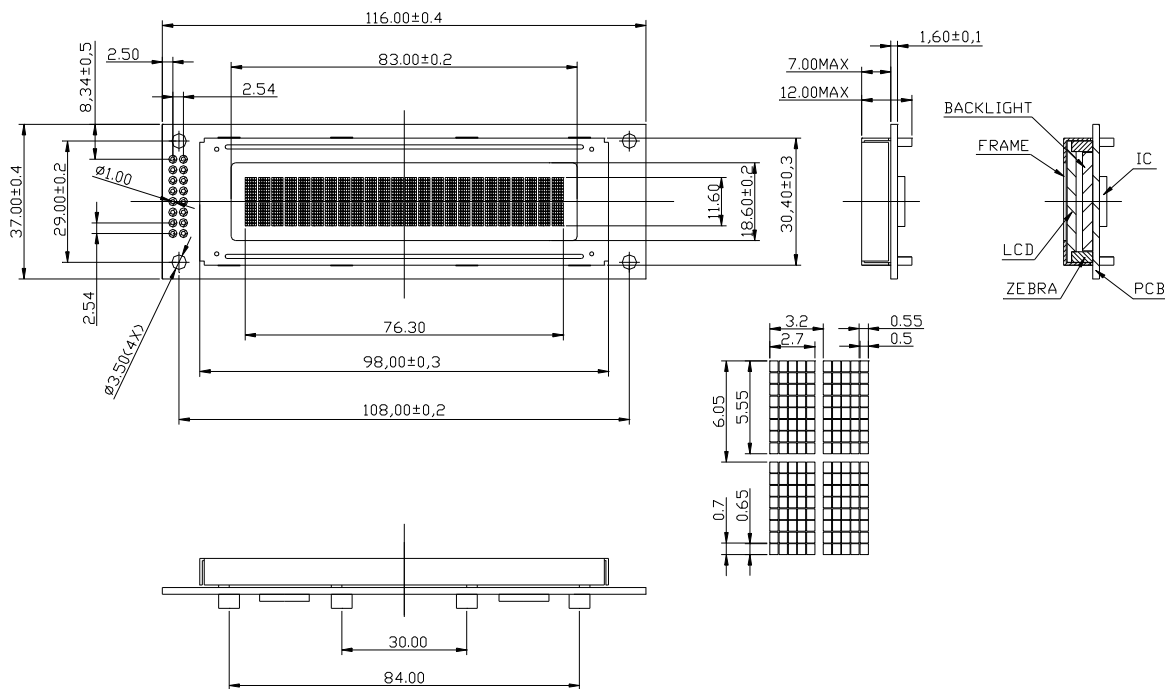

**5. PIN ASSIGNMENT**

Pin No.	Symbol	Function
1	V <sub>SS</sub>	Ground terminal of module.
2	V <sub>DD</sub>	Power terminal of module 2.7V to 5.5V.
3	V <sub>0</sub>	Power Supply for liquid crystal drive.
4	RS	Register select RS = 0...Instruction register RS = 1...Data register
5	R/W	Read /Write R/W = 1 (Read) R/W = 0 (Write)
6	E	Read/Write Enable Signal
7	DB0	Bi-directional data bus, data transfer is performed once, thru DB0 to DB7, in the case of interface data. Length is 8-bits; and twice, thru DB4 to DB7 in the case of interface data length is 4-bits. Upper four bits first then lower four bits.
8	DB1	
9	DB2	
10	DB3	
11	DB4	
12	DB5	
13	DB6	
14	DB7	
15	LED – (K)	Please also refer to 6.1 PCB drawing and description.
16	LED + (A)	Please also refer to 6.1 PCB drawing and description.

**6.1 PCB DRAWING AND DESCRIPTION**

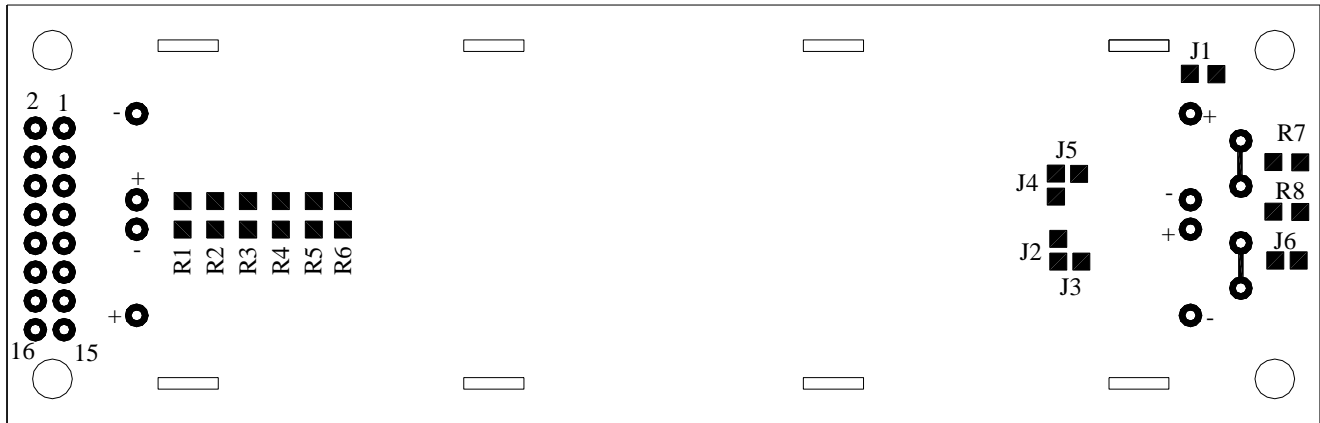

**DESCRIPTION:**

6-1-1. The polarity of the pin 15 and the pin 16

symbol	state	symbol	J3,J5	J2,J4	LED Polarity	
					15 Pin	16 Pin
J2,J4	Each solder-bridge	Each open	-----	Anode	Cathode	
J3,J5	Each solder-bridge	-----	Each open	Cathode	Anode	

6-1-2. The metal-bezel should be on ground when the J1 is solder-Bridge.

6-1-3. The LED resistor should be bridged when the J6 is solder-Bridge.

6-1-4. The R7 and the R8 are the LED resistor. (R7 = 10 Ohm, R8 = OPEN).

**6.2 Example application**

6-2-1. The LED resistor should be bridged as following.

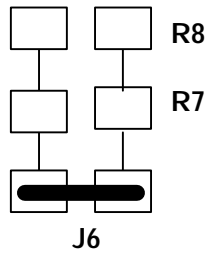

6-2-2. The 15 pin is the anode and the 16 pin is the cathode as following.



6-2-3. The 15 pin is the cathode and the 16 pin is the anode as following.



6-2-4. The metal-bezel is on ground as following.



**6.3 The module NO. Is printed on the PCB.**

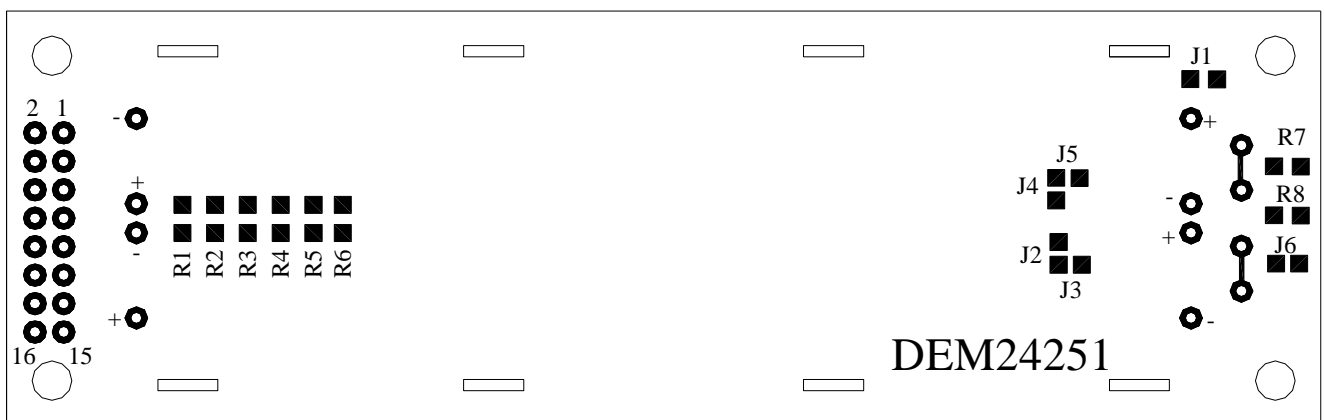

**7. BACKLIGHT & SWITCH ( Ta = -20 ~ +70°C)**

Item	Symbol	Standard Value	Unit	Applicable Terminal
Backlight Voltage	V	5.0	V	LED+ / LED-
Backlight Current	I	~68	mA	

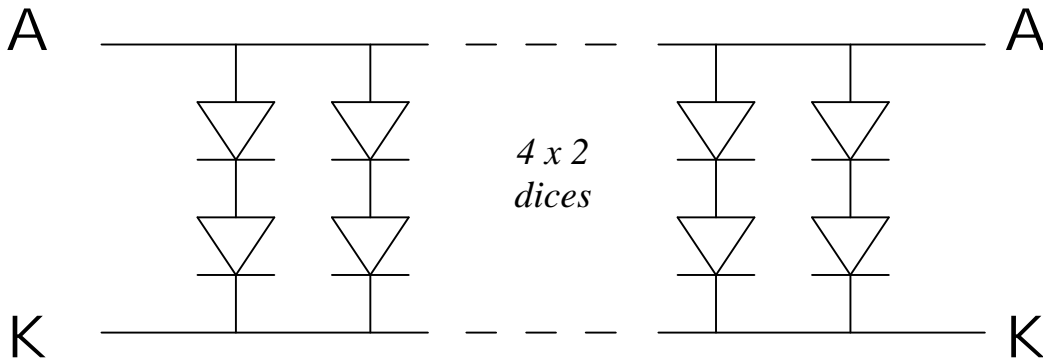

**8. DISPLAY DATA RAM (DDRAM)**

	1	2	...	10	11	12	13	14	15	16	17	18	...	24	← DISPLAY POSITION
FIRST LINE	00	01	...	09	0A	0B	0C	0D	0E	0F	10	11	...	17	← DDRAM ADDRESS
SECOND LINE	40	41	...	49	4A	4B	4C	4D	4E	4F	50	51	...	57	

**9. MAXIMUM ABSOLUTE LIMIT**

Item	Symbol	Standard value	Unit
Power supply voltage(1)	$V_{DD}$	-0.3 ~ +7.0	V
Power supply voltage(2)	$V_{LCD}$	$V_{DD}-15.0 \sim V_{DD}+0.3$	V
Input voltage	$V_{IN}$	-0.3 ~ $V_{DD}+0.3$	V
Volt. For BL	$V_{LED1}$	4 ~ 4.5	V
Operating temperature	$T_{opr}$	-20 ~ +70	°C
Storage temperature	$T_{stg}$	-25 ~ +75	°C

**10. ELECTRICAL CHARACTERISTICS**

**10-1 DC Characteristics (VDD = 4.5V ~ 5.5V, Ta = -20 ~ +70°C)**

Item	Symbol	Standard Value			Test Condition	Unit
		MIN	TYP	MAX		
Operating Voltage	$V_{DD}$	4.5	5	5.5	-----	V
Supply Current	$I_{DD}$	----	0.35	0.6	$V_{DD}=5V, f_{osc}=270kHz$	mA
Input Voltage(1) (except OSC1)	$V_{IL1}$	-0.3	--	0.6	-----	V
	$V_{IH1}$	2.2	--	$V_{DD}$	-----	
Input Voltage(2) (OSC1)	$V_{IL2}$	-0.2	--	1.0	-----	V
	$V_{IH2}$	$V_{DD}-1.0$	--	$V_{DD}$	-----	
Output Voltage (1) (DB0 to DB7)	$V_{OL1}$	---	----	0.4	$I_{OL}=1.2mA$	V
	$V_{OH1}$	2.4	---	----	$I_{OH}=-0.205mA$	
Output Voltage (2) (except DB0 to DB7)	$V_{OL2}$	-----	---	$0.1V_{DD}$	$I_{OL}=40\mu A$	V
	$V_{OH2}$	$0.9V_{DD}$	---	-----	$I_{OH}=-40\mu A$	
Voltage Drop	$V_{dCOM}$	-----	---	1	$I_O = \pm 0.1 mA$	V
	$V_{dSEG}$	-----	---	1		
Input Leakage Current	$I_{IKG}$	-1	---	1	$V_{IN}=0 V \text{ to } V_{DD}$	uA
Input Low Current	$I_{IL}$	-50	-125	-250	$V_{IN}=0V, V_{DD}=5V(\text{pull up})$	uA
Internal Clock (external Rf)	$f_{OSC1}$	190	270	350	$R_f = 91k\Omega \pm 2\%$ $(V_{DD}=5V)$	kHz
External Clock	$f_{OSC}$	125	270	410	----	kHz
	Duty	45	50	55	----	%
	$t_r, t_f$	---	---	0.2	----	us
LCD Driving Voltage	$V_{LCD}$	3.0	---	13.0	$V_{DD}-V_5(1/5, 1/4 \text{ Bias})$	V



**10-2 AC Characteristics ( $V_{DD} = 4.5V \sim 5.5V$ ,  $T_a = -20 \sim +70^{\circ}C$ )**

**10-2-1 Write mode (writing data from MPU to DEM 24251-Series)**

Characteristic	Symbol	Min	Type	Max	Unit	Test PIN
E Cycle Time	$t_c$	500	---	---	ns	E
E Rise Time	$t_R$	---	---	20	ns	E
E Fall Time	$t_F$	---	---	20	ns	E
E Pulse width (High,Low)	$t_w$	230	---	---	ns	E
R/W and RS Set-up Time	$t_{SU1}$	40	---	---	ns	R/W,RS
R/W and RS Hold Time	$t_{H1}$	10	---	---	ns	R/W,RS
Data Set-up Time	$t_{SU2}$	80	---	---	ns	DB0~DB7
Data Hold Time	$t_{H2}$	10	---	---	ns	DB0~DB7

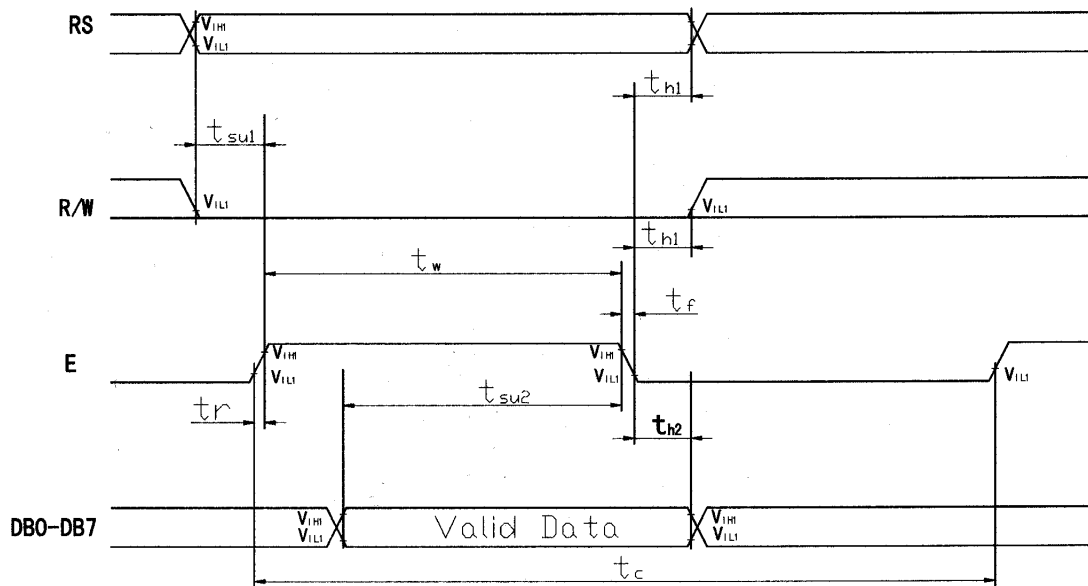

10-2-2 Read mode (reading data from MPU to DEM 24251-Series )

Characteristic	Symbol	Min	Type	Max	Unit	Test PIN
E Cycle Time	$t_c$	500	---	---	ns	E
E Rise Time	$t_R$	---	---	20	ns	E
E Fall Time	$t_F$	---	---	20	ns	E
E Pulse width (High, Low)	$t_w$	230	---	---	ns	E
R/W and RS Set-up Time	$t_{SU}$	40	---	---	ns	R/W,RS
R/W and RS Hold Time	$t_H$	10	---	---	ns	R/W,RS
Data Output Delay Time	$t_D$	---	---	120	ns	DB0~DB7
Data Hold Time	$t_{DH2}$	5	---	---	ns	DB0~DB7

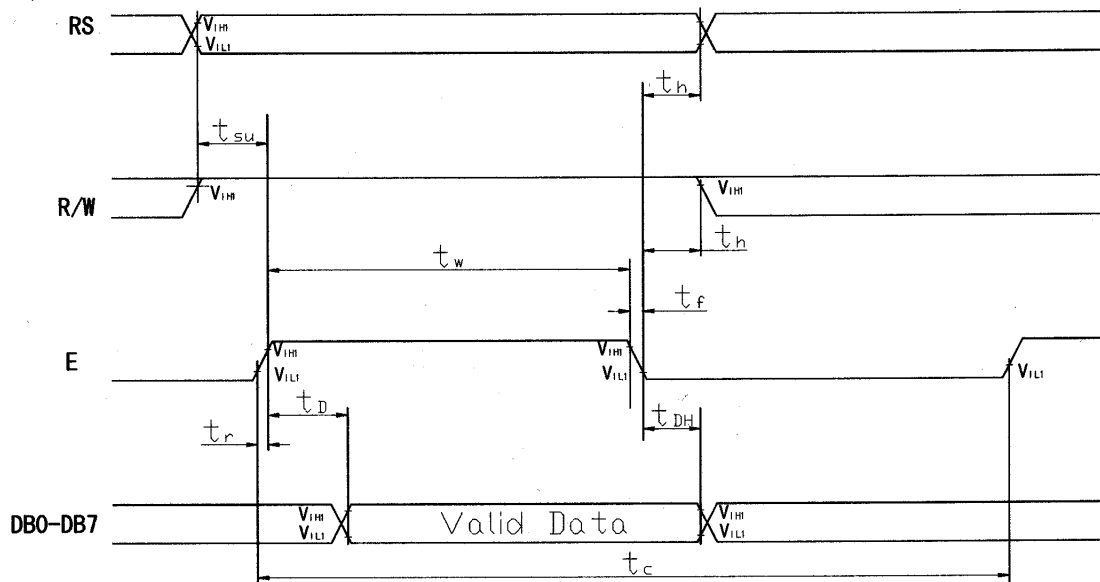

11. CONTROL AND DISPLAY COMMAND

Command	RS	R/W	DB7	DB6	DB5	DB4	DB3	DB2	DB1	DB0	Execution time (fosc=270KHz)	Remark																		
clear Display	L	L	L	L	L	L	L	L	L	H	1.53ms	Write "20H" to DDRAM and set DDRAM address to "00H" from AC																		
Return home	L	L	L	L	L	L	L	L	H	---	1.53ms	Cursor move to first digit																		
Entry mode set	L	L	L	L	L	L	L	H	I/D	SH	39us	I/D:set cursor move direction <table border="1" style="margin-left: 20px;"> <tr><td>I/D</td><td>H</td><td>Increase</td></tr> <tr><td>I/D</td><td>L</td><td>Decrease</td></tr> </table> SH:Specifies shift of display <table border="1" style="margin-left: 20px;"> <tr><td>SH</td><td>H</td><td>Display is shifted</td></tr> <tr><td>SH</td><td>L</td><td>Display is not shifted</td></tr> </table>	I/D	H	Increase	I/D	L	Decrease	SH	H	Display is shifted	SH	L	Display is not shifted						
I/D	H	Increase																												
I/D	L	Decrease																												
SH	H	Display is shifted																												
SH	L	Display is not shifted																												
Display on/off control	L	L	L	L	L	L	H	D	C	B	39us	Display <table border="1" style="margin-left: 20px;"> <tr><td>D</td><td>H</td><td>Display on</td></tr> <tr><td>D</td><td>L</td><td>Display off</td></tr> </table> Cursor <table border="1" style="margin-left: 20px;"> <tr><td>C</td><td>H</td><td>Cursor on</td></tr> <tr><td>C</td><td>L</td><td>Cursor off</td></tr> </table> Blinking <table border="1" style="margin-left: 20px;"> <tr><td>B</td><td>H</td><td>Blinking on</td></tr> <tr><td>B</td><td>L</td><td>Blinking off</td></tr> </table>	D	H	Display on	D	L	Display off	C	H	Cursor on	C	L	Cursor off	B	H	Blinking on	B	L	Blinking off
D	H	Display on																												
D	L	Display off																												
C	H	Cursor on																												
C	L	Cursor off																												
B	H	Blinking on																												
B	L	Blinking off																												
Cursor or Display Shift	L	L	L	L	L	H	S/C	R/L	---	---	39us	<table border="1" style="margin-left: 20px;"> <tr><td>SC</td><td>H</td><td>Display shift</td></tr> <tr><td>SC</td><td>L</td><td>Cursor move</td></tr> </table> <table border="1" style="margin-left: 20px;"> <tr><td>R/L</td><td>H</td><td>Right shift</td></tr> <tr><td>R/L</td><td>L</td><td>Left shift</td></tr> </table>	SC	H	Display shift	SC	L	Cursor move	R/L	H	Right shift	R/L	L	Left shift						
SC	H	Display shift																												
SC	L	Cursor move																												
R/L	H	Right shift																												
R/L	L	Left shift																												
function Set	L	L	L	L	H	DL	N	F	---	---	39us	<table border="1" style="margin-left: 20px;"> <tr><td>DL</td><td>H</td><td>8bits interface</td></tr> <tr><td>DL</td><td>L</td><td>4bits interface</td></tr> </table> <table border="1" style="margin-left: 20px;"> <tr><td>N</td><td>H</td><td>2 line display</td></tr> <tr><td>N</td><td>L</td><td>1 line display</td></tr> </table> <table border="1" style="margin-left: 20px;"> <tr><td>F</td><td>H</td><td>Display on</td></tr> <tr><td>F</td><td>L</td><td>Display off</td></tr> </table>	DL	H	8bits interface	DL	L	4bits interface	N	H	2 line display	N	L	1 line display	F	H	Display on	F	L	Display off
DL	H	8bits interface																												
DL	L	4bits interface																												
N	H	2 line display																												
N	L	1 line display																												
F	H	Display on																												
F	L	Display off																												
Set CGRAM address	L	L	L	H	AC5	AC4	AC3	AC2	AC1	AC0	39us	CGRAM data is sent and received after this setting																		
Set DDRAM address	L	L	H	AC6	AC5	AC4	AC3	AC2	AC1	AC0	39us	DDRAM data is sent and received after this setting																		
Read busy flag& address	L	H	BF	AC6	AC5	AC4	AC3	AC2	AC1	AC0	0us	<table border="1" style="margin-left: 20px;"> <tr><td>BF</td><td>H</td><td>Busy</td></tr> <tr><td>BF</td><td>L</td><td>Ready</td></tr> </table> -Reads BF indication internal operating is being performed -Reads address counter contents	BF	H	Busy	BF	L	Ready												
BF	H	Busy																												
BF	L	Ready																												
Write data to RAM	H	L	D7	D6	D5	D4	D3	D2	D1	D0	43us	Write data into DDRAM or CGRAM																		
Read data from RAM	H	H	D7	D6	D5	D4	D3	D2	D1	D0	43us	Read data from DDRAM or CGRAM																		

12. LCM INITIALIZING BY INSTRUCTION

12-1. 8-bit interface mode

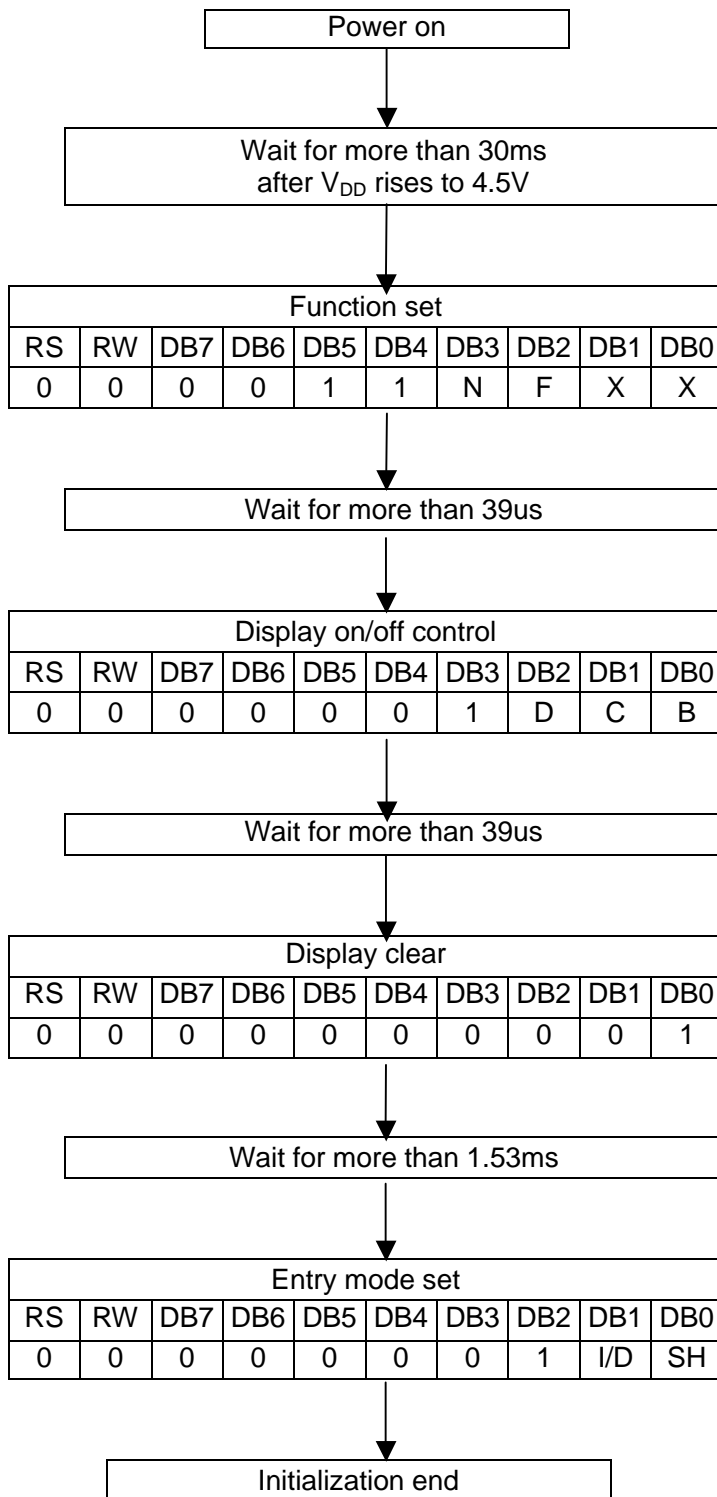

Condition : fosc=270khz

N	0	1-line mode
	1	2-line mode

F	0	display off
	1	display on

D	0	display off
	1	display on

C	0	cursor off
	1	cursor on

B	0	blink off
	1	blink on

I/D	0	decrement mode
	1	increment mode

SH	0	entire shift off
	1	entire shift on

12-2. 4-bit interface mode

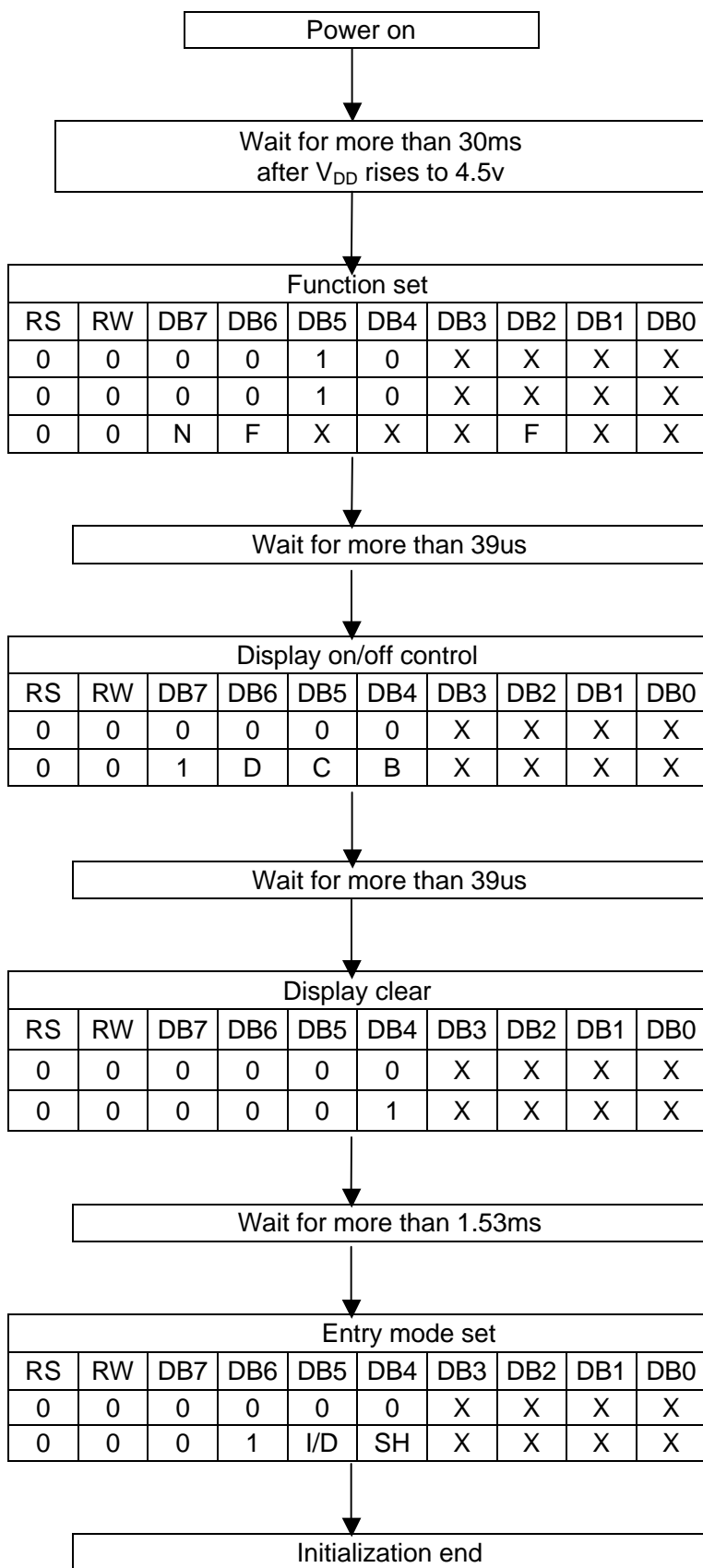

Condition : fosc=270khz

N	0	1-line mode
	1	2-line mode
F	0	display off
	1	display on

D	0	display off
	1	Display on
C	0	cursor off
	1	cursor on
B	0	blink off
	1	blink on

I/D	0	decrement mode
	1	increment mode
SH	0	entire shift off
	1	entire shift on

13. Character Code-Map (KS0066B-00)

Upper(4bit) \ Lower(4bit)	LLLL	LLHL	LLHH	LHLL	LHLH	LHHL	LHHH	HLLL	HLLH	HLHL	HLHH	HHLL	HHLH	HHHL	HHHH
LLLL	CG RAM (1)														
LLLH	(2)														
LLHL	(3)														
LLHH	(4)														
LHLL	(5)														
LHLH	(6)														
LHHL	(7)														
LHHH	(8)														
HLLL	(1)														
HLLH	(2)														
HLHL	(3)														
HLHH	(4)														
HHLL	(5)														
HHLH	(6)														
HHHL	(7)														
HHHH	(8)														

**14. LCD Modules Handling Precautions**

- The display panel is made of glass. Do not subject it to a mechanical shock by dropping it from a high place, etc.
- If the display panel is damaged and the liquid crystal substance inside it leaks out, do not get any in your mouth. If the substance come into contact with your skin or clothes promptly wash it off using soap and water.
- Do not apply excessive force to the display surface or the adjoining areas since this may cause the color tone to vary.
- The polarizer covering the display surface of the LCD module is soft and easily scratched. Handle this polarize carefully.
- To prevent destruction of the elements by static electricity, be careful to maintain an optimum work environment.
  - Be sure to ground the body when handling the LCD module.
  - Tools required for assembly, such as soldering irons, must be properly grounded.
  - To reduce the amount of static electricity generated, do not conduct assembly and other work under dry conditions.
  - The LCD module is coated with a film to protect the display surface. Exercise care when peeling off this protective film since static electricity may be generated.
- Storage precautions  
When storing the LCD modules, avoid exposure to direct sunlight or to the light of fluorescent lamps. Keep the modules in bags designed to prevent static electricity charging under low temperature / normal humidity conditions (avoid high temperature / high humidity and low temperatures below 0°C).Whenever possible, the LCD modules should be stored in the same conditions in which they were shipped from our company.

**15. Others**

- Liquid crystals solidify at low temperature (below the storage temperature range) leading to defective orientation of liquid crystal or the generation of air bubbles (black or white). Air bubbles may also be generated if the module is subjected to a strong shock at a low temperature.
- If the LCD modules have been operating for a long time showing the same display patterns may remain on the screen as ghost images and a slight contrast irregularity may also appear. Abnormal operating status can be resumed to be normal condition by suspending use for some time. It should be noted that this phenomena does not adversely affect performance reliability.
- To minimize the performance degradation of the LCD modules resulting from caused by static electricity, etc. exercise care to avoid holding the following sections when handling the modules :
  - Exposed area of the printed circuit board
  - Terminal electrode sections