

## 2 MANGANESE DIOXIDE LITHIUM BATTERIES (CR SERIES FOR CONSUMER)

### CR-2

#### DIMENSIONS (MM)

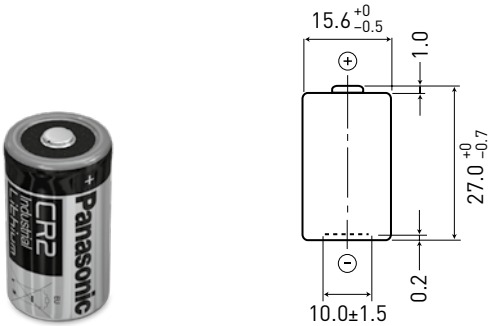

Model number	CR-2
Nominal voltage (V)	3
Nominal capacity (mAh)	850
Diameter (mm)	15.6
Total height (mm)	27.0
Discharging temperature range (°C)	-40 to +70*1
Weight (g)	11.0

#### DISCHARGE TEMPERATURE CHARACTERISTICS

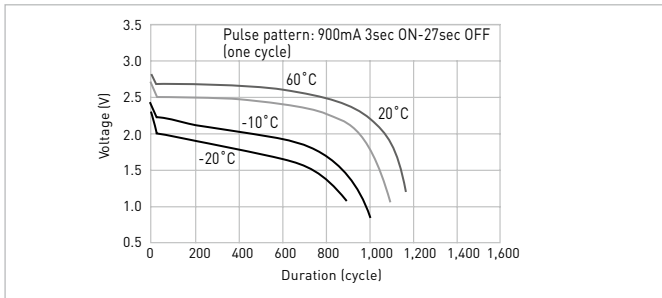

### CR-123A

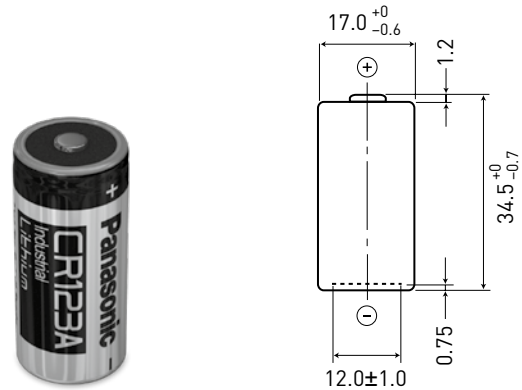

Model number	CR-123A
Nominal voltage (V)	3
Nominal capacity (mAh)	1,550
Diameter (mm)	17.0
Total height (mm)	34.5
Discharging temperature range (°C)	-40 to +70*1
Weight (g)	16.0

#### DISCHARGE TEMPERATURE CHARACTERISTICS

