

GAME & SURVEILLANCE CAMERA

GB

INSTRUCTION MANUAL

SNAPSHOT
CLOUD 4G

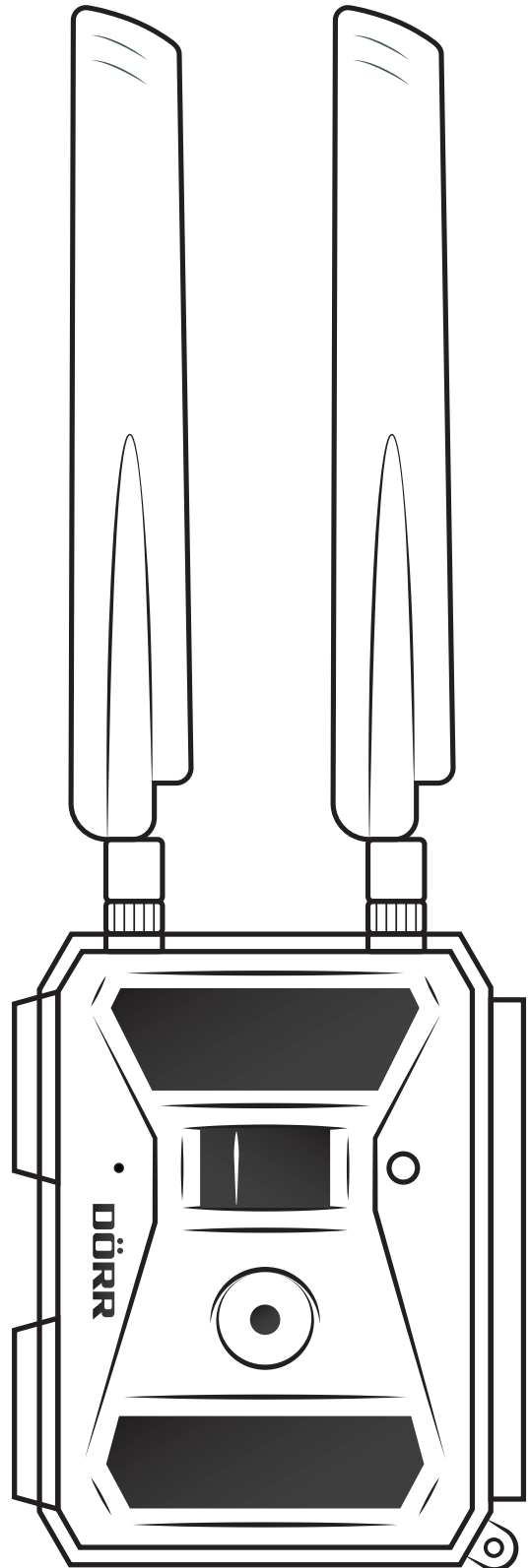

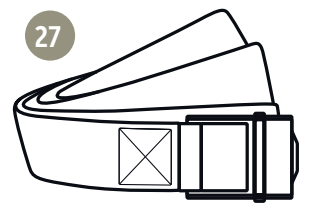
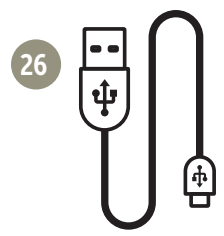
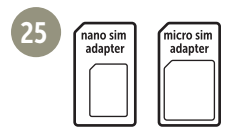
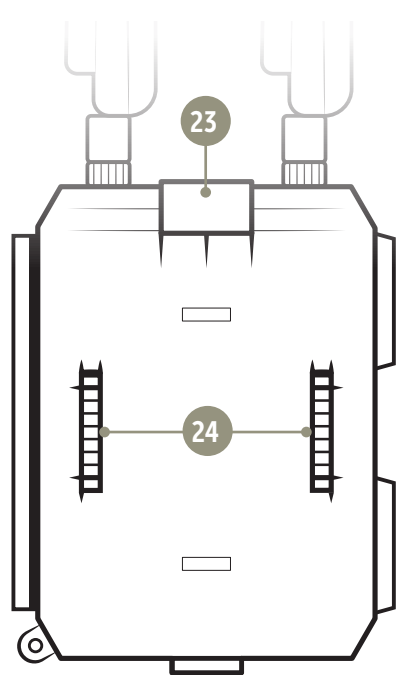
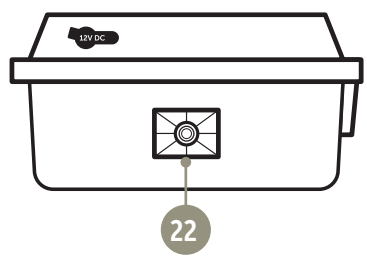
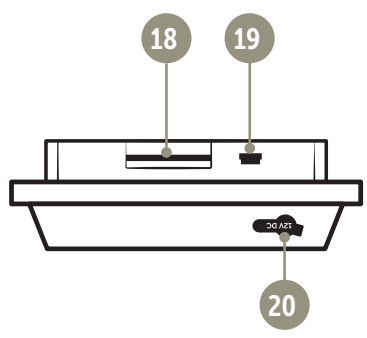
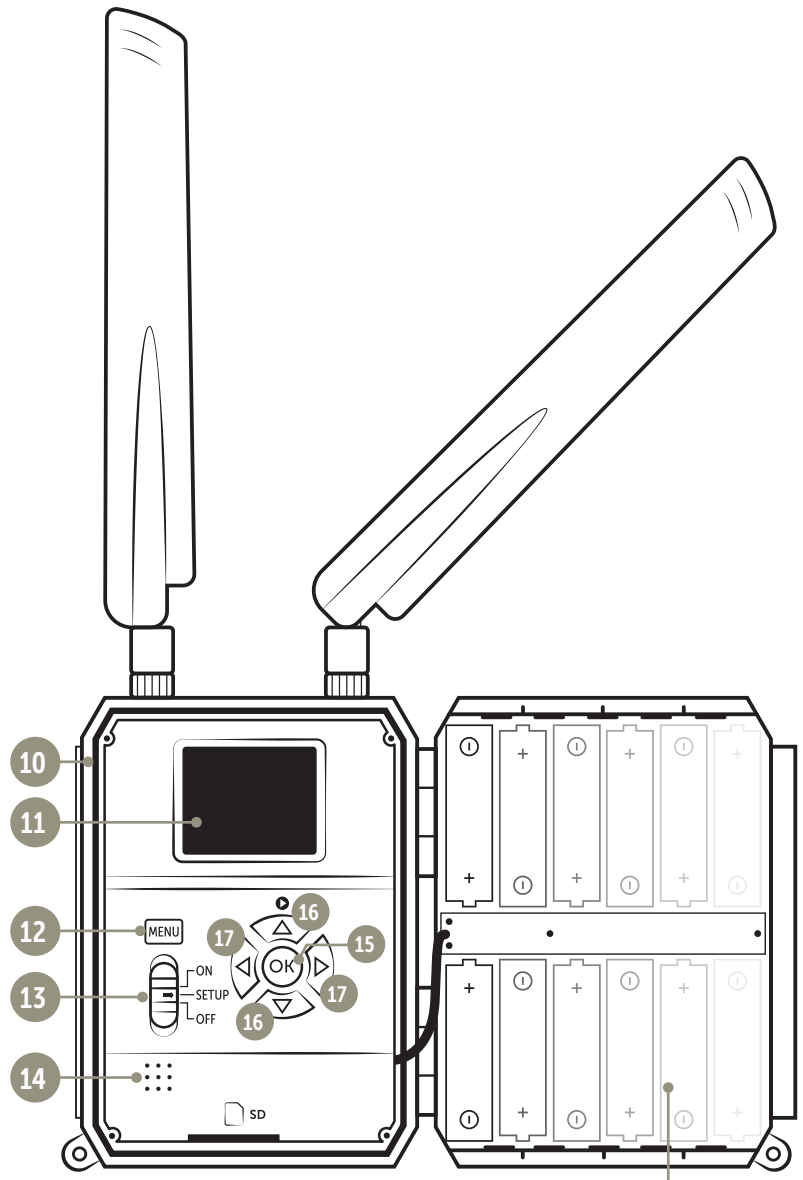
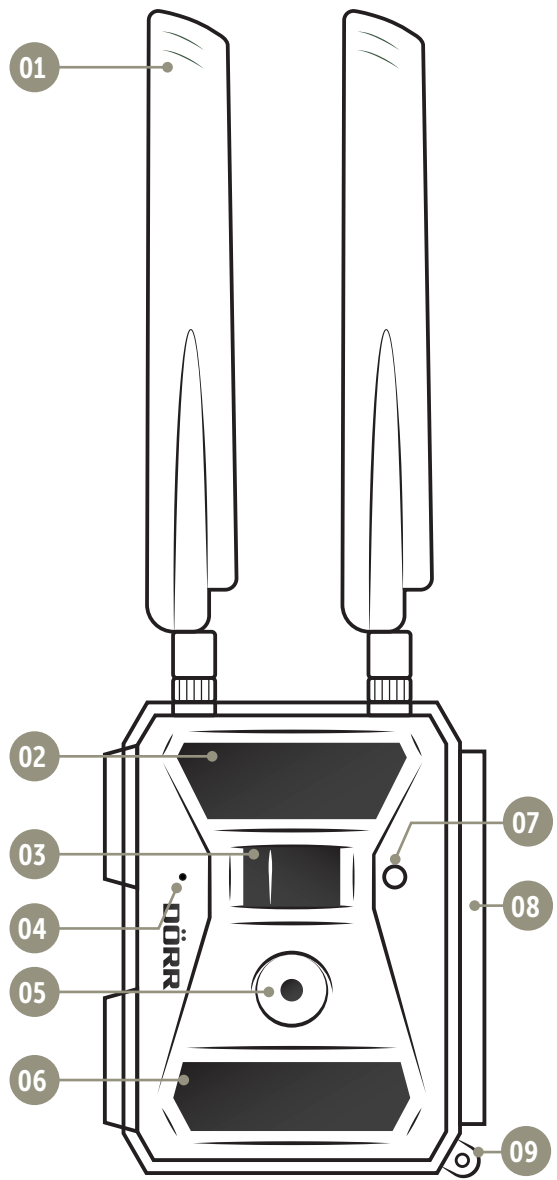

TABLE OF CONTENTS

- 01 | SAFETY HINTS**
- 02 | SAFETY HINTS FOR BATTERIES/ACCUMULATORS**
- 03 | PRIVACY POLICY**
- 04 | MOBILE PHONE COSTS FOR PICTURE TRANSMISSION**
- 05 | PRODUCT DESCRIPTION**
- 06 | FEATURES**
- 07 | NOMENCLATURE**
- 08 | FIRST COMMISSIONING**
 - 08.1 Mounting the antennas
 - 08.2 Inserting the batteries/rechargeable batteries
 - 08.3 Alternative power supplies
 - 08.4 Inserting the SD/SDHC memory card
 - 08.5 Unlocking SD card
 - 08.6 Inserting the SIM card
- 09 | USING THE CONTROL BUTTONS**
- 10 | CAMERA DISPLAY SYMBOLS**
- 11 | INITIAL SETUP/CONNECTING CAMERA WITH THE DÖRR APP**
 - 11.1 Set date/time
 - 11.2 Generating the QR code in the camera
 - 11.3 Downloading the DÖRR APP
 - 11.4 Registration in the DÖRR APP and connecting camera
 - 11.5 APP settings
- 12 | APP FUNCTIONS**
- 13 | DÖRR SNAPSHOT CLOUD 4G HOMEPAGE**
- 14 | SUBSCRIPTION FOR MORE STORAGE AND FULL HD QUALITY**
- 15 | DELETE/RE-REGISTERING A CAMERA/THEFT**
 - 15.1 Delete/Re-registering a camera
 - 15.2 In case of theft
- 16 | CAMERA OPERATION (OFFLINE WITHOUT SIM CARD)**
 - 16.1 Camera register CAM
 - 16.2 Camera register PIR
 - 16.3 Camera register 4G
 - 16.4 Camera register Other
 - 16.5 Viewing images and videos on the screen
 - 16.6 Delete images + format SD card
- 17 | ORIENTATION OF THE CAMERA/TEST PHOTO/MOUNTING THE CAMERA**
 - 17.1 Orientation of the camera/test photo
 - 17.2 Mounting the camera
 - 17.3 Secure camera from theft
 - 17.4 Notes for mounting the camera
 - 17.5 Turning camera on
- 18 | CLEANING AND STORAGE**
- 19 | TECHNICAL SPECIFICATIONS**
- 20 | SCOPE OF DELIVERY**
- 21 | DISPOSAL, CE MARKING, SIMPLIFIED EU DECLARATION OF CONFORMITY**
 - 21.1 Disposal of batteries/accumulators
 - 21.2 WEEE information
 - 21.3 ROHS conformity
 - 21.4 CE marking
 - 21.5 Simplified EU declaration of conformity



THANK YOU for choosing this DÖRR quality product.

Please read the instruction manual and safety hints carefully before first use.

Keep this instruction manual together with the device for future use. If other people use this device, make this instruction manual available. This instruction manual is part of the device and must be supplied with the device in case of sale.

DÖRR is not liable for damages caused by improper use or the failure to observe the instruction manual and safety hints.

01 | ⚠ SAFETY HINTS

- Your camera is fitted with a weatherproof housing according to protection class IP66 (dust and jet waterproof). So, the camera can be used outdoors. Nevertheless, protect the camera from extreme weather conditions and direct sunlight.
- Caution! Make sure to use only fresh Mignon AA LR 6 1.5 V Alkaline Manganese batteries or rechargeable NiMH batteries of the same type and brand. Never mix Alkaline Manganese batteries with NiMH batteries! When inserting the batteries please respect the correct polarity (+/-). Please remove batteries when device is not in use for a longer period.
- Do not drop the camera onto a hard surface. Do not use the camera if it has been dropped. In this case a qualified electrician should inspect the camera before you use it again.
- Do not attempt to repair the device by yourself. Risk of electrical shock! When service or repair is required, contact qualified service personnel.
- Do not open the camera housing (except the housing lid and the battery compartment) – the warranty will become void. The housing may only be opened by qualified DÖRR GmbH staff.
- People with physical or cognitive disabilities should use the camera with supervision.
- People with cardiac pacemakers, defibrillators or any other electrical implants should maintain a minimum distance of 30 cm, as the device generates magnetic fields.
- Do not use the camera nearby devices that generate strong electromagnetic fields.
- LED bulbs can only be replaced by qualified DÖRR GmbH staff.
- Avoid touching the camera lens with your fingers.
- Protect the camera against extensive dirt. Never use aggressive cleansing agents or benzine to clean the camera. We recommend a soft, slightly damp microfiber cloth to clean the outer parts of the camera and the camera lens. Make sure to remove batteries before cleaning.
- Store the camera in a dust-free, dry and cool place when not in use.
- This device is not a toy. To prevent accidents and suffocation keep the device, the accessories and the packing materials away from children and pets.
- If the device is defective or without any further use, dispose of the device according to the Waste Electrical and Electronic Equipment Directive WEEE. For further information, please contact your local authorities.

02 | ⚠ SAFETY HINTS FOR BATTERIES/ACCUMULATORS

Only use high-quality batteries/accumulators of popular brands. When inserting the batteries/ accumulators, please respect the correct polarity (+/-). Do not insert batteries of different types and always replace all batteries at the same time. Do not combine used batteries with fresh batteries. Please remove batteries/accumulators when device is not in use for a long period of time. Do not throw the batteries/accumulators into fire, do not short-circuit and do not disassemble them! Never charge non-rechargeable batteries – risk of explosion! Remove empty batteries immediately from the device to avoid the leaking of battery acid. Remove leaking batteries from the device immediately. Clean the contacts before inserting fresh batteries. Risk of battery acid burn! In case of contact with battery acid, rinse the affected area immediately with water and contact a doctor. Batteries can be dangerous to life if swallowed. Keep batteries/accumulators away from small children and pets. Do not dispose of batteries in household waste (see also chapter "Disposal of Batteries/Accumulators").

03 | PRIVACY POLICY

In every country, legal data protection rules apply. As these rules may vary per country, please contact the appropriate authorities to learn about the latest privacy policy in your country. In any case kindly note:

- Do not observe public areas such as sidewalks, roads, parking lots etc.
- Never observe your staff.
- Respect the general right of privacy.
- Do not publish pictures showing individuals without having their permission.
Do not publish pictures showing identifiable automobile license plates.
- Make aware of the observed areas with a sign and inform your neighbours and visitors if necessary.

04 | MOBILE PHONE COSTS FOR PICTURE TRANSMISSION

Data exchange via mobile transmission always cause extra costs. These costs may vary depending on your provider and selected tariff and are not covered by the purchase of this camera. Please contact your mobile phone provider for tariff and costs.

05 | PRODUCT DESCRIPTION

The **DÖRR SnapShot CLOUD 4G** especially meets the requirements of surveillance. Use it versatily during day and night time. With the **fast 4G LTE connection** recorded **pictures** are sent **directly to the cloud**. Access the Cloud worldwide with the **DÖRR APP** or over our website. The **extreme fast trigger speed** of the SnapShot Cloud 4G is only **0,4 seconds**. With its **12 Megapixel resolution** every detail is recorded. **57 invisible black vision LEDs** ensure inconspicuous surveillance. The **flash range** is about **20 meters** at a picture angle of about **50°**.

06 | FEATURES

- Picture or video recording, time lapse function
- Trigger speed only about 0,4 s
- Resolution 12 MP, 8 MP (Sensor 5 MP)
- Supports SD/SDHC memory cards from 4 GB up to max. 32 GB (SD card not included)
- TFT colour display with 2 inch / 5 cm size
- Multilingual camera menu
- Weatherproof housing protected according to IP66

07 | NOMENCLATURE

- 01 Antennas/antenna connections
- 02 27 infrared LEDs
- 03 Motion detector (PIR sensor)
- 04 Microphone
- 05 Camera lens
- 06 30 infrared LEDs
- 07 LED indicator/light sensor
- 08 Tension lock
- 09 Eyelet for U-lock (lock optional)
- 10 Mini-SIM card slot
- 11 LCD camera display
- 12 MENU button
- 13 Slide control (ON/Setup/OFF)
- 14 Speaker
- 15 OK button
- 16 Navigation buttons ▼ and ▲ (also Playback button ►)
- 17 Navigation buttons ◀ and ▶
- 18 SD card slot
- 19 Mini USB port
- 20 Connection external battery
- 21 Battery compartment
- 22 ¼" thread mount
- 23 Eyelet for cable lock (lock optional)
- 24 Eyelets for mounting strap
- 25 Micro-SIM + Nano-SIM adapter
- 26 USB data cable
- 27 Mounting strap

08 | FIRST COMMISSIONING

Remove the protective foil from the LCD camera display (11).

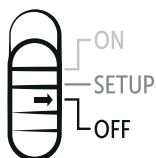

⚠ CAUTION: To avoid camera damages make sure that camera is switched off (slide control 13 = OFF) for the following steps!

08.1 MOUNTING THE ANTENNAS

Remove the protective caps from the antenna connections (01) and screw on the two supplied antennas.

08.2 INSERTING THE BATTERIES/RECHARGEABLE BATTERIES

Open the tension lock (08). **Make sure that slide control (13) is on position OFF.** Insert **12 pcs AA 1,5 V batteries or rechargeable NiMH batteries** (optional) into the battery compartment (21). **Respect correct polarity (+/-).**

⚠ CAUTION: Make sure to use only fresh Mignon AA LR 6 1.5 V Alkaline Manganese batteries or rechargeable NiMH batteries of the same type and brand. **Never mix Alkaline Manganese batteries with NiMH batteries!** When inserting the batteries please respect the correct polarity (+/-). Please remove batteries when device is not in use for a longer period.

NOTE To ensure exact indication of battery status when operating the camera with **NiMH rechargeable batteries**, please select **NiMH** in the camera menu "Battery Type" located in camera register "Other" – please refer to chapter 16.4.

08.3 ALTERNATIVE POWER SUPPLIES

Use the **DÖRR solar panel** with internal Lithium Ion battery 1500 mAh for a sustainable and extended runtime:

Item No. 204442 DÖRR Solar Panel SP-1500 12 V

For indoor surveillance near power outlet, the camera can be operated via AC power supply:

Item No. 204441 DÖRR AC adapter 12 V, 2 A for SnapShot Cloud 4G

Alternatively, the camera can be operated with an **external 12 V battery** in conjunction with our **DÖRR battery cable**:

Item No. 204347 SLA Battery 12 V/12 Ah for SnapShot 4G

Item No. 204363 DÖRR Battery Cable for Snapshot Cameras 2 m with flat plug Faston F1 No. 187/4,8 mm

The solar panel, the AC adapter and the 12 V battery need to be plugged-in to the cameras DC 12 V connection (20). Any inserted batteries do not need to be removed when using external power supplies. The camera automatically reverts to the inserted batteries as soon as the external power supply is disconnected.

08.4 INSERTING THE SD/SDHC MEMORY CARD

Insert a **SD/SDHC memory card** (optional) with the label facing upwards into the SD card slot (18) until it snaps into place. **Make sure that the SD card is formatted and unlocked.** The camera supports **SD/SDHC cards from 4 GB to 32 GB**. To format the SD card with the camera, please read chapter 16.6.

08.5 UNLOCKING SD CARD

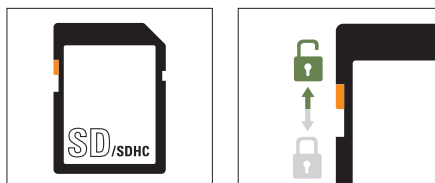

08.6 INSERTING THE SIM CARD

In order to use the mobile transmission function, make sure to **insert a SIM card** (optional) into the SIM card slot (10). Please mind the symbol above the SIM card slot which shows how to insert the card correctly. The SIM card slot is fitted for **Mini SIM** cards. **Micro-SIM cards and Nano-SIM cards** can be used with the **supplied adaptors** (25) only.

The **PIN request has to be deactivated, you can do this directly in the shop where you bought the SIM card, or with help of a mobile phone.** Make sure the SIM card is **activated for the mobile data transmission** and if has **sufficient credit**.

For the mobile data transmission, the camera needs the parameter data of the respective provider.

In general, the camera receives the provider data **automatically**. In some specific cases you must enter these data in the menu of the camera. **How to enter these data please read chapter 16.3.**

HINT To ensure a proper mobile transmission we recommend the use of the **simHERO SIM card which works independently from any specific network provider with cheap DÖRR plans (Item-No. 204445).**

As soon as a SIM card is installed and the slide control (18) is on position ON or SETUP the camera searches for network reception. This may take **up to 1 minute**. In SETUP mode no settings can be made in camera menu during network search. **After successful connection, the LCD display (11) will show signal strength.**

09 | USING THE CONTROL BUTTONS

The **slide control** (13) has 3 positions: **ON** turns the camera on, position **OFF** means turning off the camera. Choose **SETUP** position and press MENU button (12) to enter the camera menu.

Use the **navigation buttons** ◀ and ▶ (17) to browse through the following registers:

Cam	PIR	4G	Other
Settings (read chapter 16.1)	Settings (read chapter 16.2)	Settings (read chapter 16.3)	Settings (read chapter 16.4)

The selected camera register will be **highlighted in red with a white background**. To **open the selected register**, press the **OK button** (15).

Use navigation buttons ▼ and ▲ (16) and select the **submenu** you want to change. The selected submenu will be **highlighted in red**. Press OK button (15) to **open** the submenu.

Use **navigation buttons (16) and (17)** and **change the settings**. Press **OK button** (15) to save the setting. Press **MENU button** (12) to return to the main screen with the real-time image.

10 | CAMERA DISPLAY SYMBOLS

Camera Mode	Image resolution	Photo(s) per release	Signal strength	Remaining storage capacity of SD card	Battery Status
	12M	1P		0000/0000	
Camera Mode	Image resolution	Video resolution	Signal strength	Remaining storage capacity of SD card	Battery Status
	12M			0000/0000	

11 | INITIAL SETUP/CONNECTING CAMERA WITH THE DÖRR APP

11.1 SET DATE/TIME

⚠ CAUTION: The camera usually overtakes the date and time from the network. To ensure proper camera function, it is necessary to check the date and time and set the UTC time difference:

Switch the slide control (13) to SETUP. Wait until "Searching..." is finished.

Press and hold navigation button ▶ (17) - the display shows date, time and the name of the sim card provider.

When date is shown correctly in the display, you only have to set the **current UTC time** of your region within the submenu **"Auto"**:

Press MENU button (12). Switch to camera register **"Other"** with navigation button ▶ (17). Press the OK button (15) to enter the submenu. With navigation button ▼ (16) select the submenu **"Date/Time"**. Press OK button (15) to open the submenu **"Auto"**. Enter the **UTC time zone** as follows: +/- HH:MM.

Example Germany:

Winter time UTC +01:00
Summer time UTC +02:00

If the date is not shown correctly, enter the date and time manually in the submenu **"Manual"** as follows: DD/MM/YYYY HH:MM:SS.

Turn the slide control (13) to position OFF.

11.2 GENERATING THE QR CODE IN THE CAMERA

Switch the slide control (13) to SETUP. Press MENU button (12). Switch to camera register **"Other"** with navigation button ▶ (17). Press the OK button (15) to enter the submenu. With navigation button ▼ (16) select the submenu **"QR Code"**. Press OK button (15) to generate the QR code which will be shown in the camera display (11).

11.3 DOWNLOADING THE DÖRR APP



To install the **DÖRR APP**, scan the corresponding **QR code for Android or iOS from the inside of the colour box** with your smartphone or download directly in the Play Store for Android or in the APP store for iOS.

11.4 REGISTRATION IN THE DÖRR APP AND CONNECTING CAMERA

Register with your **email address and a password**. You will receive a confirmation email from DÖRR to the registered email address. **Follow the link** in this email for successful registration. **Log in with the data used for registration**.

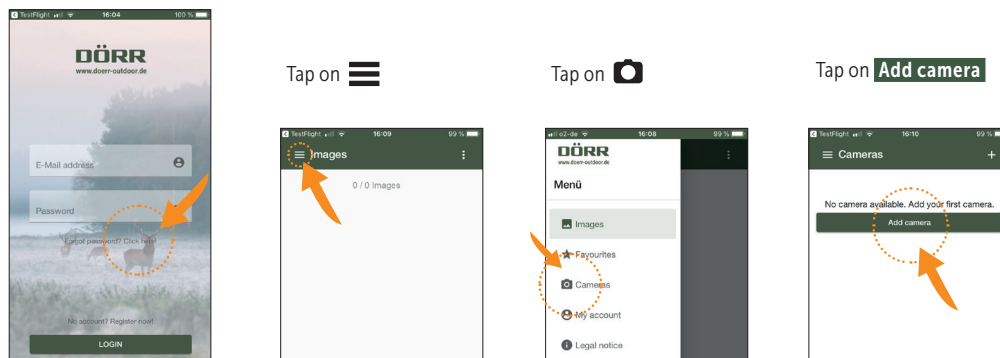

The QR code scanner will start. Use your Smartphone to scan the QR code in the camera display (11).



Alternatively, you can enter the **serial number** manually. You will find the serial number inside on the **left side of camera housing** or directly on the colour box.

Please switch the slide control (13) to position **ON** and close the tension lock (08).

Please enter the following data in the APP:

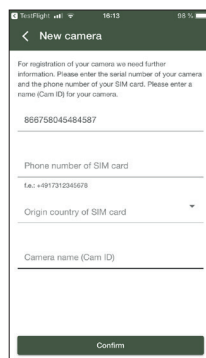

Serial number of camera
Copies automatically when scanning the QR code.

Phone number of SIM card
Enter the telephone number including country code of inserted SIM card.

Origin country of SIM card
Set automatically with country code.

Camera name (Cam ID)
Please enter a name for the camera.

Tap on **Confirm**

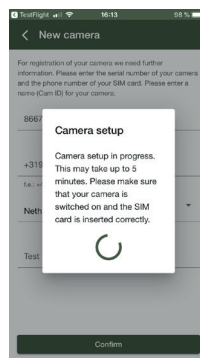







The camera will connect to the APP. Camera will be configured online – **this may take some minutes**.

CAUTION: Please make sure your camera is switched on and that the SIM card is inserted correctly.

After successful initial setup you may change the following settings inside the APP (default value is marked in green):

11.5 APP SETTINGS

CAMERA		
Choose the camera mode :		
	Photo	The camera will record photos according to the settings image size + Multi shot.
Camera mode	Photo & Video	The camera will record a picture(s) followed up by a video according to the settings Image Size + Multi-Shot + Video Size + Video Length. Videos will not be sent to the Cloud. The video will be saved onto the SD card . When a new video was recorded, you will receive a new picture into your gallery.
	ON 	When SD card is full, the camera will overwrite oldest pictures with new ones.
SD-card overwrite	OFF 	When SD card is full, the camera will go to standby mode until the SD card is changed or formatted.
Origin country of SIM card	(according to your registration)	
Phone number of SIM card	(according to your registration)	
Camera Name	(according to your registration)	
PHOTO		
Set desired photo resolution :		
	12M	12 MP (4032x3024)
Image size	8M	8 MP (3264x2448)
	5M	5 MP (2560x1920)
	1 Pic	Set the number of pictures that are shot upon motion/triggering . Choose from 1 up to 5 images in a row.
Multi shot	2 Pics	
	3 Pics	
	4 Pics	
	5 Pics	
Set from 00:00:05 to 23:59:59		
	ON 	The camera triggers according to the specific time set . This happens independently from the PIR detector. <u>Example: 01:00:00</u> The camera triggers every hour independently from motion recognition. When PIR sensor function is set ON as well, the camera triggers additionally on motion. When PIR detector is off, camera only triggers in set time.
Time lapse	OFF 	When Time lapse is set OFF, the camera triggers only upon motion recognition and temperature change with the specific delay set.
Set from 00:00:03 to 23:59:59		
	ON 	Choose ON to set a pause for the PIR Sensor . During this pause no images are triggered upon motion detection and temperature changes. This setting prevents the camera from taking too many images/videos. <u>Example: 00:01:00:</u> After triggering, the camera sets the PIR inactive for 1 minute. After the time set the PIR sensor will be active again.
Delay	OFF 	Camera only triggers according to the setting made in Time lapse.
FLASH LED SETTINGS		
Set the desired flash range :		
	All – max. flash	All 57 IR LEDs work during darkness (Flash range up to 20 m)
Flash LED	Part – min. flash	Only the upper 27 IR LEDs work (Flash range up to 8 m)
Set the quality of the night images :		
	Max. Range	Longer exposure time to extend IR flash range for better night vision.
Night mode	Balanced	Intelligent auto night mode
	Min. Blur	Short exposure time to minimize motion blur for better image quality; shorter IR flash range.

PIR MOTION DETECTOR

PIR switch On/Off	<input checked="" type="checkbox"/> ON	The Passive Infrared Sensor (PIR) triggers upon motion and temperature changes recognised within the detection range.
	<input type="checkbox"/> OFF	⚠ CAUTION: Camera will not work on motion. Mind to set Time Lapse function ON!
Set the PIR sensitivity:		
Sensitivity	High	(Recommended): the camera recognises even smallest motion and temperature change. Max. detection range.
	Middle	Set Low when camera triggers too often upon environment influences, e.g. falling branches or strong sunlight, smaller detection range.
	Low	

VIDEO SETTINGS (only shown when camera mode is set to Photo and Video)

Video size	FHD-1080P	FHD 1080P (1920x1080)
	HD-720P	HD720P (1280x720)
	WVGA	WVGA (848x480)
Video length	05 - 59	Set the desired video length from 5 up to 59 seconds.

TIMER

Set start and end of the **working time 1**

Timer 1	<input checked="" type="checkbox"/> ON	Outside of this time frame the camera will be in standby mode . Example: 14:00 – 17:00: camera is active from 2 pm until 5 pm.
	HH : MM	Set start time (24-hour-format)
	HH : MM	Set end time (24-hour-format)
	<input type="checkbox"/> OFF	The camera will work 24 hours

Timer 2	<input checked="" type="checkbox"/> ON	Set start and end of the working time 2 (see Timer 1).
	HH : MM	Set start time (24-hour-format)
	HH : MM	Set end time (24-hour-format)
	<input type="checkbox"/> OFF	The camera will work 24 hours or according to Timer 1.

CONFIRM SETTINGS

NOTE

During the *initial setup* the camera will apply and accept settings immediately. Settings changed in *ongoing operation* will *synchronised with a time delay of up to 24 hours*. *APP settings have priority and overwrite settings made directly within the camera menu*. *Change your camera settings always with help of the APP or our website.*

The camera is now ready to work according to your settings. In APP menu "Images" you will see all recorded images.

Notes for mounting and orientation of the camera please read chapter 17.

12 | APP FUNCTIONS

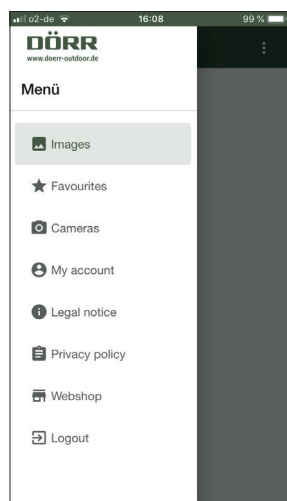

MENU

Images



Gallery of all images made.
 Use the filter function to search specific images.

Add image to favourites/save/share/delete



Touch the desired image. To add the image to your **favourites**, tap **★** (to deselect, tap star again ☆). Tap **➔** to save or share the image e.g. by WhatsApp or Email. Confirm **Delete** to erase the image.



Favourites

Gallery of all images added to favourites.
 Use the filter function to search specific images.

Cameras

Shows all registered cameras. Select desired camera for more information and settings: 

Information	Firmware	Shows current firmware version. For firmware update tap on  and follow the instructions in the APP.
	Battery	Shows current battery status
	Next synchronisation	Shows date and time of the next synchronisation
	Synchronised	<input checked="" type="checkbox"/> successfully synchronised
 Settings	Camera Settings	> Camera Settings (see chapter 11.5).
	Push	<input checked="" type="checkbox"/> Allow Push notifications

 Share	Friends	> Share images of the selected camera with friends and colleagues within the DÖRR APP (registration is necessary) . Tap + and enter the email of your friend. Tap Invite . Your friend receives an email invitation to register for our service. After successful registering, your friend is able to see the images of the shared camera. To end sharing the images, tap the email address and confirm Delete .
	E-Mail	> Share images of the selected camera with friends and colleagues by email (no registration required) . Tap + and enter the contact data. Tap  to import data from your contacts. To end sharing the images, tap the email address and confirm Delete .

User Shows/changes the account data

My account

Overview subscriptions Shows status of image quality and storage subscriptions.
PLEASE MIND: There is no service within the APP to buy or end subscriptions. Please visit camera.doerr-outdoor.de if you want to purchase more storage for your images or you want to receive images in Full HD quality.

Legal notice

Privacy policy

Webshop

Visit our webshop for a **huge selection of game and surveillance camera accessories** and discover our big range of **hunting and outdoor equipment!** www.doerr-outdoor.de/en-us/

Logout

13 | DÖRR SNAPSHOT CLOUD 4G HOMEPAGE

You may also register or login by PC/Laptop/Tablet on our homepage: camera.doerr-outdoor.de. We recommend using **Google Chrome Browser** . You will find all the functions as in the APP described above.

14 | SUBSCRIPTION FOR MORE STORAGE AND FULL HD QUALITY

Per registered camera the basic contingent is **1000 images in standard quality, as well as 200 favourite images**. Under  **My account** you can subscribe for **more storage contingent and images in Full HD quality**.



NOTE An active subscription will apply for all your registered cameras! Subscriptions may be cancelled on monthly basis.

⚠ CAUTION: Purchase the subscriptions on our homepage: camera.doerr-outdoor.de

15 | DELETE/RE-REGISTERING A CAMERA/THEFT

15.1 DELETE/RE-REGISTERING A CAMERA

In case you want to sell your camera, please follow these steps:

1. Delete the camera in the APP:  **Cameras** → **touch the camera to delete**  → **Delete camera**
2. Reset camera to factory default (see chapter 16.4). After successful above steps, the camera may be registered from you or the new owner.

15.2 IN CASE OF THEFT

In case the camera gets stolen, do **NOT delete** it from the DÖRR APP, because it may not be registered twice. **Contact our service department for further support.**

16 | CAMERA OPERATION (OFFLINE WITHOUT SIM CARD)

If you want to use the camera without SIM card, do all settings directly in the camera. Images and videos are saved onto the SD card.

16.1 CAMERA REGISTER CAM

(Default value is marked in green)

Enter a **name for the camera**. Use up to **12 numbers and/or letters (1-9; A-Z)**.

Cam ID	ON 000000000000	The camera name will be shown on each image – recommended when using more than one camera.
	OFF	(without camera name)
Choose the camera mode :		
Cam Mode	Photo	The camera will record images according to the settings Image Size + Multi-Shot.
	Pic + Video	The camera will record a picture(s) followed up by a video according to the settings Image Size + Multi-Shot + Video Size + Video Length.
Set the desired flash range:		
Flash LED	All	All 57 IR LEDs work during darkness (Flash range up to 20 m)
	Part	Only the upper 27 IR LEDs work (Flash range up to 8 m)
Set desired image resolution :		
Image Size	12M	12 MP (4032x3024)
	8M	8 MP (3264x2448)
	5M	5 MP (2560x1920)
Set the quality of the night images :		
Night mode	Max. Range	Longer exposure time to extend IR flash range for better night vision.
	Balanced	Intelligent auto night mode
	Min. Blur	Short exposure time to minimize motion blur for better image quality; shorter IR flash range.
Multi-Shot	1 P	Set the number of pictures that are shot upon motion/triggering . Choose from 1 up to 5 images in a row.
	2 P	
	3 P	
	4 P	
	5 P	
Set the desired video resolution :		
Video Size	FHD-1080P	FHD 1080P (1920x1080)
	HD-720P	HD720P (1280x720)
	WVGA	WVGA (848x480)
Video Length	05 - 59	Set the desired video length from 5 up to 59 seconds.

16.2 CAMERA REGISTER PIR

(Default value is marked in green)

Turn on or off the PIR sensor:

PIR Switch	OFF	⚠ CAUTION: Camera will not work on motion. Mind to set Time Lapse function ON!
	ON	The Passive Infrared Sensor (PIR) triggers upon motion and temperature changes recognised within the detection range.
Set the PIR sensitivity	High	(Recommended): The camera recognises even smallest motion and temperature change. Max. detection range.
	Middle	Set when camera triggers too often upon environment influences, e.g. falling branches or strong sunlight, smaller detection range.
Sensitivity	Low	
Delay	OFF	Choose ON to set a pause for the PIR Sensor . During this pause no images are triggered upon motion detection and temperature changes. This setting prevents the camera from taking too many images/videos. Example 00:01:00 .
	ON 00:00:03 – 23:59:59	After triggering, the camera sets the PIR inactive for 1 minute. After the time set the PIR sensor will be active again.
Time Lapse	OFF	The camera triggers according to the specific time set. This happens independently from the PIR detector . Example 01:00:00 .
	ON 00:00:05 – 23:59:59	The camera triggers every hour independently from motion detection. When PIR sensor is set ON as well, the camera triggers additionally on motion and temperature change. When PIR sensor is set OFF, the camera triggers only to the time set in Time Lapse menu.
Timer 1	OFF	The camera will work 24 hours.
	ON 00:00 – 00:00	Set start and end of the working time 1 . Outside of this time frame the camera will be in standby mode . Example 14:00 – 17:00: camera is active from 2 pm until 5 pm .
Timer 2	OFF	The camera will work 24 hours or according to Timer 1.
	ON 00:00 – 00:00	Set a second time frame in between the camera is active (see Timer 1).

16.3 CAMERA REGISTER 4G

(Default value is marked in green)

	Auto		
SIM Auto Match	Manual	APN:	Enter the APN (Access Point Name) of your SIM card
		User Name:	Enter User Name of the APN
		Password:	Enter Password of the APN

NOTE For Data like APN, User Name and Password please contact your telephone provider.

Enter the data as follows:

Press MENU button (12) to switch between **numbers, upper- and lower-case letters as well as special characters**. Use the navigation buttons (16 + 17) to select the desired character (highlighted in red). Confirm the character by pressing the OK button (15). Select character < (marked in red) and confirm with OK button (15) to delete the last character. When the input is complete and correct select character ^ (marked in red) and confirm with OK button (15) in order to save the input.

16.4 CAMERA REGISTER OTHER



(Default value is marked in green)

Language	German	
	English	
	French	
	Italian	Choose your desired menu language.
	Russian	
	Polish	
	Hungarian	
Czech		
Set date and time. NOTE We recommend setting date and time manually in offline mode to prevent from malfunction.		
Date/Time	Auto	
	Time Zone	Not available in offline mode. Please enter manually.
	UTC +/- 00:00	
	Manual	
	Date 00/00/0000	Set date and time manually.
	Time 00:00:00	
Set the date format out of the following options:		
Date Type	YY/MM/TT-(CN)	Year/Month/Day Example: 20/12/31
	MM/TT/YY-(US)	Month/Day/Year Example: 12/31/20
	TT/MM/YY(-EU)	Day/Month/Year Example: 31/12/20
Battery type	Alkaline	Choose whether you are using Alkaline batteries, or NiMH rechargeable batteries.
	Ni-MH	
Frequency	50Hz	Set the frame refresh rate of the LCD camera display (11).
	60Hz	
SD Cycle	OFF	When SD card is full, the camera will go in standby mode until the SD card is changed or formatted.
	ON	When SD card is full, the camera will overwrite oldest pictures with new ones.
Password	The camera may be protected from unauthorised user by setting a password . When password function is activated, the camera will ask for the password each time it is turned on. CAUTION We recommend writing the password down in a secure location. When the password is lost the camera will not work anymore.	
	OFF	Without password protection
	ON 000000	Enter a 6-digit code number.
Reset ?	NO	Reset camera to factory default. Please contact our DÖRR Service.
	YES	
Firmware Update	Only via DÖRR APP or Login: camera.doerr-outdoor.de	
QR Code	Camera generates QR Code for use with DÖRR APP	
About	Shows current software version and serial number (IMEI) of the camera. No change of setting possible within this menu.	

16.5 VIEWING IMAGES AND VIDEOS ON THE SCREEN

Slide the Switch (13) to position SETUP. Press playback button  (16).

The camera display (11) shows the latest recorded image. The camera display will show  when this file is a video. To start the playback, press OK button (15).

Use navigation buttons  and  (17) to browse through the complete gallery. Press playback button  (16) to return to the main screen.

16.6 DELETE IMAGES + FORMAT SD CARD

In order to delete an image or format SD card, press MENU button (12) while viewing an image. Choose "Del" and confirm to delete only **one** or **all** images. Choose "Format" to format the SD card.

 **CAUTION: All images on the SD card will be deleted irrevocably.**

Press MENU button (12) and the playback button  (16) to return to the main screen.

17 | ORIENTATION OF THE CAMERA/TEST PHOTO/MOUNTING THE CAMERA

17.1 ORIENTATION OF THE CAMERA/TEST PHOTO

We recommend placing the camera in a height of about **0,75 to 1,00 m**. The camera lens (05) should point where the expected object will appear.

To verify your camera is hung up in a correct angle, we recommend to take a **test photo**. Switch the slide control (13) to position SETUP and hold the camera in desired height and angle.

Press OK button (15) to trigger the test photo. To view the test photo press playback button  (16). Adjust the picture angle so that the expected object will appear in the centre. Repeat adjusting angle and height and take test photo until you are satisfied.

17.2 MOUNTING THE CAMERA

Pull the supplied mounting strap (27) through the eyelet (24) on the backside of the camera. Mount the camera to a tree, pole or any other suitable object.

Our optional accessories such as the **patented DÖRR holding fixture** allow fast and easy mounting of the camera to trees, walls or other objects. The camera snaps into the holding fixture and is firmly held in place. The camera can be removed easily for a quick change of location. The ball head with a fixing screw ensures a flexible direction of the camera. The fixture is rotatable by 360° and swivels up to 30° in all directions.

Item No 204490 **DÖRR Holding Fixture for SnapShot Multi camouflage**

17.3 SECURE CAMERA FROM THEFT

Pull a **U-lock** (optionally available) through the eyelet for U-lock (09) to lock the camera housing. Use a **cable lock** (available as accessory) and pull it through the eyelet for cable lock (23) on the backside of the camera to secure it against theft.

Item No. 204450 **MASTERLOCK cable lock Python camouflage**

Item No. 204451 **MASTERLOCK cable lock Python black**

For high safety we recommend our **powder-coated DÖRR metal housing** which protects the camera from theft, vandalism and extreme weather conditions.

Item No. 204463 **DÖRR Metal Housing GH-4 for SnapShot Cloud 4G**

Visit our web shop for a **great variety of surveillance camera accessories** and get more information on our wide assortment of **hunting and outdoor items!**

www.doerr-outdoor.de/en-us/

17.4 NOTES FOR MOUNTING THE CAMERA

PIR sensor

The PIR sensor triggers only under specific circumstances within a certain range. The capturing of objects strongly depends on temperature, vegetal cover, reflecting surfaces etc. Under perfect conditions the recognition range can be up to 20 m. Usually, you may expect a range of 15 m. It may take a few attempts to find a good position for the camera. During photo test, be aware that animals are usually remarkably smaller than human beings. Animals might be below the PIR sensor detection range and not be captured.

Light conditions

Avoid direct backlight when mounting the camera. The lens should not point directly into the sun and camera should not be placed in shadow.

Weather protection

Although the camera is weatherproof and well-suited for outdoor use (dust and jet water protected according to IP66 protection class) we recommend mounting the camera in a secured place not facing the weather exposed side. Prevent the camera from driving rain and constant exposure to sunlight. After a long period of humidity caused by rain or fog, the camera should be placed in a dry area for a few days.

17.5 TURNING CAMERA ON

In order to get the camera started switch the slide control (13) to position ON and close the camera housing. After about 10 sec. the camera is active and starts surveillance according to your settings.

18 | CLEANING AND STORAGE

Never use aggressive cleansing agents or benzine to clean the device. We recommend a soft, slightly damp microfiber cloth to clean the outer parts of the device. Make sure to remove the batteries before cleaning. Store the device in a dust-free, dry and cool place when not in use. This device is not a toy – keep it out of reach of children. Keep the device away from pets.

19 | TECHNICAL SPECIFICATIONS

Recording capability	Photo / Photo+Video with audio
Combined picture and video recording	yes
Number of LEDs	57 (27 top + 30 bottom)
LED Type	Invisible Black Vision Infrared LEDs, 940 nm
Flash range max. approx. [m]	20
Detection range motion sensor approx.	20 m / 50°
Picture angle approx.	52°
Trigger speed approx.	0,35-0,4 s
Image sensor	5 Mega Pixels Colour CMOS Sensor
Picture resolution [MP]	5 MP (2560x1920) / 8 MP interpolated (3264x2448) / 12 MP interpolated (4032x3024)
Video resolution	Full HD 1080 P (1920x1080) / HD 720 P (1280x720) / WVGA (848x480)
Video length	5-59 s
Digital picture format	JPEG
Digital video format	MOV
Mobile picture transmission	yes
Mobile video transmission	no
Picture playback	yes
Video playback	yes
Audio	yes
Lens	F=3.0/52°
Display	LCD TFT 2" (39x31 mm), RGB, 262 k
Multiple shots (pictures per release)	1-5
PIR Delay	3 seconds to 24 hours
Time frames per day	2
Time lapse	yes
Time stamp on image	Camera name, battery status, temperature (°F/°C), moon phase, date, time
Sensitivity PIR sensor	High, middle, low
Menu language	DE, GB, FR, IT, RU, PL, HU, CZ
Password protection	yes
Memory card	SD/SDHC 4 GB to max. 32 GB (optional)
SIM card format	Mini-SIM (Micro-SIM and Nano-SIM with adapter)
Mobile radio module	4 G LTE (down gradable)
Protection class	IP66
Thread mount 1/4"	yes
Compatible with Dörr Holding Fixture (Item No. 204490)	yes
Power consumption approx.	Operation by day approx. 170 mA, by night approx. 750 mA / Standby 0,21 mA
Runtime in standby mode approx.	up to 8 months with 12x AA batteries
Operating voltage	DC 12 V
Power supply	12x Mignon AA LR 6 1,5 V Alkaline batteries or rechargeable batteries NiMH AA
Power supply incl.	no
Socket for external battery	yes
Operating temperature approx. [°C]	-25 °C to +60 °C
Relative humidity approx. [%]	5% - 95%
Storage temperature approx. [°C]	-30 °C to +70 °C
Dimensions approx. [cm]	12 x 14,5 x 8 cm / height with antennas: 37 cm
Weight without batteries approx. [g]	464 g

Technical specifications are subject to change without notice.

20 | SCOPE OF DELIVERY

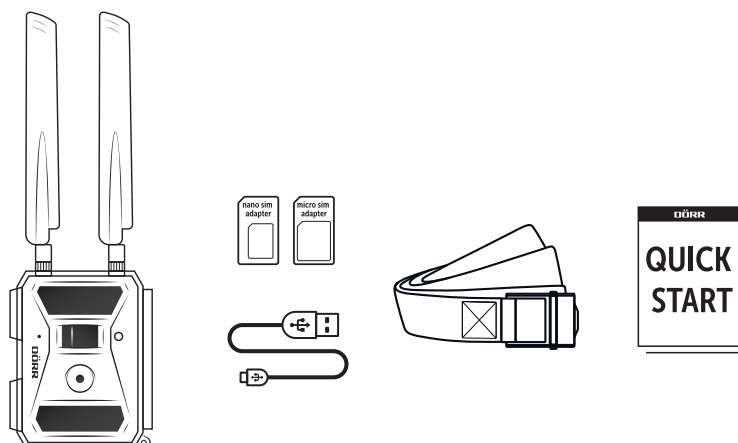

21 | DISPOSAL, CE MARKING, SIMPLIFIED EU DECLARATION OF CONFORMITY



21.1 DISPOSAL OF BATTERIES/ACCUMULATORS

Batteries are marked with the symbol of a crossed out bin. This symbol indicates that empty batteries or accumulators which can no longer be charged should not be disposed of with household waste. Waste batteries may contain harmful substances that can cause damage to health and to the environment. Please use the return and collection systems available in your country for the disposal of the waste batteries.



21.2 WEEE INFORMATION

The Waste Electrical and Electronic Equipment Directive (WEEE Directive) is the European community directive on waste electrical and electronic equipment, which became European law in February 2003. The main purpose of this directive is to prevent electronic waste. Recycling and other forms of waste recovery should be encouraged to reduce waste. The symbol (trash can) on the product and on the packing means that used electrical and electronic products should not be disposed of with general household waste. It is your responsibility to dispose of all your electronic or electrical waste at designated collection points. Disposing of this product correctly will help to save valuable resources and it is a significant contribution to protect our environment as well as human health. For more information about the correct disposal of electrical and electronic equipment, recycling and collection points please contact your local authorities, waste management companies, your retailer or the manufacturer of this device.

21.3 ROHS CONFORMITY

This product is compliant with the European RoHS directive for the restriction of use of certain hazardous substances in electrical and electronic equipment and its amendments.



21.4 CE MARKING

The CE marking complies with the European standards and indicates that the product meets the requirements of the applicable EU directives.

21.5 SIMPLIFIED EU DECLARATION OF CONFORMITY

Hereby, DÖRR GmbH declares that the radio equipment type [204440] is in compliance with Directive 2014/53/EU. The full text of the EU declaration of conformity is available at the following internet address: <http://www.doerr-outdoor.de>

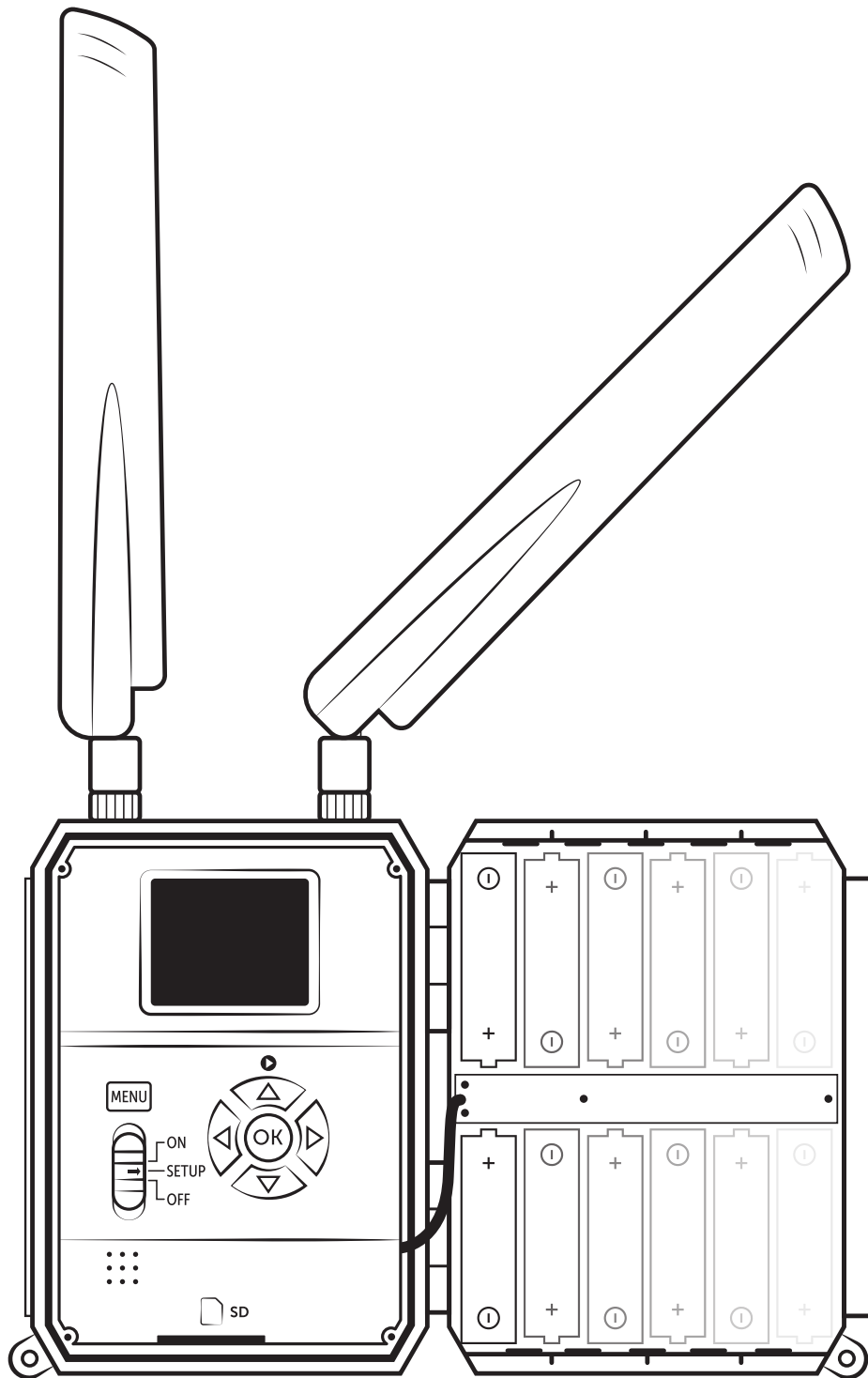

GAME & SURVEILLANCE CAMERA SNAPSHOT CLOUD 4G

Item No 204440