

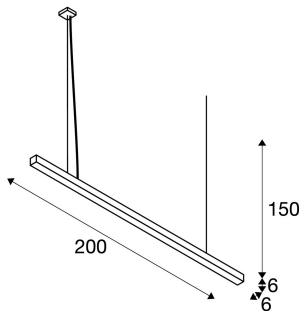

Q-LINE PD

LED Indoor pendant light, 2m, BAP, black, 4000K

The Q-LINE ceiling light is optionally available with a white, black, or silver-grey luminaire housing. It is also available with a pure white or warm white LED, and different dimensions. Its high luminance and UGR value of less than 10 make the Q-Line luminaire suitable for workstations. Thanks to the TRIAC dimmable LED driver, the luminaire can be directly connected to the 230 Volt mains voltage supply.



TECHNICAL DATA

Item no.:	1000936
Lamps included	0
Number of different light outlets	1
Primary nominal voltage	220-240V ~50/60Hz mA/V
Secondary power / secondary voltage	900 mA/V
Length	200.0 cm
Pendant length	150.0 cm
Width	6.0 cm
Height	6.0 cm
Net weight	4.444 kg
Gross weight	5.273 kg
Safety class	I
Assembly	Surface
Assembly details	Ceiling
Dimmable	Ja
Dimming technology	Leading edge
Wattage	85.0 W
Lumen	4600 lm
Colour temperature	4000 Kelvin
Beam angle	30 °
CRI	>90
UGR ?	10



Binning	6
LXXBXX data	25000
Service life	25000 h
BIG WHITE Page	114

Notes
