

Data Sheet

SPECIFICATIONS		MOUNTING HOLES DIMENSIONS
Voltage (Max.)	32 VDC.	
Current Rating	From 30A – 100A (Max.)	
Termination	M5 threaded studs and hex nuts for fuse mounting	
Wire sizes	#2-8 AWG.	AMI FUSES DIMENSIONS
Fuse Specifications	For Use with AMI fuses	
Torque Rating	20 in-lb (2.25Nm) max.	
Mounting Torque Rating	44 in-lb (5Nm) max. M6 screws with washers (recommended)	
Temperature Rating	-40 °C to 125 °C	Circuit Diagram
		

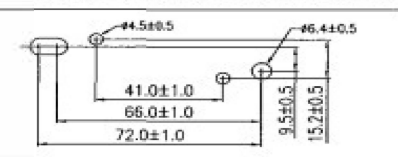
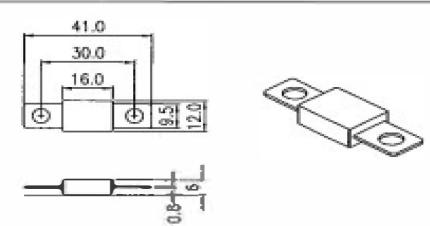
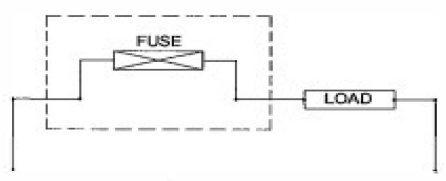
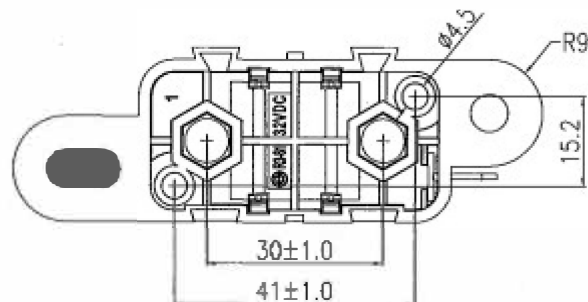
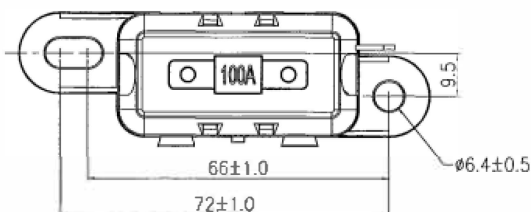
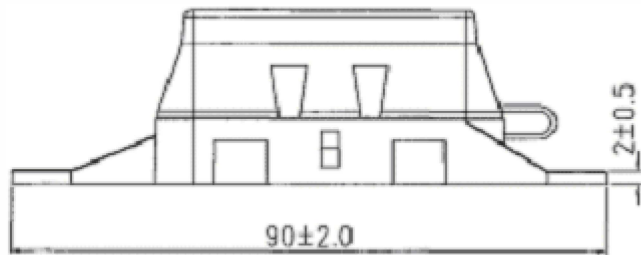
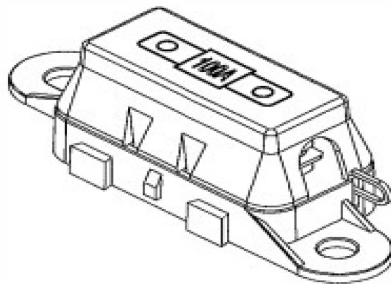
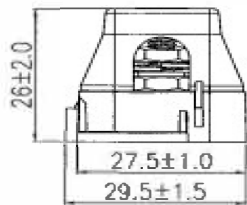

Material :
 Cover : Nylon-66 (Black)
 Housing : PBT, (Black)
 Screw : Ni.-Plated Steel studs

Notes :
 Fuse not included.