

FHD SMART TV S40F4012MC

USER'S MANUAL

GT06-S40F4012MC

TABLE OF CONTENTS

IMPORTANT INSTRUCTIONS	1
SAFETY INSTRUCTIONS	1
BATTERY HANDLING AND USAGE	2
FEATURES	2
TV STAND INSTALLATION	3
GENERAL PARTS	4
MAIN UNIT	4
REMOTE CONTROL	6
REMOTE CONTROL PREPARATION	8
BATTERY INSTALLATION	8
SERVICE LIFE OF BATTERIES	8
REMOTE CONTROL OPERATION	8
BASIC CONNECTION	9
CONNECTING TO AC POWER SOURCE	9
CONNECT EXTERNAL ANTENNA TO UNIT	9
HD-INPUT CONNECTION	10
PC/VGA CONNECTION	10
SCART CONNECTION	11
AV (COMPOSITE VIDEO) CONNECTION	11
YPbPr CONNECTION	12
LAN (RJ45) Connection	12
USB CONNECTION	12
INSERT CI CARD	13
COAXIAL CONNECTION	13
CONNECT EARPHONE TO THE UNIT	13
BASIC OPERATIONS	14
STARTING	16
SMART TV OPERATION	17
1. Browser	18
2. File Manager	19
3. Application manager	19
4. Settings	20
Basic Operations:	20
MAIN MENU	21
DTV MODE	21
1. Channel	21
2. Picture	23
3. Sound	24
4. Advance	25
ATV AND OTHER MODES	26
SATELLITE MODE	26
1. Auto Tuning	26
2. Dish Setup	26
MAINTENANCE	29
WALL MOUNTING	29
SPECIFICATIONS	30
GENERAL TROUBLESHOOTING	32

IMPORTANT INSTRUCTIONS

SAFETY INSTRUCTIONS



WARNING! TO REDUCE THE RISK OF FIRE, ELECTRIC SHOCK, OR SERIOUS PERSONAL INJURY:

- This product shall not be exposed to dripping or splashing and that no objects filled with liquids, such as vases, shall be placed on the apparatus.
- Situate this product away from heat sources such as radiators, heat registers, stoves, or other appliances (including amplifiers) that produce heat.
- Clean the product only as recommended by the manufacturer (see "Maintenance" section for details). Unplug the power cord from the wall outlet before cleaning.
- Unplug the power cord from the wall outlet when left unused for an extended period.
- Prevent objects/liquids from falling or spilled on the product.
- Operate the product only with the supplied power cord. Route power cords so they are not likely to be walked on or pinched by items placed upon or against them, paying particular attention to plugs, convenience receptacles, and the point where they exit from the product.
- Where the MAINS plug or an appliance coupler is used as the disconnect device, the disconnect device shall remain readily operable.
- Do not operate this product under the following conditions.
 - When the power-supply cord or plug is damaged.
 - If liquid has been spilled into or objects have fallen into the product.
 - If the product has been exposed to rain or water.
 - If the product does not operate when used according to the operating instructions.
 - If the product has been dropped or damaged in any way.
- Do not attempt to service the product; take it to the electronics repair shop of your choice for any servicing or repair.
- Do not overload wall outlets, extension cords, or integral convenience receptacles.
- Connect this product to the power outlet which has protective earth connection.
- The ventilation should not be impeded by covering the ventilation openings with items, such as newspapers, table-cloths, curtains, etc.
- No naked flame sources, such as lighted candles, should be placed on the apparatus;
- The device is intended for use only in a temperate climate.



CAUTION! TO REDUCE THE RISK OR PERSONAL INJURY OR PRODUCT/PROPERTY DAMAGE:

- This product is intended solely for non-commercial, non-industrial, personal use as a television. Do not use this product for any other purpose.
- Do not subject the product to violent shocks, extreme temperatures, or lengthy periods or direct sunlight.
- Keep the product away from magnetic objects, motors, and transformers.
- Do not use outdoors in inclement weather.
- Do not use the TV while driving; this is dangerous and is illegal in some areas.

WARNING!

Never place a television set in an unstable location. A television set may fall, causing serious personal injury or death. Many injuries, particularly to children, can be avoided by taking simple precautions such as:

- Using cabinets or stands recommended by the manufacturer of the television set.
- Only using furniture that can safely support the television set.
- Ensuring the television set is not overhanging the edge of the supporting furniture.
- Not placing the television set on tall furniture (for example, cupboards or bookcases) without anchoring both the furniture and the television set to a suitable support.
- Not placing the television set on cloth or other materials that may be located between the television set and supporting furniture.
- Educating children about the dangers of climbing on furniture to reach the television set or its controls.

If your existing television set is being retained and relocated, the same considerations as above should be applied.



AT FULL VOLUME, PROLONGED LISTENING MAY DAMAGE THE USER'S HEARING.

BATTERY HANDLING AND USAGE

- Keep batteries away from children and pets. Only adults should handle batteries.
- Never throw batteries into a fire or expose them to fire or other heat sources.
- Follow the battery safety and usage instructions.

	This symbol indicates DC Voltage (for USB only).
	This symbol indicates AC Voltage.



The European Directive 2012/19/EU on Waste Electrical and Electronic Equipment (WEEE), requires that old household electrical appliances must not be disposed of in the normal unsorted municipal waste stream. Old appliances must be collected separately in order to optimize the recovery and recycling of the materials they contain, and reduce the impact on human health and the environment. The crossed out "wheeled bin" symbol on the product reminds you of your obligation, that when you dispose of the appliance, it must be separately collected.

FEATURES

100 cm / 40-Inch (39.5") TFT DISPLAY

This unit has a built-in 100 cm / 40-Inch (39.5") TFT display to provide clear vision and low radiation.

- SMART TV
- AUTO TV SCANNING
- DIGITAL BROADCASTING RECEPTION (DVB-T, DVB-T2, DVB-S2 & DVB-C)
- H.265 / H.264 HD (HIGH-DEFINITION) VIDEO DECODING
- EPG (Electric Program Guide) FUNCTION
- TELETEXT (EUROPE) FUNCTION
- USB MULTIMEDIA PLAYBACK

- MULTI-LANGUAGE ON-SCREEN-DISPLAY
- FULL FUNCTION REMOTE CONTROL
- INPUTS: HD-INPUT, YPbPr, AV, CI, VGA, PC AUDIO, SCART
- CI PLUS (CI+) COMPATIBLE
- WI-FI (802.11b/g/n) & LAN (RJ45) CONNECTION
- COAXIAL OUTPUT
- EARPHONE OUTPUT
- DETACHABLE STAND HOLDER
- TV ANTENNA JACK (DVB-T/DVB-T2/DVB-C)
- SATELLITE TV ANTENNA JACK (DVB-S2)
- BUILT-IN SPEAKER

TV STAND INSTALLATION

Your TV is packaged with the Stand and the Cabinet separated. Before enjoying this TV, please carry out the Stand Installation according to the instructions below.

Step 1

Place the TV faced down on a soft cloth or cushion to prevent the panel from being damaged.

Step 2

Assemble the TV as shown in the figure.

Step 3

Tighten the included screws with a screw driver.

NOTES:

- 1) Unplug the power cord first when installing or removing the TV Stand.
- 2) Contact one or more partner for assistance when installing or removing the TV stand.

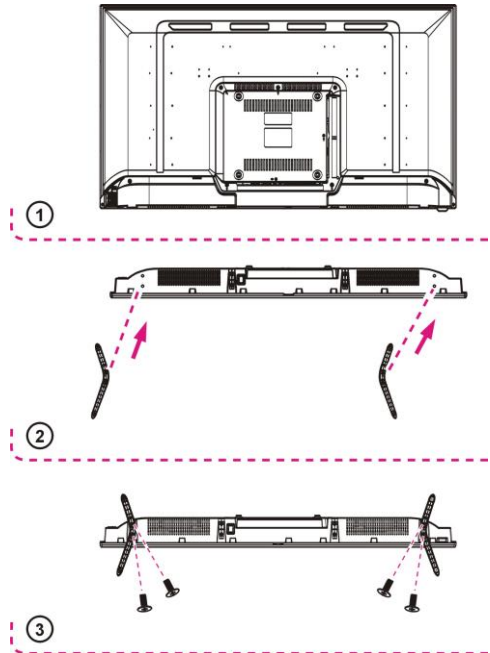

GENERAL PARTS

MAIN UNIT

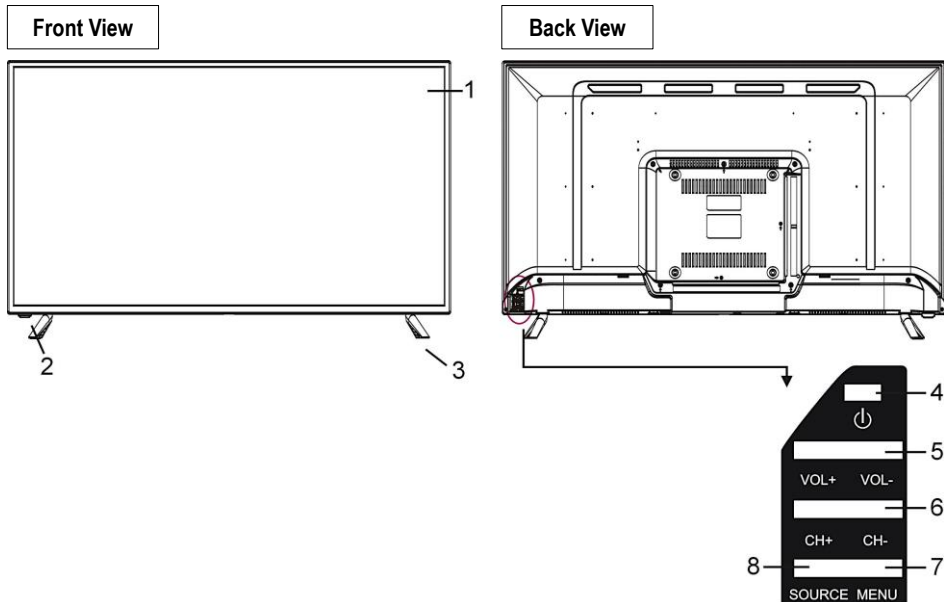

1. TFT Display Screen
2. Remote Control Sensor / Power Indicator:
In standby mode the indicator light will display red color; when switching on the unit the indicator light will display blue color.
3. Stand Holder
4. STANDBY Button:
To turn ON/OFF the TV.
5. VOL +/- Button:
To increase/decrease the volume level or move left/right.
6. CH +/- Button:
To select next/ previous channel or move up/down.
7. MENU Button:
To enter menu setting page.
8. SOURCE Button:
To select the input source.

Back View

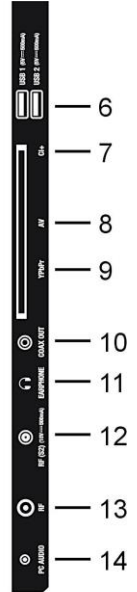
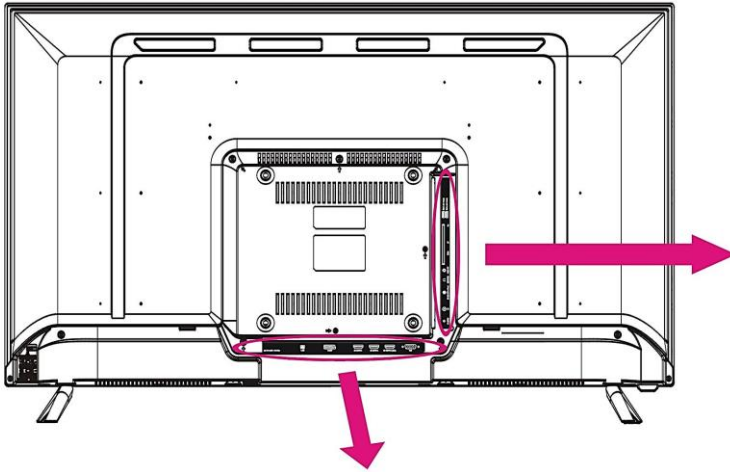

1. POWER input
2. LAN (RJ45) input terminal
3. SCART input terminal
4. HD-INPUT 1/2/3 terminals
5. VGA input terminal
6. USB 1/2 input slot
7. CI input terminal (CI+ compatible)
8. Mini AV input terminal
9. Mini YPbPr input terminal
10. COAXIAL output terminal
11. EARPHONE output terminal
12. RF input terminal - To connect the external Satellite TV Antenna (DVB-S2)
13. RF input terminal - To connect the external TV antenna (DVB-T/DVB-T2/DVB-C)
14. PC AUDIO input terminal







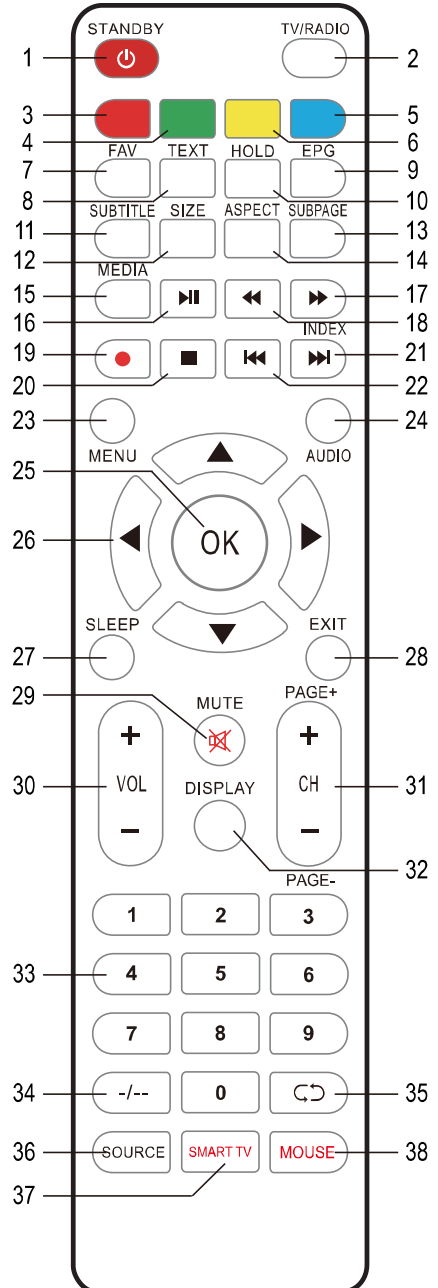

NOTE:







HD-INPUT 3 can support "ARC" function.

REMOTE CONTROL

1		Set the unit in standby mode; press it again to switch it on.
2		Switch the unit between TV and Radio.
3		RED Button
4		GREEN Button
5		BLUE Button
6		YELLOW Button
7		Display the favorite channels list.
8		Display the available Teletext.
9		Display electronic program guide.
10		Hold the Teletext.
11		Enable/disable subtitles.
12		Switch Teletext size.
13		Enter Teletext sub-page.
14		Press it repeatedly to select desired screen size.
15		Enter Media (USB) mode directly.
16		Start/Pause playing.
17		Move fast forward
18		Move fast backward
19		No function for this model.
20		Stop playing
21		: Play the next file. INDEX (DTV) : Display the record list or Teletext index.
22		Play the previous file.



23		Call out the main menu or return to previous menu.
24		Switch the available sound-track.
25		Confirm selection.
26		▲▼◀▶: Navigation buttons
27		Set desired sleep time.
28		Exit the menu page.
29		Mute the sound.
30		Increase/decrease the volume level.
31		Play the next/previous program.

32		Display the available program information.
33		Number Buttons (0-9): Input the number information, such as channel number and so on.
34		Switch the digit when watching TV programs.
35		Return to previous channel.
36		Select desired input source.
37		Enter Home page of Smart TV.
38		In Smart TV, press this button once to open on-screen mouse (Mouse mode); press it twice to enter "Navigation mode" (In "Navigation mode", use LEFT/RIGHT or UP/DOWN navigation buttons to scroll the page horizontally or vertically.); press it three times to and wait about 5 seconds till "Mouse" icon disappeared, now you have entered primary "Remote Control" mode.

REMOTE CONTROL PREPARATION

BATTERY INSTALLATION

Install the batteries as the following pictures. Be sure + and – terminals are positioned as indicated in the battery compartment (Fig 1).

SERVICE LIFE OF BATTERIES

- The batteries normally last for one year although this depends on how often the remote control is used.
- If the remote control fails to work even when it is operated near the player, replace the batteries.
- Use two AAA size dry batteries.

NOTES:

- Do not drop, step on or otherwise impact the remote control. This may damage the parts or lead to malfunction.
- If the remote control is not going to be used for a long time, remove the batteries.

REMOTE CONTROL OPERATION

Point the remote control from no more than about 6 m from the remote control sensor and within about 60° of the front of the player (Fig 2).

NOTES:

- The operating distance may vary according to the brightness of the room.
- Do not point bright light at remote control sensor.
- Do not place objects between the Remote control and the remote control Sensor.
- Do not use this remote control while simultaneously operating the remote control of any other equipment.

Fig 1



Fig 2

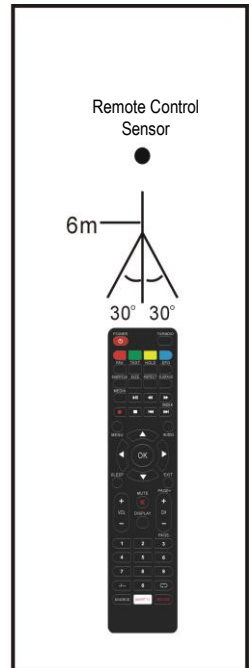

BASIC CONNECTION

- Ensure all the cables are disconnected from the main unit before connecting to AC power source.
- Read through the instructions before connecting other equipment.

CONNECTING TO AC POWER SOURCE

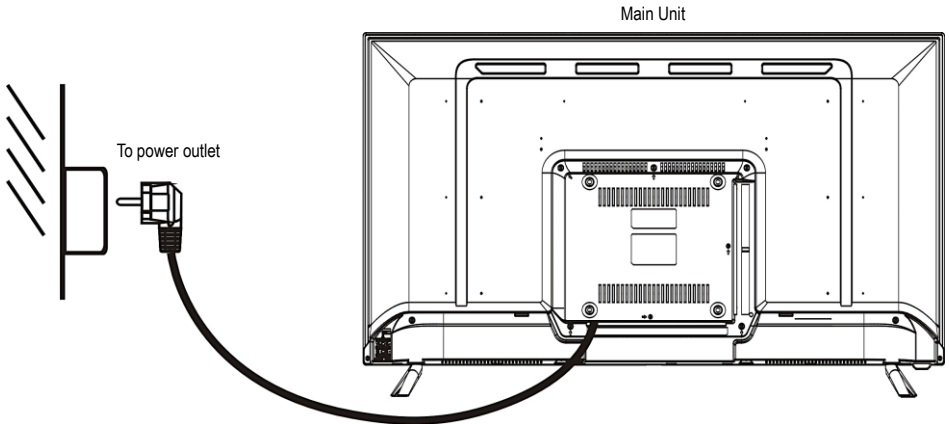

CONNECT EXTERNAL ANTENNA TO UNIT

Install external antenna into antenna jack for best picture.

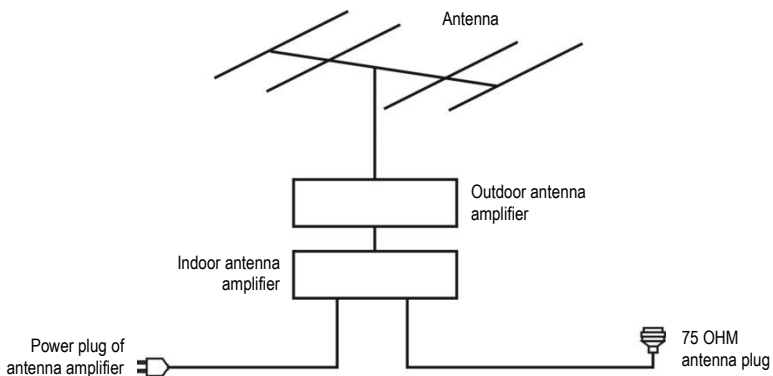

HD-INPUT CONNECTION

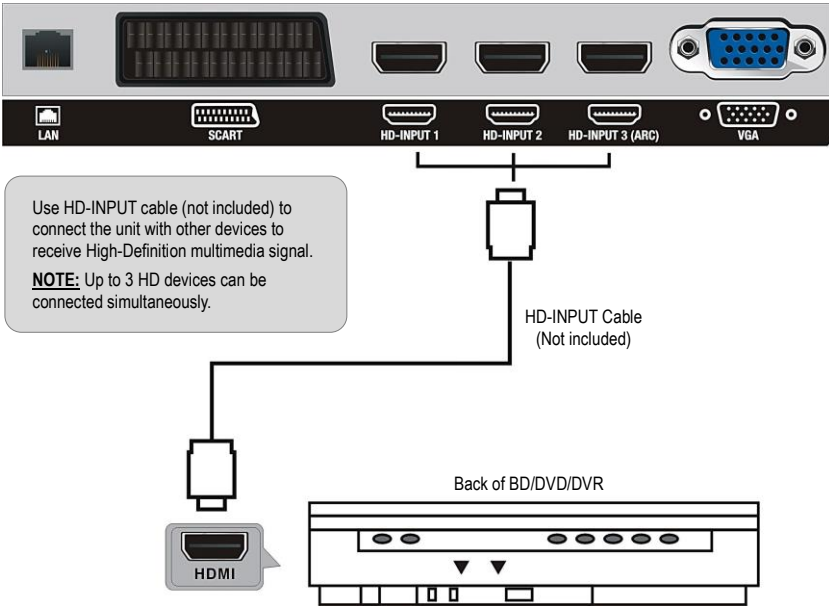

PC/VGA CONNECTION

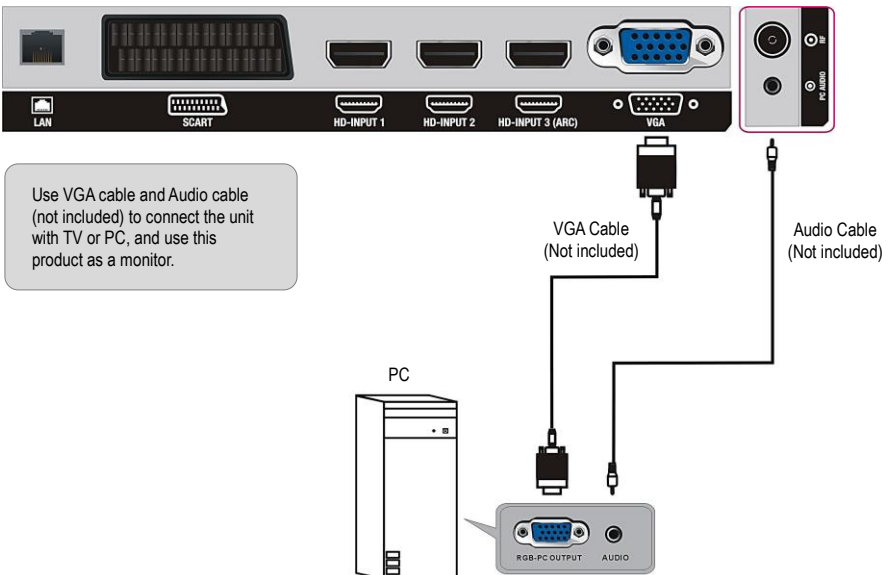

SCART CONNECTION

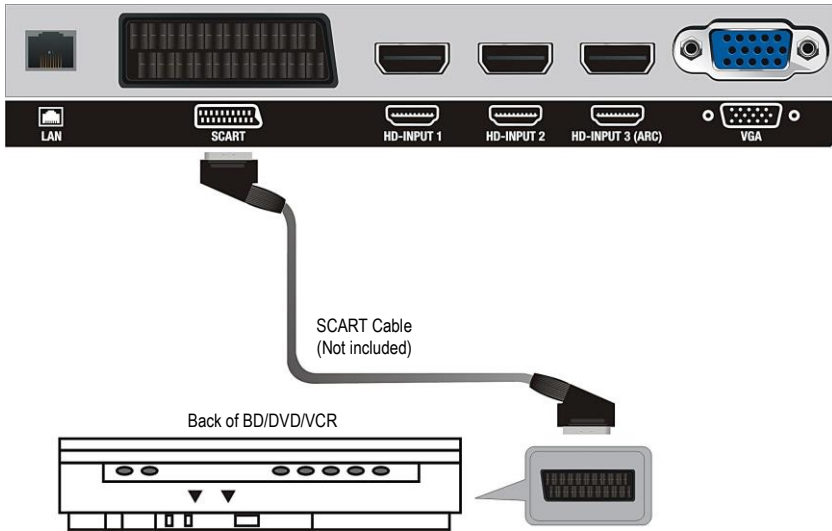

AV (COMPOSITE VIDEO) CONNECTION

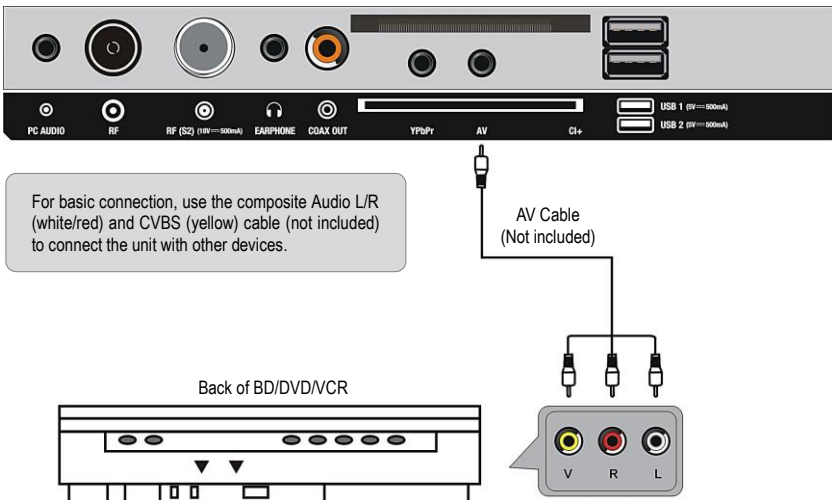

For basic connection, use the composite Audio L/R (white/red) and CVBS (yellow) cable (not included) to connect the unit with other devices.

YPBPR CONNECTION

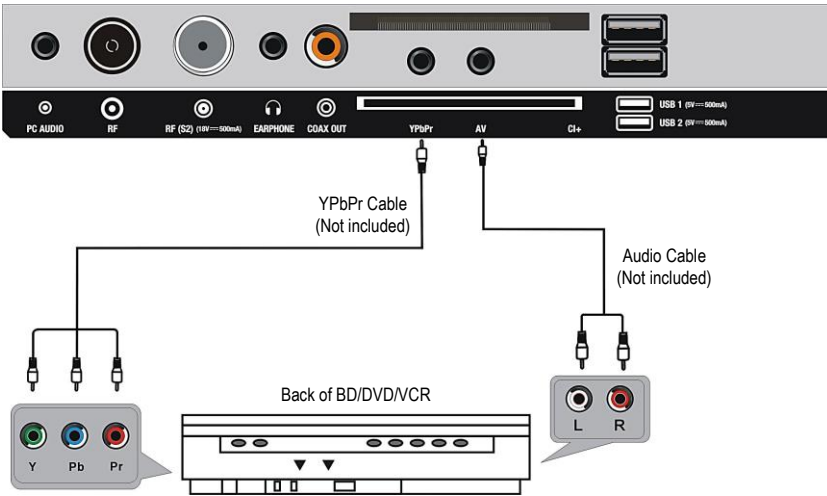

LAN (RJ45) CONNECTION

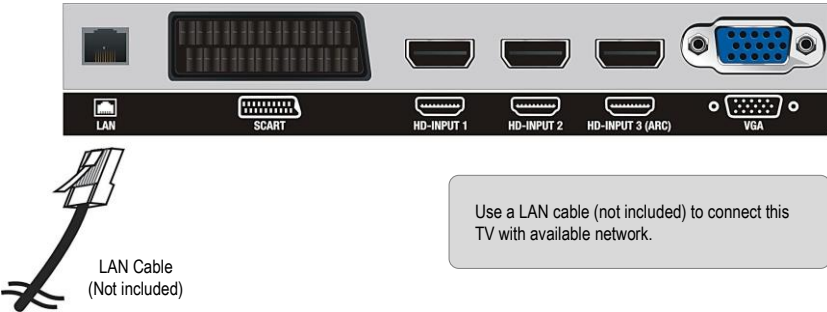

USB CONNECTION

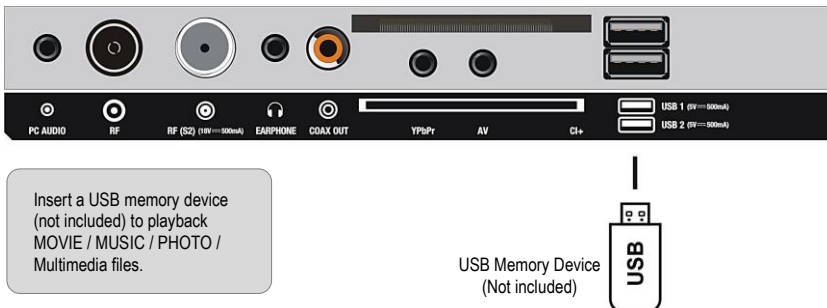

INSERT CI CARD

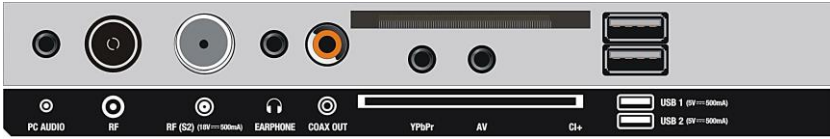

Insert your CI card (Conditional Access Module) to watch special digital channels in your area.

CI Card
(Not included)



COAXIAL CONNECTION

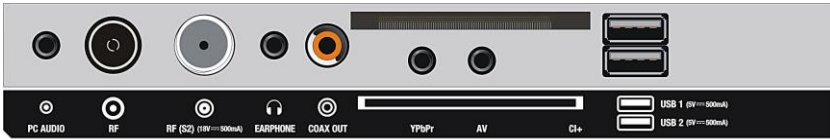

Use coaxial cable (not included) to connect the unit with amplifier or other audio decoding devices for coaxial audio signal output.

CONNECT EARPHONE TO THE UNIT

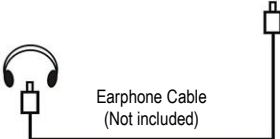
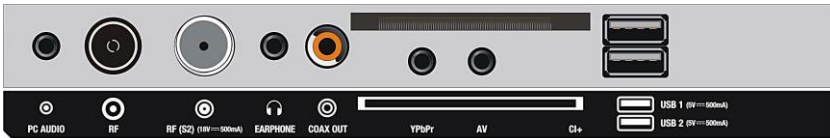

Earphone Cable
(Not included)

Make sure all the equipment and power cords are connected properly and the unit is set in correct mode before operation.

BASIC OPERATIONS

- Press STANDBY button on unit or remote control to power ON the unit (indicator will glow blue); press it again to power OFF (standby mode) the unit (indicator will glow red).
- Press SOURCE button on unit or remote control to set the unit in DTV or TV mode.

SELECT DESIRED PROGRAM

- Press CH+ button to play next channel.
- Press CH- button to play previous channel.
- Press number buttons on remote control directly to select wanted program.

NOTE: Press +/- button repeatedly to switch digit.

VOLUME CONTROL

- Press VOL+ or VOL- to adjust the level of current volume.
- Available range: 0-100.

MUTE CONTROL

Press MUTE button to mute the sound, press it again to turn on the sound.

SOURCE SETTING

- Press SOURCE button on unit or remote control to display the sources list.
- Press UP or DOWN navigation button to select desired input source, and then press OK button to confirm selection.
- Available options: DTV, ATV, AV, SCART, YPbPr, VGA, HD-INPUT 1/2/3.

MULTI-AUDIO SETTING

Press AUDIO button on remote control and use navigation buttons to select desired audio language.

NOTE: To enable this function, make sure that the channel you are viewing supports multi-audio languages.

INFORMATION DISPLAY

Press DISPLAY button on remote control to display information of current program.

TV GUIDE (FOR DTV MODE ONLY)

Press EPG button on remote control to display program guide.

800 ARTE HD	Fri ARTE JOURNAL 19:45 - 20:00	18 / 06 / 2018
801 PARIS PR..	Fri MAX LA MENACE 20:00-20:25	18 / 06 / 2018
802 M6		18 / 06 / 2018
803 W9		18 / 06 / 2018
804 NT1		18 / 06 / 2018
		18 / 06 / 2018
		18 / 06 / 2018

OK Remind Select MENU Back EXIT Exit

- Press UP/DOWN navigation button to select preferred program.
- Press LEFT/RIGHT navigation button to switch between left column and right column.
- When a program is highlighted in the middle column, press OK button to set a reminder.

FAVORITE LIST

When viewing an available channel, press FAV button on remote control to enter Favorite List menu page.

- Press UP or DOWN navigation buttons to select preferred channel.
- Press OK button to confirm the selection.

NOTE:

To add a favorite channel, please refer to the operations of "Channel > Program Edit".

QUICK SELECT

When viewing an available channel, press OK button on remote control to enter Channel List menu page.

- Press UP or DOWN navigation buttons to select preferred channel.
- Press OK button to confirm the selection.

TELETEXT

Press TEXT button on remote control to display the available teletext information and press it again to stop playing the teletext.

TV/RADIO (FOR DTV MODE ONLY)

Press TV/RADIO button on remote control to switch between TV and radio mode.

SUBTITLE

Press SUBTITLE button on remote control repeatedly to select desired subtitle.

NOTE: To enable this function, make sure that the channel you are viewing supports multi-subtitle.



STARTING

Connect to power source and turn on this TV, welcome page will display on the screen (if it is the first time turning on this TV).

Press LEFT/RIGHT/UP/DOWN navigation buttons to select desired option, and press OK button to confirm selection. Press EXIT button to return to previous page.

Welcome

Press RIGHT navigation button to enter next page.

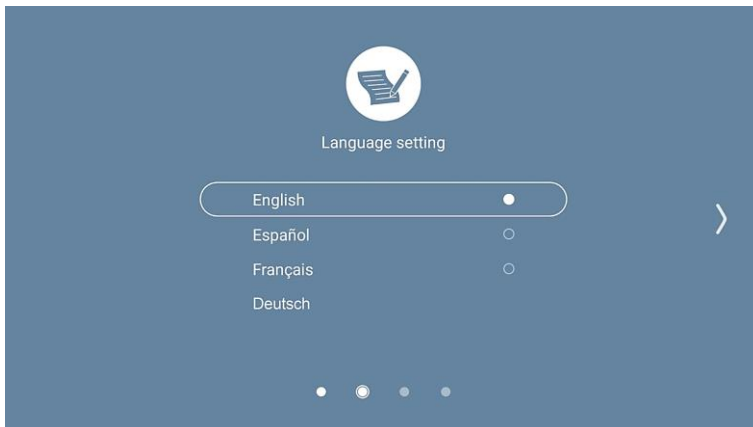
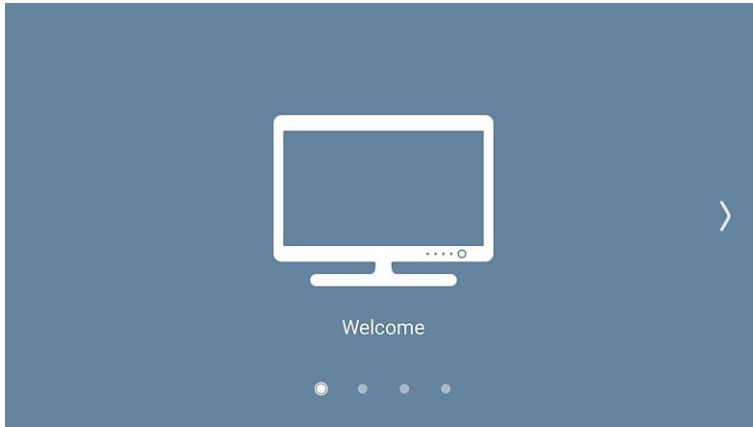

Language Setting

- Press UP/DOWN navigation button to select your language.
- Press RIGHT navigation button to enter next page.

Network

- If network cable has been connected to LAN port, select Ethernet Setting to configure it.
- If a Wi-Fi account is available, select Wireless to open Wi-Fi list and enter the password to connect it.
- After all, press RIGHT to finish starting setup and enjoy this TV.

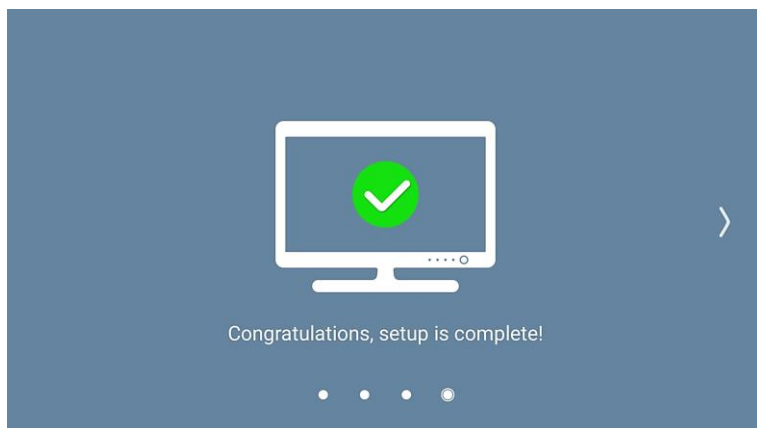
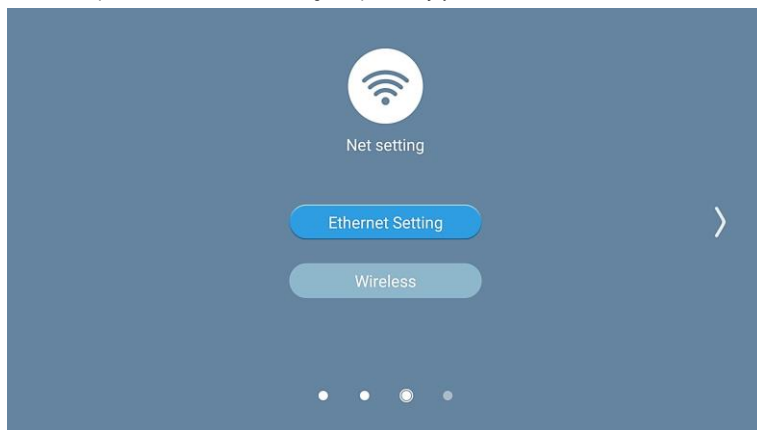

SMART TV OPERATION

- Press LEFT/RIGHT/UP/DOWN navigation buttons on Remote Control to select desired option, and press OK/ENTER button to confirm selection.
- Press EXIT button to return to previous page.
- Press SMART TV button to enter Home page.

NOTES:

- For more convenient operations, connect external Mouse (not included) to USB slot.
- External Mouse operations:
 - Click the LEFT button: Select an option or enter submenu.
 - Click the RIGHT button: Back to previous page.

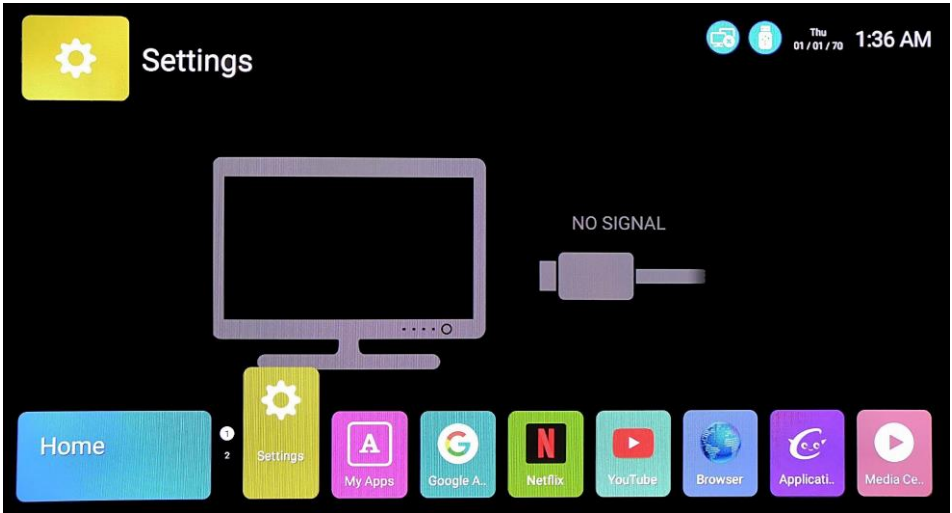

Before enjoying internet experience:

- Turn on Wi-Fi (Home page > Setting > Network > Wireless connection), if a Wi-Fi account is available in your area.
- Or connect your LAN cable and TV will connect network automatically.

1. BROWSER

- Use UP/DOWN/LEFT/RIGHT navigation buttons to select "Browser" on HOME page and press OK/ENTER button to open it.

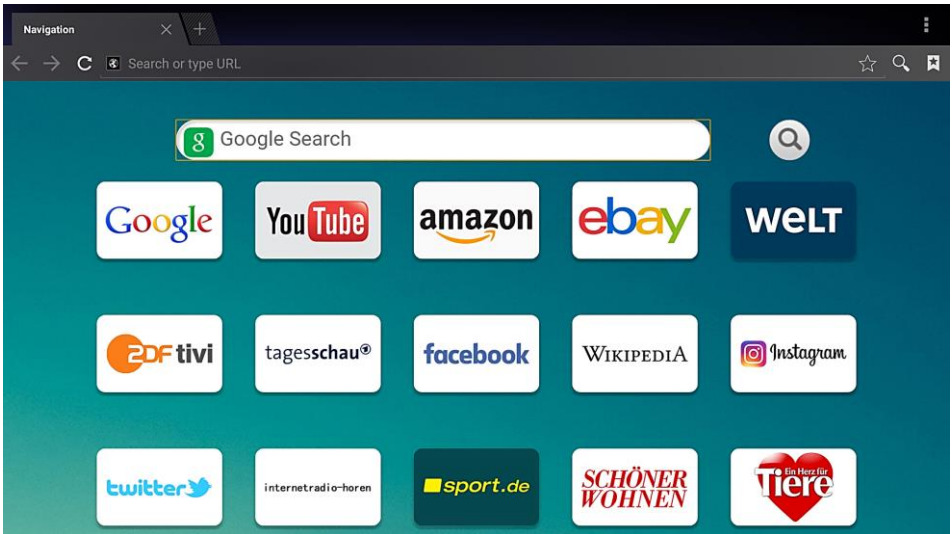

- Use UP/DOWN/LEFT/RIGHT navigation buttons to move the cursor to input field.
- Press OK/ENTER button to open the on-screen keyboard.
- Then use UP/DOWN/LEFT/RIGHT navigation buttons to select desired option and press OK/ENTER button to confirm input.
- When inputting finished, select "Go" on screen and press OK/ENTER to enter a webpage.

2. FILE MANAGER

- Insert a USB memory device into USB slot before following operations.
- Use UP/DOWN/LEFT/RIGHT navigation buttons to "File Manager" on HOME page and press OK/ENTER button to open it.
- Press EXIT button to return to previous page.

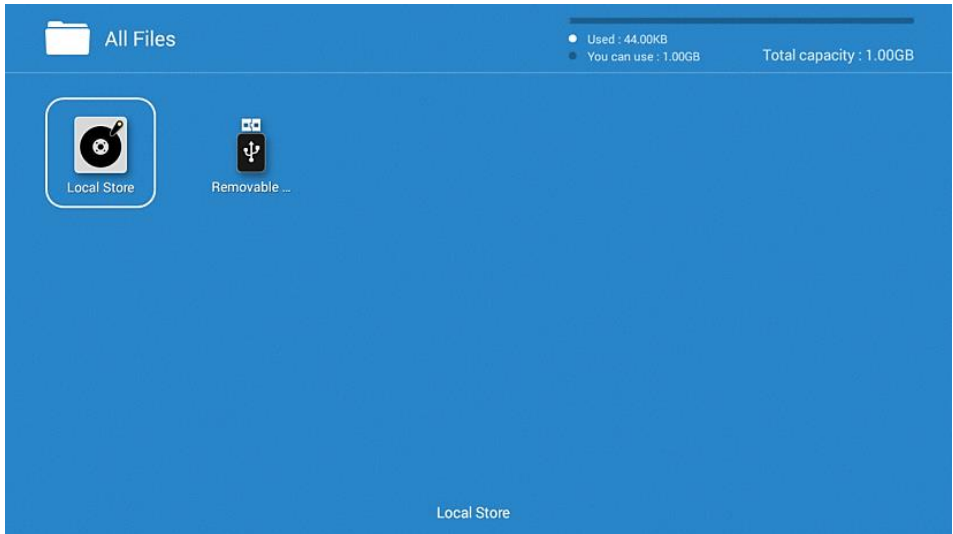

- Use navigation buttons to select multimedia (Video, Music, Photo) in your USB memory device or internal memory and press OK/ENTER button to start playback.

3. APPLICATION MANAGER

- Use UP/DOWN/LEFT/RIGHT navigation buttons to select "Application manager" on HOME page and press OK/ENTER button to open it.



- You can install an application from internal memory or external USB device; uninstall a new installed application; clean memory.

4. SETTINGS

Use UP/DOWN/LEFT/RIGHT navigation buttons to select "Setting" on HOME page and press OK/ENTER button open it.

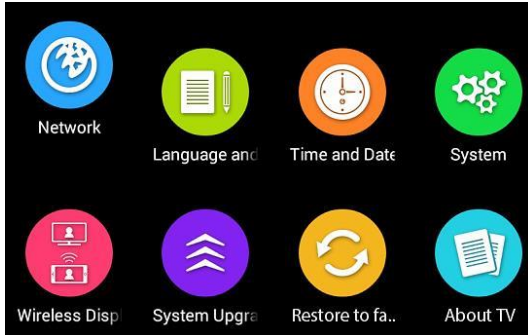

BASIC OPERATIONS:

- Use UP/DOWN/LEFT/RIGHT navigation buttons to select or adjust an option.
- Press OK/ENTER button to confirm selection.
- Press EXIT button to return to previous page.

Network

Network Status: display current network status.

Wired Connection: if LAN is connected, configure the IP address here.

Wireless connection: turn on/off Wi-Fi.

(Note: It needs a password to access an encrypted Wi-Fi)

Wireless Hotspot: set the wireless hotspot.

Language & input

Select OSD available language.

Time and Date

Set date, time, time zone, time format and date format here.

System

Allow installation of non AppStore application

Theme style settings: Select daytime or night theme style.

Home Display Time: Set the display time of Home page.

Cache Cleaner: Clean system cache.

Google Account Manager: Manage Google account if you have one.

Wireless Display

Project other electronic device onto this TV screen.

(Note: Make sure your device supports Wireless Display function and used the same wireless network with this product.)

System Upgrade

Upgrade the system.

Restore to Factory Settings

Reset the product to factory default setting.

About

Display Smart TV system information.

MAIN MENU

- The unit contains different setting menus. Once the initial programming is entered, it will be remained in the memory until change, and the unit can always be operated under the same conditions.
- The settings will be remained in the memory until the settings are changed, even after setting the player to standby mode.

Common procedure for initial settings

- Press MENU button on the remote control to display the main menu.
- Press UP/DOWN/LEFT/RIGHT navigation buttons to move the cursor.
- Press OK or RIGHT navigation button to enter submenu.
- Press MENU button to save current setting and return to previous menu page.
- Press EXIT button to exit menu page.

DTV MODE

Press SOURCE button on the unit or remote control to select DTV input source.

1. CHANNEL

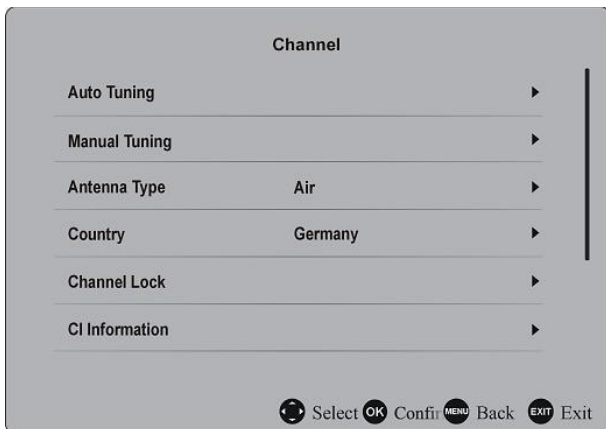

1.1 Auto Tuning

- Press OK navigation button to enter it.
- Use navigation buttons to select ATV, DTV or ATV+DTV auto tuning.

NOTE: Please connect an antenna to RF terminal on TV back before auto tuning.

1.2 Manual Tuning

- Press OK navigation button to enter it.
- Move the cursor up/down to select ATV or DTV manual tuning and press OK to enter submenu.

ATV Manual Tuning

Channel: select a channel number.

Color System: select available color system.

Sound System: select available sound system.

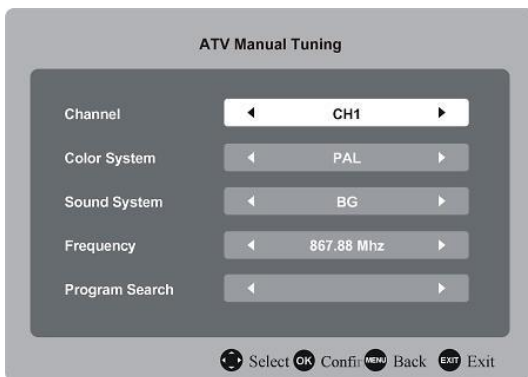

Frequency: adjust the frequency.

Program Search: Start scanning backward or forward from current frequency.

DTV Manual Tuning

- Press LEFT/RIGHT navigation button to select the channel.
- Then press UP/DOWN to highlight "Program Search" and press OK button to search channels.

NOTE: When Antenna Type is "Cable", you can adjust more options (frequency, modulation, symbol).

1.3 Antenna Type

Select Air, Cable or Satellite according to your antenna type.

1.4 Country

Select the country you're living in.

1.5 Channel Lock

- Input the factory default password "0000" using number buttons on remote control.
- Press UP/DOWN navigation button to select preferred item.

NOTE: If you forget the password, please use the universal password "8899".

Switch: Turn on/off System Lock.

Block Program: Lock/unlock saved programs.

Parental Guidance: Select available rating of parental guidance.

Change Password: Input the old password firstly, then input your new password twice to change it.

1.6 Hotel Mode

NOTE: To enter "Hotel Mode", press "SOURCE+1147" on Remote Control and then use UP/DOWN/LEFT/RIGHT navigation buttons to select or adjust an option.

Hotel Lock: Turn on/off Hotel Mode.

Channel: Turn on/off the lock of "Channel" menu.

Picture: Turn on/off the lock of "Picture" menu.

Sound: Turn on/off the lock of "Sound" menu.

Channel Lock: Turn on/off Channel Lock. If turn on, you can only watch current TV program.

Power ON Mode: If you selected "Direct", this product will power on automatically when you reconnected it to power outlet; for "Memory", this product will memorize current power condition; for "Secondary", this product will not power on automatically.

Key Lock: Turn on/off the keyboard lock.

Source Lock: Turn on/off the lock of available sources.

Boot Information Settings: Set boot interface or default source.

Max Volume: Set the maximum volume level.

Default Volume: Set the default volume level.

Clear Lock: Clear above settings.

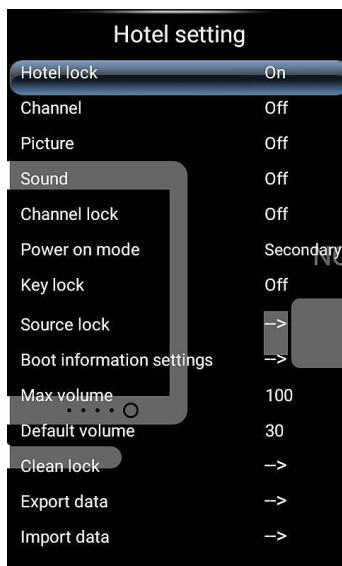
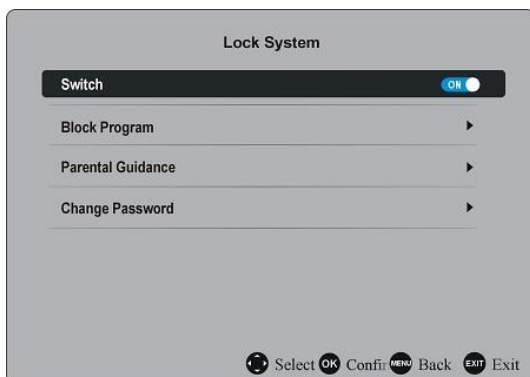
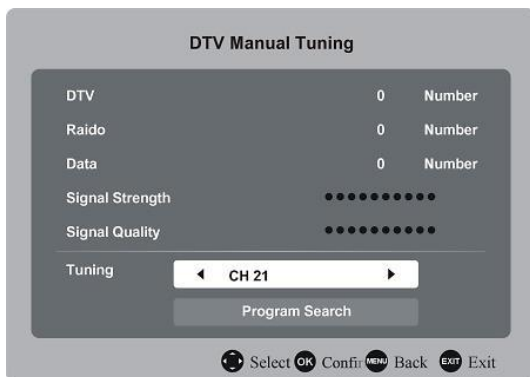

Export Data: Export database to USB device.

Import Data: Import database from USB device.

1.7 CI information

When an available CAM (Conditional Access Module) card is connected to the CI slot, the users can view related information or manage your CAM card.

1.8 Signal information

Display signal details, for example: signal quality and strength.

1.9 Program Guide

Display Program Guide (please refer to the operations of "Basic Operations>TV Guide".

1.10 Program Edit

- Press OK navigation button to enter it.
- Press UP/DOWN navigation button to highlight desired channel.
- Press RIGHT navigation button to set current channel as a favorite channel, and press RIGHT button again to move current channel from Favorite List.

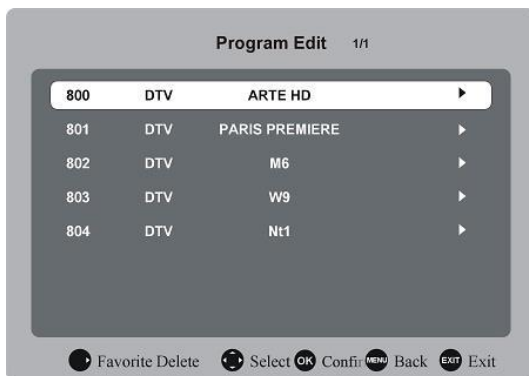

2. PICTURE

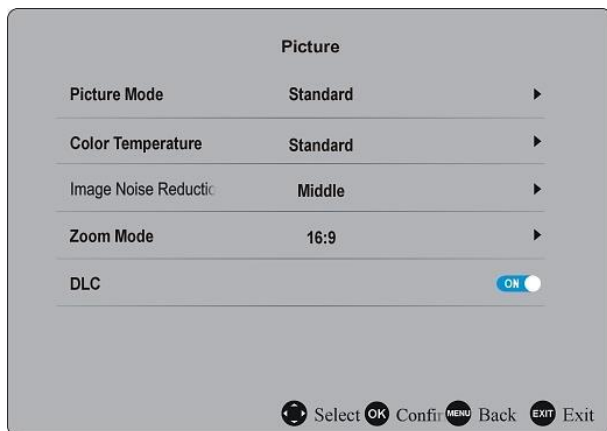

2.1 Picture Mode

Press UP/DOWN/LEFT/RIGHT navigation buttons to select an option.

Picture Mode: Standard, User, Soft, Vivid.

Brightness / Contrast / Colour / Sharpness: Adjustable value: 0-100.

When Picture Mode is selected [User], press OK/ENTER to enter submenu and adjust brightness, contrast and so on information.

2.2 Color Temperature

This item is used to adjust the optimum color temperature for suitable viewing.

Available options: Standard, Warm, Cool.

2.3 Image Noise Reduction

Available options: Off, Low, Middle, Strong.

2.4 Zoom Mode

This item is used to adjust the video size.

Available options: Auto, 4:3, 16:9, Zoom1, Zoom2.

NOTE: The available video size may be different for different input source.

2.5 DLC

Turn on/off Dynamic Luminance Control.

3. SOUND

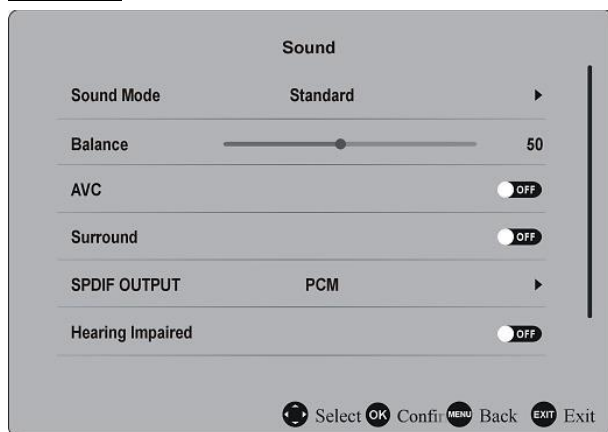

3.1 Sound Mode

Press UP/DOWN/LEFT/RIGHT navigation buttons to select an option.

Sound Mode: Standard, User, Music, Movie, Sports.

When Sound Mode is selected [User], press OK/ENTER to enter submenu and adjust bass and treble.

3.2 Balance

This item is used to adjust the audio output between left and right speaker from -50 to 50.

3.3 AVC (Auto Volume)

This item is used to set Auto Volume ON or OFF.

3.4 Surround

Turn on/off Surround Sound for better sound experience.

3.5 SPDIF Output

Available options: Off, RAW, PCM.

3.6 Hearing Impaired

This item is used to turn on/off Hearing Impaired function. For Hearing Impaired users, this function can assist help to know a certain scene or action through the caption, instead of hearing it.

NOTE: Hearing Impaired function works only when you are viewing programs that contain related caption information.

3.7 Music Only

Press RIGHT navigation button to enable "Audio Only". Picture display on this product will turn off and press any key to exit" Audio Only".

4. ADVANCE

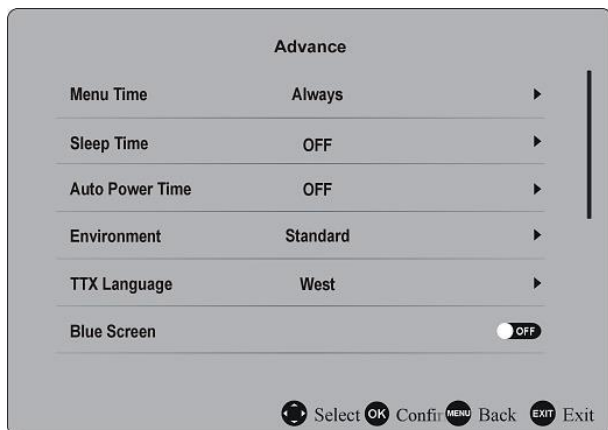

4.1 Menu Time

This item is used to select desired OSD menu active time.

Available options: Always, 5/10/15/20/30 seconds.

4.2 Sleep Time

This item is used to set the automatic sleep time when no signals.

Available options: Off, 10/20/30/60/90/120/180/240 minutes.

4.3 Auto Power Time

This item is used to select desired Auto Sleep (standby) duration when no operations were done through the remote control.

Available options: Off, 1/2/3/4 hours.

4.4 Environment

Select Home or Standard mode according to the use of this product.

4.5 TTX Language

This item is used to select desired teletext language.

4.6 Blue Screen

Turn on/off Blue Screen. The screen background will turn blue at very weak or no signal condition, if Blue Screen is ON.

4.7 HDMI CEC

Press OK/ENTER button to enter it.

To use HDMI CEC function:

- Make sure the HDMI device (Amplifier, etc.) is connected correctly.



- Press SOURCE button on the unit or remote control to select HDMI input source.

CEC: Turn on/off HDMI CEC.

Standby: Turn on/off auto standby.

ARC: Turn on/off ARC function.

4.8 Audio Language

This item is used to select desired audio language.

4.9 Subtitle Language

This item is used to select desired subtitle language.

4.10 Restore to Default

This item is used to recall factory default settings.

ATV AND OTHER MODES

- Press SOURCE button on the unit or remote control to select desired input source.
- For menu operations in these modes, please refer to the menu operations of DTV mode.

SATELLITE MODE

TIPS:

- Connect your Satellite antenna to the RF (S2) terminal first to receive satellite signals.
- Press SOURCE button on remote control to select "DTV".
- Make sure "Antenna Type" has been selected "Satellite".

1. AUTO TUNING

- Press MENU button to call out the main menu.
- Select "Channel" using navigation buttons and press RIGHT button to enter it.
- Then highlight "Auto Tuning" and press OK to enter it.

Satellite: Select an available satellite.

Scan Mode: Select your scan mode.

Service Type: Select a service type.

Channel Type: Select a channel type.

When finished above settings, highlight "Confirm" and press OK to scan satellite TV programs automatically.

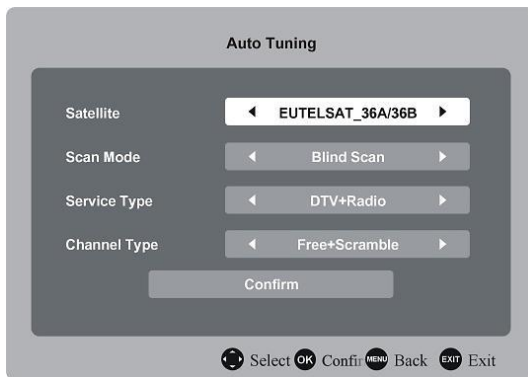

2. DISH SETUP

- Press MENU button to call out the main menu.
- Select "Channel" using navigation buttons and press RIGHT button to enter it.
- Then highlight "Dish Setup" and press OK to enter it.
- Press LEFT/RIGHT navigation button to highlight Left, Middle or Right column.
- Press MENU button to return.

Dish Setup

Satellite	Transponder	Setting
1 ASTRA 19.2E Ku	1 10744(MHz) 22000(kS/s) H	LNB Power 13/18V
2 HOTBIRD 6.7A,8 Ku	2 10773(MHz) 22000(kS/s) H	LNB Type 9750/10600
3 EUTELSAT W3A Ku	3 10803(MHz) 22000(kS/s) H	22kHz Tone Auto
4 EUTELSAT W1 Ku	4 10832(MHz) 22000(kS/s) H	Toneburst None
5 BADR-2,3,4/EURO Ku	5 10891(MHz) 22000(kS/s) H	DisEqc 1.0 None
6 EUTELSAT SESAT Ku	6 10921(MHz) 22000(kS/s) H	DisEqc 1.1 None
7 EUTELSAT W2 Ku	7 10964(MHz) 22000(kS/s) H	Motor None

Signal Quality ●●●●●●●●●●
Signal Strength ●●●●●●●●●●

Scan Delete Add Edit

Select OK Confir MENU Back EXIT Exit

A. When the “Satellite” (Left) column is highlighted:

- (1) Press **YELLOW** button on remote control to enter Add menu.

Rename

Press OK button to open on-screen keyboard. Then use UP/DOWN navigation buttons to make a new name and press OK to confirm selection.

Longitude Direction

Press LEFT/RIGHT navigation button to select desired option.

Longitude Angle

Press number buttons on remote control to input desired value.

Band

Press LEFT/RIGHT navigation button to select desired option.

Satellite Add

No.73 Name ▶

Longitude Direction ◀ East ▶

Longitude Angle ◀ 9.0 ▶

Band ◀ Ku ▶

OK Save MENU Exit

Satellite Edit

No.1 EUTELSAT_36A/36B ▶

Longitude Direction ◀ East ▶

Longitude Angle ◀ 35.9 ▶

Band ◀ Ku ▶

OK Save MENU Exit

- (2) Press **GREEN** button on remote control to enter Edit menu.

The operations of Edit menu are the same with Add menu.

- (3) Press **BLUE** button on remote control to enter Scan menu.

- Press UP/DOWN navigation button to highlighted desired item.
- Press LEFT/RIGHT navigation button to select desired Channel Type, Service Type and Scan Mode.
- Then press OK to scan programs automatically.

Search

Channel Type Free+Scamble ▶

Service Type DTV+Radio ▶

Scan Mode Default ▶

OK Scan MENU Exit

B. When the “Transponder” (Middle) column is highlighted:

- (1) Press **YELLOW** button on remote control to enter Add menu.

Frequency

Press LEFT/RIGHT navigation button to set desired frequency.

Symbol

Press LEFT/RIGHT navigation button to set desired Symbol value.

Polarization

Press LEFT/RIGHT navigation button to select desired option.

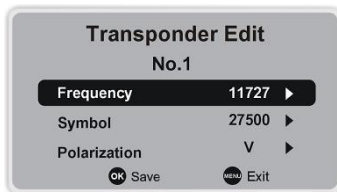
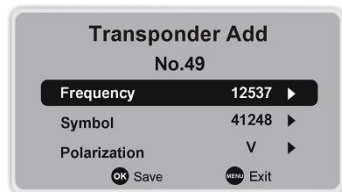

- (2) Press **GREEN** button on remote control to enter Edit menu.

The operations of Edit menu are the same with Add menu.

- (3) Press **BLUE** button on remote control to enter Scan menu.

- Press UP/DOWN navigation button to highlighted desired item.
- Press LEFT/RIGHT navigation button to select desired Channel Type, Service Type and Scan Mode.
- Then press OK to scan programs automatically.

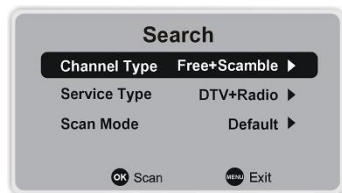

C. When the “Setting” (Right) column is highlighted:

LNB (Low Noise Block) Power

Press LEFT/RIGHT navigation button to select desired option.

LNB Type

Press OK button to enter submenu. Then use UP/DOWN navigation button to select desired option.

22 kHz Tone

Press LEFT/RIGHT navigation button to select desired option.

Toneburst

Press LEFT/RIGHT navigation button to select desired option.

DisEqc1.0 (Digital Satellite Equipment Control)

Press LEFT/RIGHT navigation button to select desired option.

DisEqc1.1

Press LEFT/RIGHT navigation button to select desired option.

Motor

Press LEFT/RIGHT navigation button to select desired option.

Single Cable (also known as “One Line Technology”)

Press OK button to enter submenu. Then use navigation buttons to select desired option.

MAINTENANCE

- Be sure to press STANDBY button to set the player to the standby mode and disconnect the power plug before maintaining the player.
- Wipe the player with a dry, soft cloth.
- If the surface is extremely dirty, wipe clean with a cloth which has been dipped in a weak soap-water solution and wrung out thoroughly, and then wipe again with a dry cloth.
- Never use alcohol, benzene, thinner, cleaning fluid or other chemicals. And do not use compressed air to remove dust.

WALL MOUNTING

- Contact a professional for assistance when wall mounting your TV. We are not responsible for any damage to the product or injury to yourself, if you mount the TV on your own.
- Do not wall mount the TV while TV is turned on. It may cause personal injury due to electric shock.
- Use standard M6 screws (12 mm / 4 pieces) to mount this TV.

Back of your TV

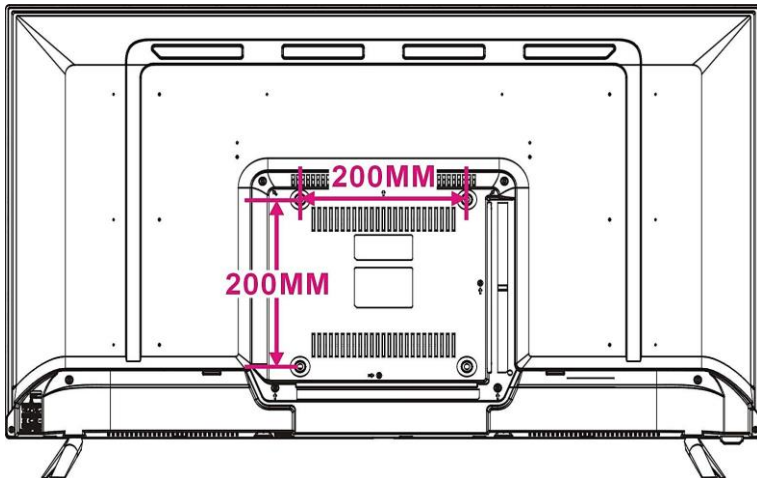

SPECIFICATIONS

DISPLAY DEVICE

Display	100 cm / 40-Inch (39.5") TFT panel with LED backlight
Resolution (pixels)	1920 x 1080
Pixel Pitch (mm)	0.076225 (H) x 0.2247 (V)
Aspect Ratio	16:9
Contrast Ratio	≤ 4000:1
Luminance	≤ 250 cd/m ²
View Angle	170 (H) / 160 (V)
Response Time	≥ 6 ms
Life Time	30,000 Hours

INPUT / OUTPUT TERMINALS

INPUT TERMINALS

RF (TV)	x 1
RF (Satellite TV)	x 1
PC-RGB (VGA)	x 1
PC AUDIO	x 1
USB	x 2
AV (Video)	x 1
Component (YPbPr)	x 1
SCART	x 1
CI (CI+ compatible)	x 1
HD-INPUT	x 3 (1.4)
LAN (RJ45)	x 1

OUTPUT TERMINALS

Coaxial	x 1
Earphone	x 1

ATV SYSTEM

Receiving Range	48.25 – 863.25 MHz
Input Impedance	75 Ω
Video System	PAL, SECAM
Sound System	BG, DK, I, L; NICAM/A2
Storage Channels	100 CH
Teletext	1000 pages

DTV SYSTEM

Receiving Range	48.5 - 2150 MHz
Input Impedance	75 Ω
Channel Bandwidth	7 MHz / 8 MHz
Modulation (DVB-T)	COFDM QPSK, 16QAM, 64QAM

Modulation (DVB-T2)	QPSK, 16QAM, 64QAM, 256QAM
Modulation (DVB-C)	16QAM, 32QAM, 64QAM, 128QAM, 256QAM
Modulation (DVB-S2)	QPSK, 8PSK
Video System	MPEG-2 MP@ML, MPEG-2 MP@HL, H.264, H.265
Sound System	MPEG-1 Layer 1/2, MPEG-2 Layer 2, DD, DD+
Basic Function	EPG, Subtitle, Teletext

VIDEO INPUT / AUDIO OUTPUT

VIDEO INPUT

AV Color System	PAL, NTSC, SECAM
YPbPr Format	480i, 480p, 576i, 576p, 720p, 1080i, 1080p
HD-INPUT Format	480i, 480p, 576i, 576p, 720p, 1080i, 1080p

AUDIO OUTPUT

Frequency Response	100 Hz - 15 kHz @ +/-3 dB (1 kHz, 0 dB reference signal)
Output Power	8W x 2 @ 8Ω THD < 10%
Speaker Unit	2 x Full-Range Driver (10W / 8Ω)

USB MULTIMEDIA FORMATS

Movie	AVI, MPG, MPEG, MKV, MOV, RMVB
Music	WMA, AAC, MP3
Photo	JPEG, BMP, PNG

SMART TV SYSTEM

Processor	358
Core Type	A35, 4-Core
GPU	Mali-400
RAM	1 GB
NAND Flash	8 GB

OTHERS

OSD Languages	German, English, French, Italian, Spanish, Portuguese, Dutch
Power Source	AC 100-240V, 50/60Hz
Power Consumption	Max. 60 W
Power Saving	< 0.5 W (in standby)
Operation Temperature	-5°C - 45°C
Dimension (mm)	907 (W) x 207 (D) x 568 (H) (with Stand)
	907 (W) x 81 (D) x 519 (H) (without Stand)
Weight	Approx. 5.6 Kg (with Stand)
	Approx. 5.5 Kg (without Stand)

*Specifications are subject to change without notice

GENERAL TROUBLESHOOTING

Check the following points before assuming malfunctions of this unit:

SYMPTOM	REMEDY
No power	Insert the power plug securely into the power outlet.
No picture	Ensure that the equipment is connected properly.
<ul style="list-style-type: none">No soundDistorted sound	<ul style="list-style-type: none">Ensure that the equipment is connected properly.Ensure that the input setting for the TV and stereo system are correct.Adjust the master volume to a suitable volume by pressing VOL+/VOL- button.
No operations can be performed with the remote control unit	<ul style="list-style-type: none">Check the batteries are installed with the correct polarities.The batteries are exhausted: Replace them with new ones.Point remote control at the remote control sensor and operate it again.Operate the remote control unit at a distance of no more than 6m from the remote control sensor.Remove the obstacles between the remote control and remote control sensor.
No key operation (by the main unit and/or the remote control unit) is effective	Disconnect the power plug and then reconnect it. (The player may not be operating properly due to lightning, static electricity or some other factors.)

SYMPTOM (TV)	REMEDY
No or poor picture	<ul style="list-style-type: none">Adjust antenna or use an external antenna.Relocate the unit near a window (if inside a building).Move units away from this product that causes interference.Do Auto Tuning again.Try another channel.
Sound noise or image noise	Check the antenna connection.
No sound or poor sound	<ul style="list-style-type: none">Check the audio settings.Press MUTE button on remote control to cancel mute function.Unplug the headphone.
Noise or other interface	Electronic equipment near the unit is causing interface. Relocate the unit or move the equipment.

SERVICE PROCEDURE

If you have reason for complaint, or your device is defective, please contact your dealer or the service division of MBM GmbH to make arrangements for service procedures.

Service Hours: Monday – Thursday
8:00 am to 5:00 pm
Friday from 8:00 am to 2:00 pm.

Phone No.: 02162-54931-0
Email: info@mbm-jtc.de

Please do not send your product to our address unless requested to do so by our service team. All costs and the risk of loss are the responsibility of the sender.
We reserve the right to reject unrequested deliveries, or return the package at the sender's expense.

EU DECLARATION OF CONFORMITY

Herewith the company MBM GmbH declares that the described product complies with the EU directive 2014/53/EU and the other applicable for the product.
The full text of the EU Declaration of Conformity is available at the following Internet address: www.mbm-jtc.de



The device carries the CE marking and complies with all required EU standards.

DIRECTIVE 2012/19/EU ON WASTE ELECTRICAL AND ELECTRONIC EQUIPMENT (WEEE)



This symbol on the product or in the instructions means that your electrical and electronic equipment should be disposed at the end of its life separately from your household waste. There are separate collection systems for recycling in the EU.
For more information, please contact the local authority or your retailer where you purchased the product.



INTENDED USE

The wireless adapter into the device is intended only for making a data connection via a wireless radio network to a wireless router or other Wi-Fi-enabled device.
Any other use or extended use is considered improper.
Any claims for damage resulting from improper use are excluded.
The risk is borne solely by the operator.
This product complies with the applicable national and European requirements.

APPLICATIONS

Built-in 802.11b/g/n Wireless Adapter (Frequency in the 2.4 GHz & 5.0 GHz band)
Applications of all channels in all European countries are allowed by ETSI (European Telecommunication Standards Institute).
The device can only be used within range of Wi-Fi enabled channels of 802.11b/g/n.

MBM GmbH

Sittarder Strasse 19
D-41748 Viersen
Germany

Tel. 02162-54931-0
www.mbm-jtc.de
info@mbm-jtc.de

