

© User Manual

MEGA X

Dear customer,

Thank you for choosing **ANYCUBIC** products.

Maybe you are familiar with 3D printing technology or have purchased **ANYCUBIC** printers before, we still highly recommend that you read this manual carefully. The installation techniques and precautions in this manual can help you avoid any unnecessary damage or frustration.

More information please refer to :

1. <http://www.anycubic.com/>

ANYCUBIC website provides software, videos, models, after-sale service, etc.

Please go to our website to report any issues and we are likely to answer or solve all the questions for you!

2. Facebook page and Youtube channel as shown below.



ANYCUBIC website



Facebook page



Youtube channel

Team **ANYCUBIC**

Safety instruction

Always follow the safety instructions during assembly and usage, to avoid any unnecessary damage to the machine or individual injury



Please contact our customer service first if you have any issue after receiving the products.



Be cautious when using the scraper. Never direct the scraper towards your hand.



In case of emergency, please immediately cut off the power of **ANYCUBIC** 3D printer and contact the technical support.



ANYCUBIC 3D printer includes moving parts that can cause injury.



It is recommended to wear protection glasses when printed models to avoid small particles contacting eyes.



Keep the **ANYCUBIC** 3D printer and its accessories out of the reach of children.



Vapors or fumes may be irritating at operating temperature. Always use the **ANYCUBIC** 3D printer in an open and well ventilated area.



ANYCUBIC 3D printer must not be exposed to water or rain.



ANYCUBIC 3D printer is designed to be used within ambient temperature ranging 8°C-40°C, and humidity ranging 20%-50%. Working outside those limits may result in low quality printing.



Do not disassemble **ANYCUBIC** 3D printer, please contact technical support if you have any question.



Contents

Technical Specification	1
Packing list	2
Product Overview	3
Menu Directory	4
Installation	8
Pre-installation check	9
Install frame	10
Wiring	12
Leveling	14
Manual Leveling	14
Supplements to leveling	17
Printing test	19
Filament in	19
Print test	21
Driver installation	23
Introduction to slicing software	25
Cura installation	25
Machine settings	26
Import the configuration file	29
Manipulate 3D model in Cura	31
Slice and preview	32
Print online	33
Print offline	34
Printing	35
Introduction to filament sensor	37
Resume from outage	38
Maintenance	40
Troubleshooting	41

Technical Specification

Printing

Technology:	FDM (Fused Deposition Modeling)
Build Size:	300×300×305 (mm ³)
Print accuracy:	0.05-0.3 mm
Positioning Accuracy:	X/Y 0.0125mm, Z 0.002mm
Extruder Quantity:	Single
Nozzle Diameter:	0.4 mm
Print Speed:	20~100mm/s (suggested 60mm/s)
Travel Speed:	100mm/s
Supported Materials:	PLA, ABS, HIPS, Wood, etc

Temperature

Ambient Operating Temperature:	8°C - 40°C
Operational Extruder Temperature:	max 250°C
Operational Print Bed Temperature:	max 90°C

Software

Slicer Software:	Cura
Software Input Formats:	.STL, .OBJ, .DAE, .AMF
Software Output Formats:	GCode
Connectivity:	Memory card; Data cable(expert users only)

















Electrical

Input rating:	110V/220V AC, 50/60Hz
---------------	-----------------------

Physical Dimensions

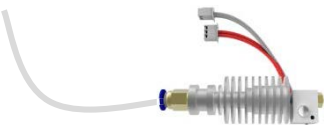
Printer Dimensions:	500mm×500mm×553mm
Net Weight:	~14kg

Packing list

		
<p>Mega X</p>	<p>M5*8 screw 10PCS</p>	<p>Plier 1PCS</p>
		
<p>Assembly instruction 1PCS</p>	<p>Filament holder 1PCS M3*5 screw 2PCS</p>	<p>Gift Filament 1PCS</p>
		
<p>Power cord 1PCS</p>	<p>After sale service card 1PCS</p>	<p>Filament sensor 1PCS</p>
		
<p>Memory card 1 PCS</p>	<p>Data cable 1PCS</p>	<p>Gloves 2PCS</p>
		
<p>Extra print head 1PCS</p>		<p>Tool kit 1 unit</p>
<p>Extra print head 1PCS</p>	<p>Tweezers& Nozzle cleaning needle 1 PCS each</p>	 <p>Scraper 1PCS</p>

Product Overview

Front view

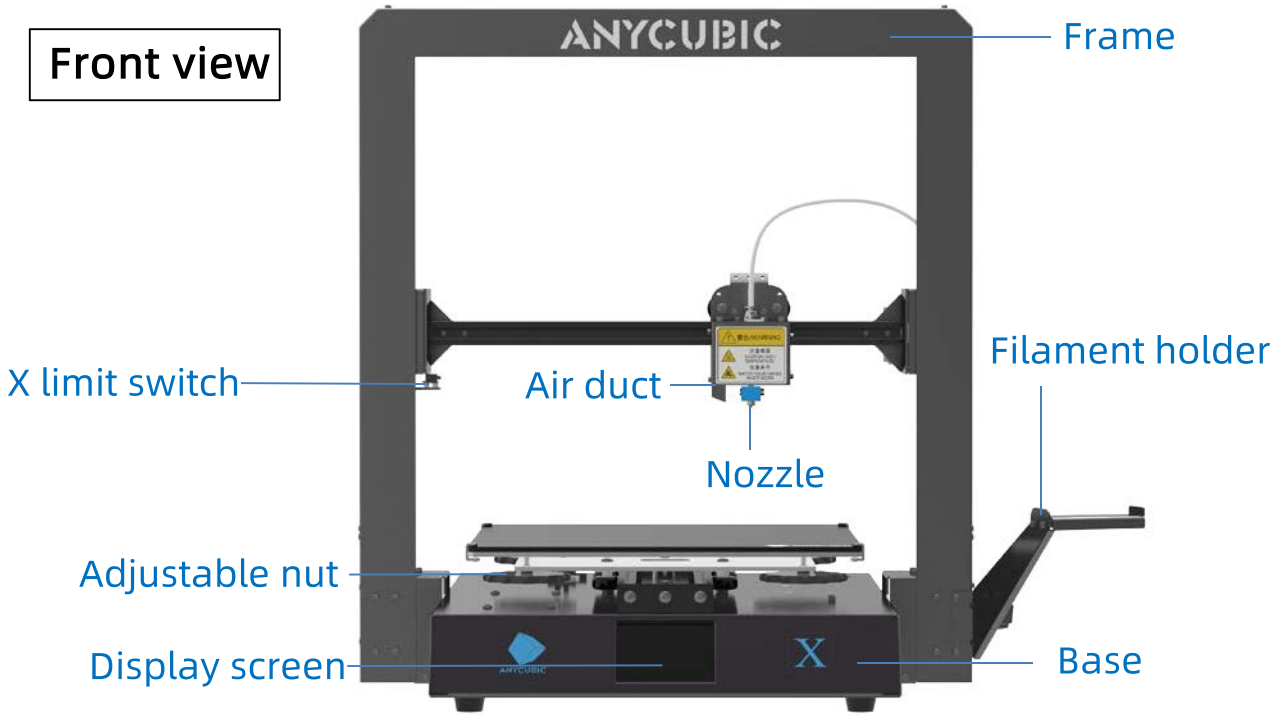

Back view

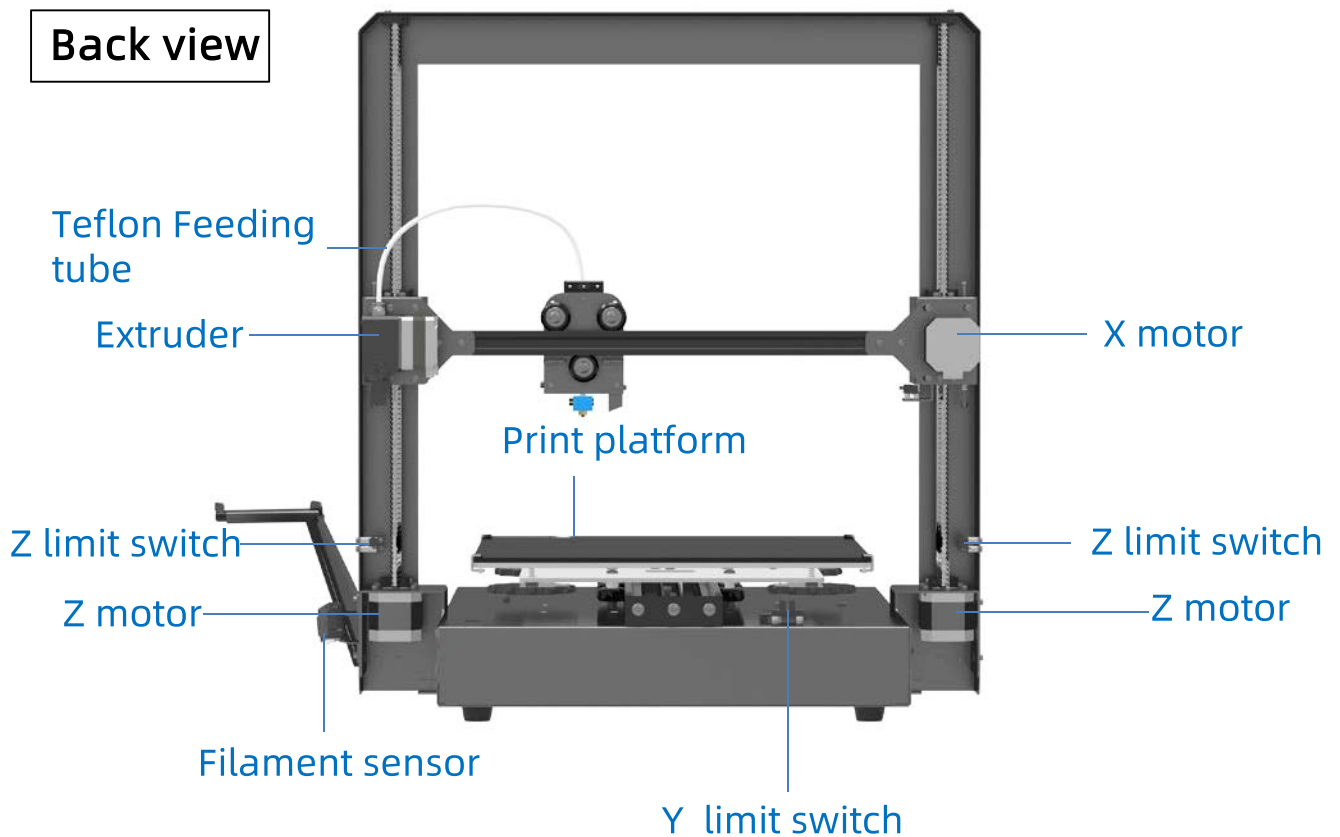

Menu Directory

Home menu

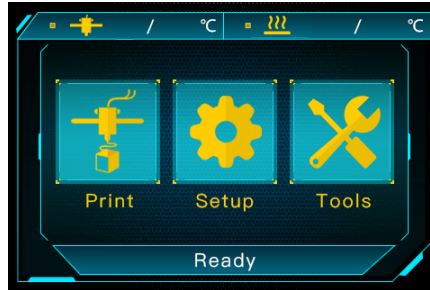

Print



Setup



Tools

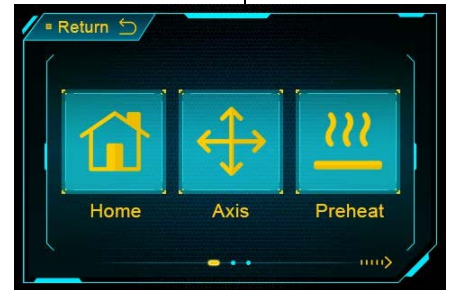

Setup



Tools

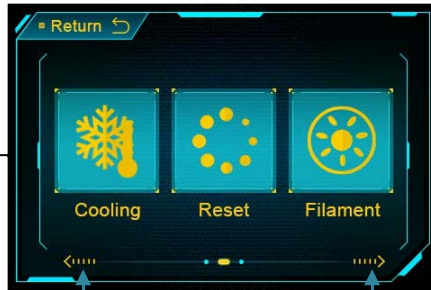

Tools



Previous page

Next page

Menu Directory

Home menu

Nozzle Temp /Target Temp

Heated bed Temp/Target Temp

Enter the print list

Enter the setup list

Enter the tools list

Printer status

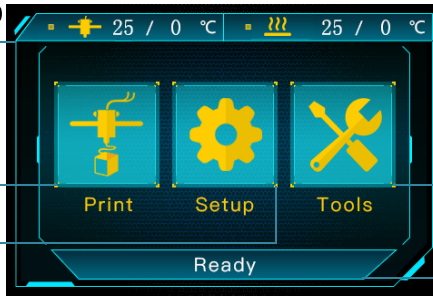

Print

Return to the home menu

File list

Print the selected files
in memory card

Page up

Page down

Refresh the list

Resume form outage (only valid
for offline print via memory card)



Setup

Language: Change language (English/Chinese)

Temperature:

Reduce nozzle Temp

Raise nozzle Temp

Current nozzle Temp

Current heated bed Temp

Click to set nozzle
Temp(170-260°C)

Click to set heated bed
Temp(0-100°C)

Reduce heated bed Temp

Raise heated bed Temp

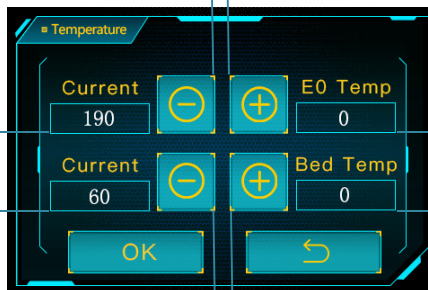

Menu Directory

Motor: Disable all motors (only valid when machine is not printing)

Speed:

Decrease fan speed Increase fan speed

Current fan speed Click to set fan speed(0-100%)

Current print rate Click to set print rate(50-100%)

Decrease print rate Increase print rate

Status: (the following with * is valid only for offline printing , i.e. print from memory card)

Return to previous menu

Files* Print Rate

Time Progress*

Nozzle Temp/Target Temp Heated bed Temp/Target Temp

Coordinates for X/Y/Z axis

Pause print* Stop print*

Voice: Turn on/off the screen sound

Tools

Home: (only valid when machine is not printing)

Return to previous menu

Click to home X Click to home Y

Click to home Z Click to home All

Menu Directory

Axis: (only valid when machine is not printing)



Move left/right X axis by 0.1/1.0/10mm

Move backward/forward Y axis by 0.1/1.0/10mm

Move down/up Z axis by 0.1/1.0/10mm

Return

Speed mode for axis move Low/Medium/High

Preheat: (only valid when machine is not printing)

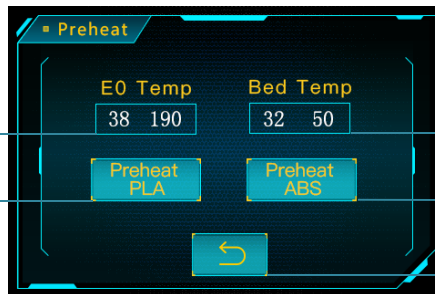

Nozzle Temp/Target Temp

Heated bed Temp/Target Temp

Click to preheat PLA

Click to preheat ABS

Return

Cooling: Cut off the power to hot-end and heated bed (only valid when machine is not printing)

Reset: Popup window to decide if reboot the mainboard

Filament: (only valid for offline print)

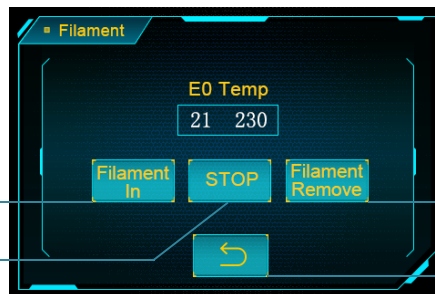

Automatically heating to the setting temperature for filament in

Automatically heating to the setting temperature for filament remove

Stop to filament in/remove

Return

Help: Basic description of the Menu

About: Information about the product

Installation

1. Installation section contains: ①Install the frame ②Wiring
2. Be cautious during assembly as some parts may have sharp edges.
3. It is suggested to use a flat desktop and place the parts in an orderly manner for quick assembly.
4. The color of some parts may be different from what in the manual, but the assembly is the same.
5. Firmware has been pre-uploaded to the motherboard. After completing the assembly, please level the platform and load the filament then you could start the first test print.
6. The print head must be covered with an insulated sleeve to maintain a constant temperature of the print head. Don't remove it.

Please note: every unit of the printer has been inspected and tested for printing. Therefore, in some cases, there might be very small marks left on the print head or on the heated bed. Those will not affect the printing quality and that means the printer has been tested for the quality. Meanwhile, we provide an extra hot end in case you need to replace it in the future. Thank you very much for your kind understanding.

Team **ANYCUBIC**

Installation

Pre-installation check: D-shape wheels of the base may be loosened due to transportation, please check it after unpacking.

Place the base on a flat desktop. Keep the heated bed stationary by hand, then turn the D-shape wheels, and if the wheels are idling, adjust them as follows.

D-shape wheel

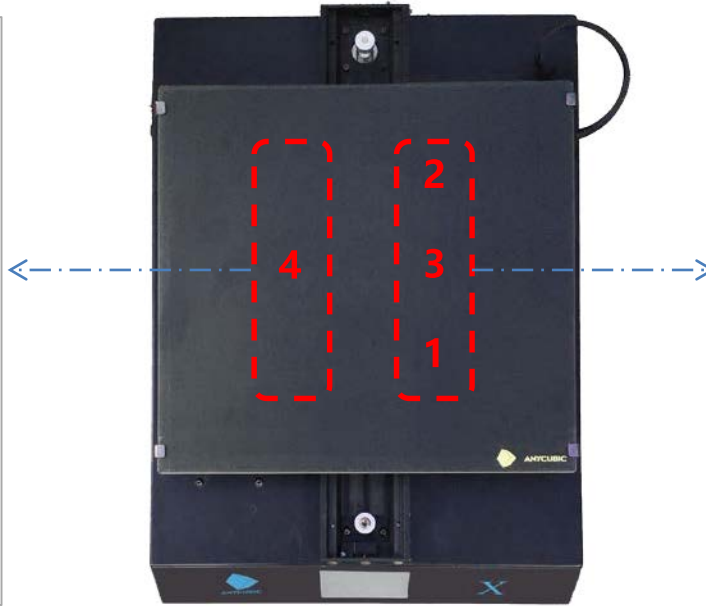
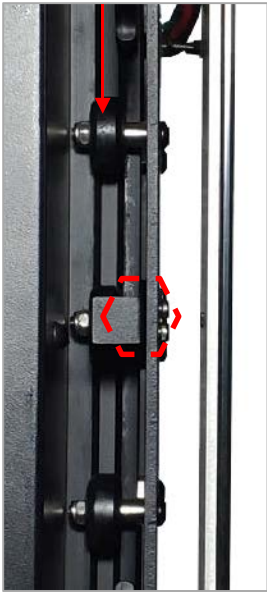

Hexagonal pillar

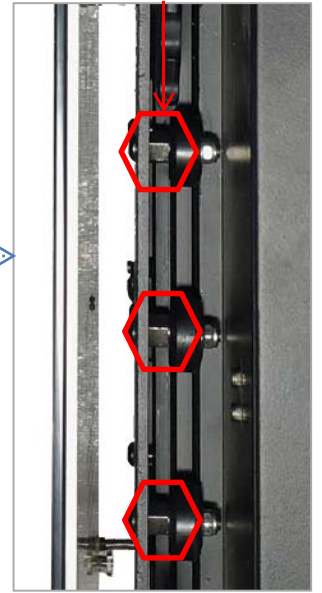

Adjustment method: Use a wrench to tighten the hexagonal pillars clockwise in the order of 1→2→3→4, as shown in the figure above. Then push the heated bed to observe until they can smoothly rotate with the movement of the heated bed.

② Tighten the hexagonal pillar clockwise with a 10mm opening wrench.

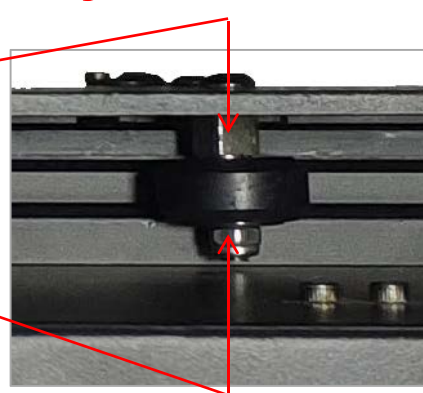
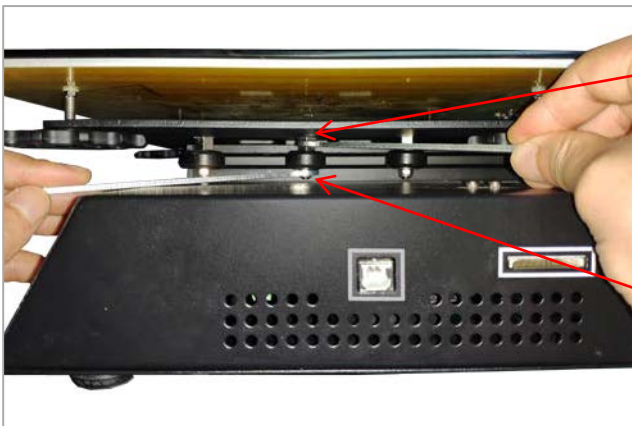

① Fix the nut with a 8mm opening wrench.

Installation

1. Install frame

(1) Take off the screw on one side of the fixture, and then fix the fixture to the frame with the screw, as shown below. Check the screws on both sides of the fixture to make sure the screws are tightened.

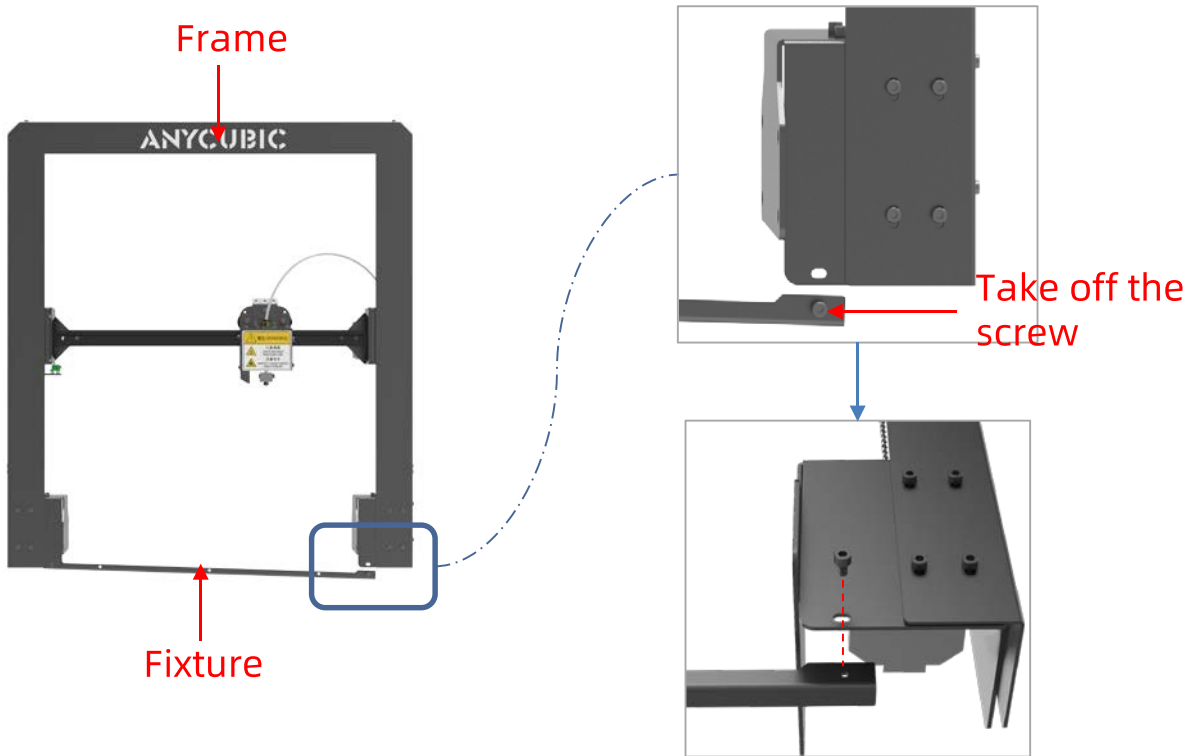

(2) Carefully lift the base to fit into the frame and fix them by 8 pieces of M5*8 screws as shown below. Fasten the screws when all the screws are pre-installed.

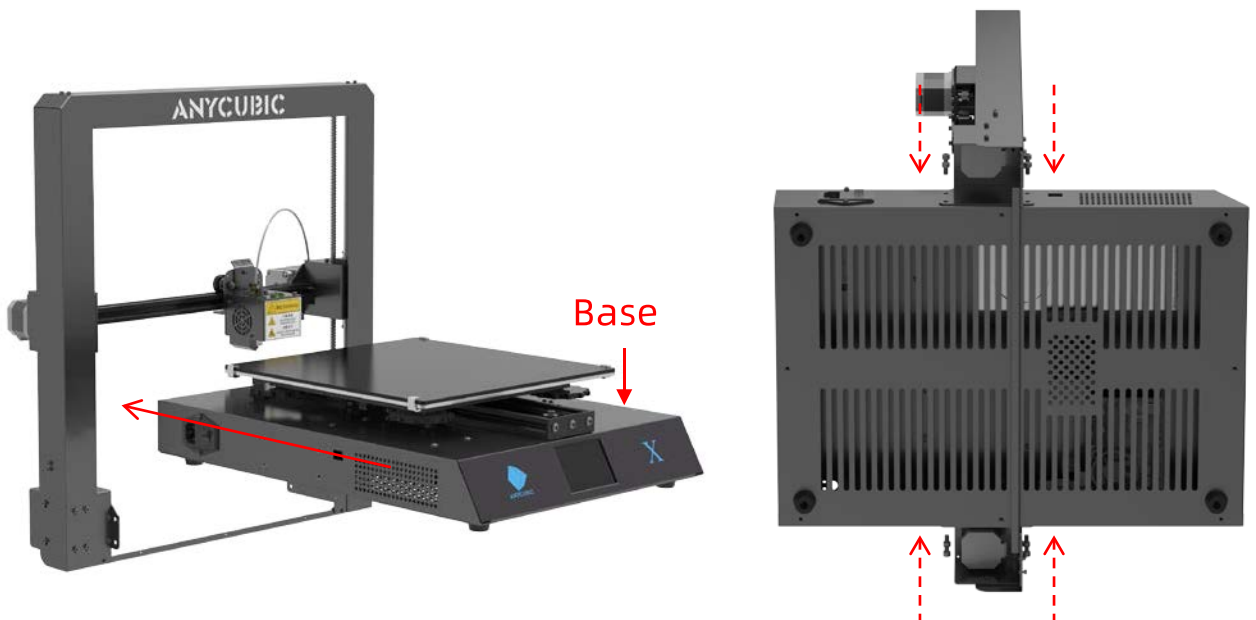

Installation

(3) Take off two screws of the frame and then install the holder of the filament sensor to the frame with the two screws.

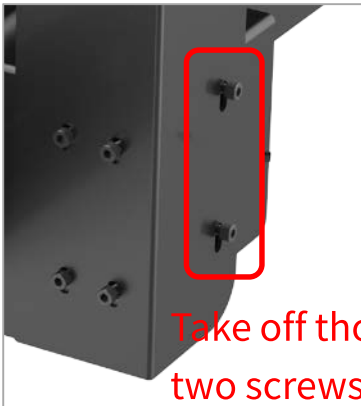

Take off those two screws

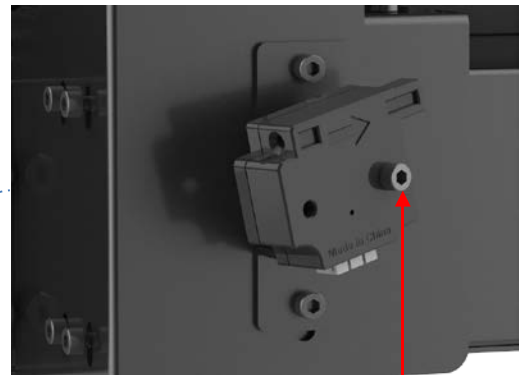
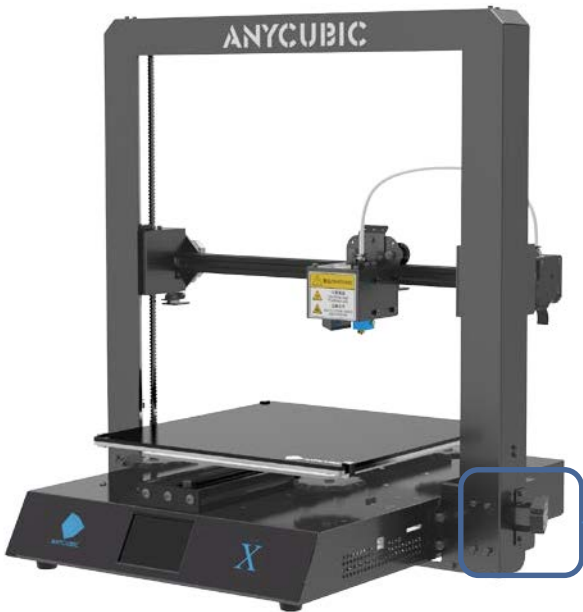
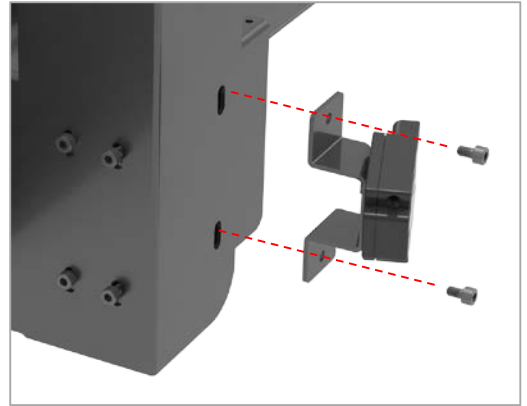

Adjust the direction of filament sensor to allow filament feeding smoothly, and then tighten the screw.



Pay attention to the direction of the holder

Installation

(4) Use two M3*5 screws to install the filament holder, then loosen the two screws on the lower right side of the frame, until the filament holder could be installed, and then tighten those two screws.

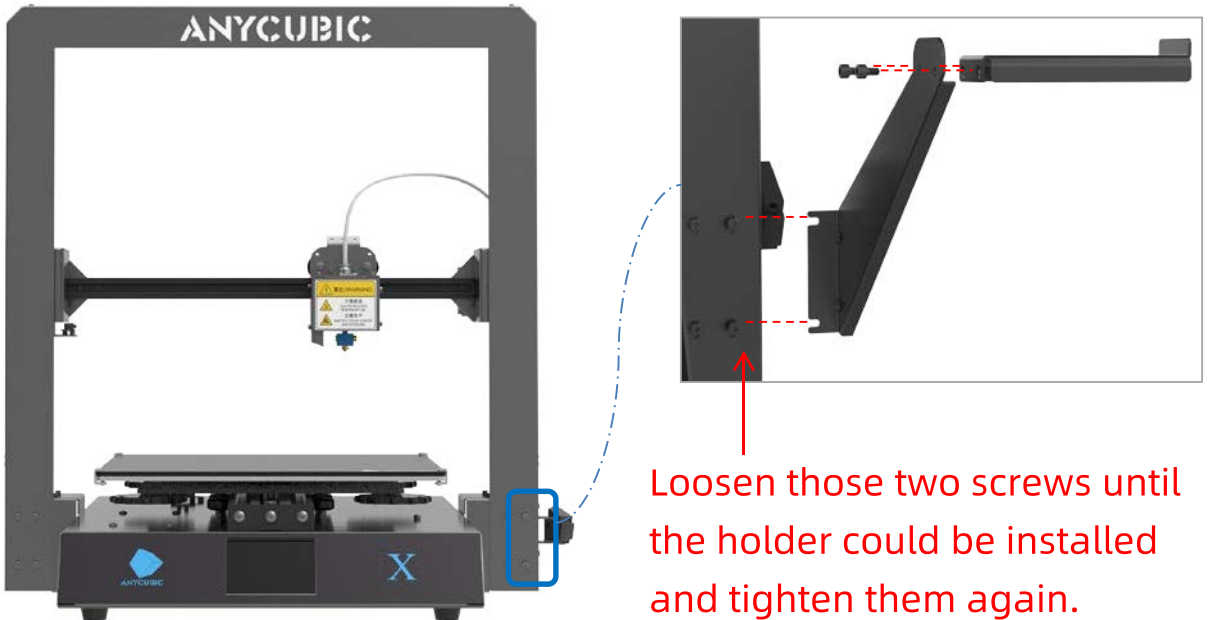

2. Wiring

(1) Select the correct voltage mode according to your local voltage ratings (110V/220V). The switch is inside the bottom left of the base and 220V is default. Allan keys can be used to move the switch inside.

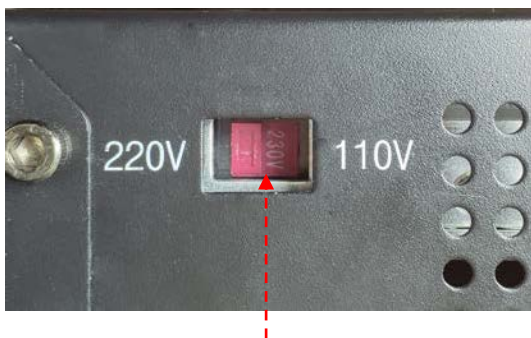

In some cases, 220V labeled as "230" , 110V labeled as "115"

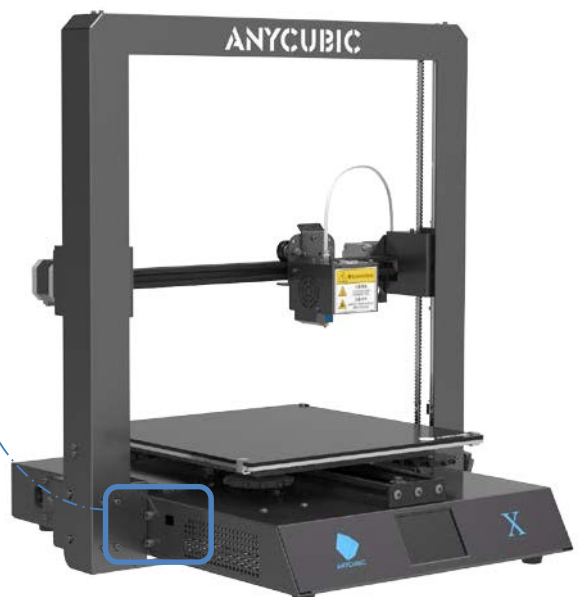

Installation

(2) There are 3 ports with different color (Red/Green/Black) at the bottom right side of the base, and there are 3 different color cable connectors respectively. Accordingly, insert those connectors to the ports by the same color. Then insert the filament sensor wire to the corresponding port of the filament sensor.

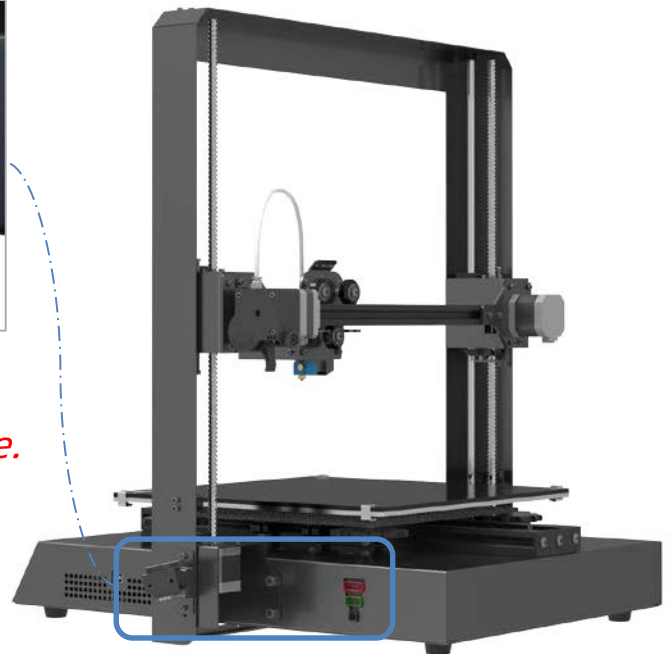
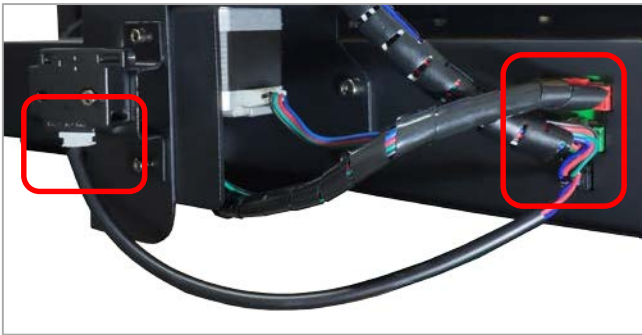

*> Make sure the connectors are well inserted, and no pins are bent inside.
> Wrong or loose connection would lead to malfunction of the machine.*

(3) Customers may notice there is a ring of zip tie attached just below the plastic ring of the quick connector. **Do not cut it off.** Only cut this zip tie when swapping or repairing the hotend.

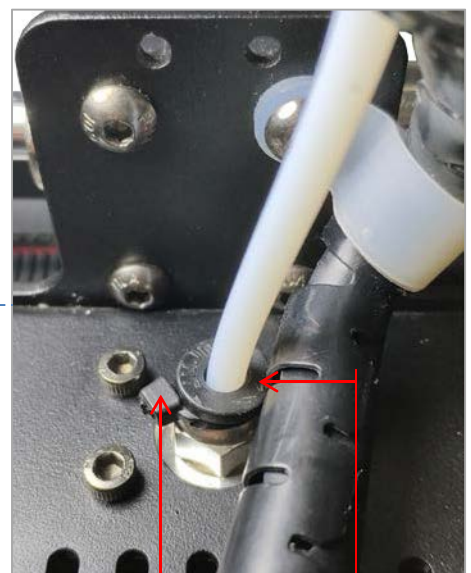
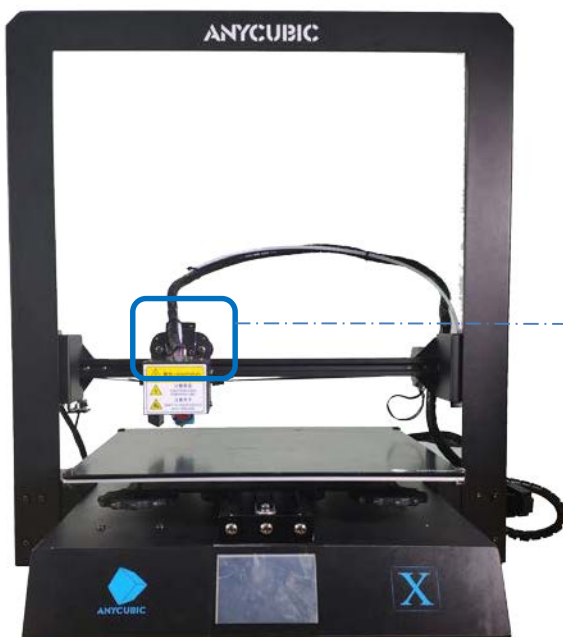

Zip tie Plastic ring

Leveling

It is essential to level the print platform of a 3D printer. Once leveled, it is not necessary to level every time before each prints. Please follow the procedures below:

1. Manual Leveling

Step 1. Plug in the power cord and power on the printer.



Step 2. On the "Home Menu", click "Tools"-->"Home"-->"Home Z". Lock the Z axis to prevent the Z axis from falling during leveling.

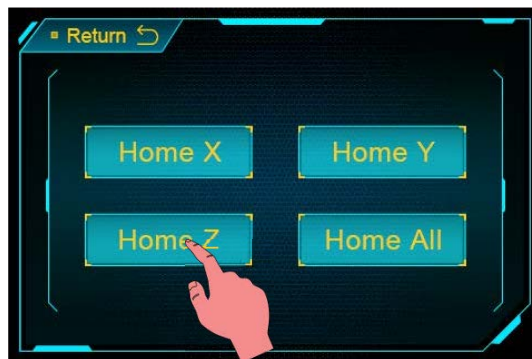

Step 3. Place the leveling paper (included on top of the printing platform) on the lower left corner of the printing platform, as shown below.

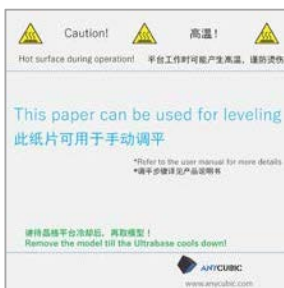

Leveling paper

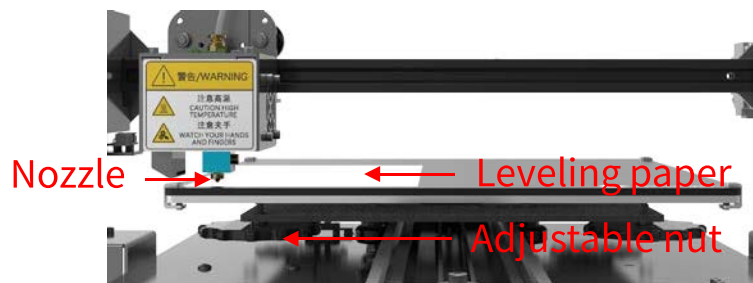

Leveling

Step 4. Manually move the printing head and platform to the point ①. Tighten or loosen the adjustable nut underneath the printing platform to adjust the distance between the nozzle and the platform to about the thickness of the paper (~0.1-0.2mm, the nozzle just touches the paper), as shown below. You need to adjust the adjustable nut until you feel the drag resistance when pulling the paper back and forth. (Note: "feel the drag resistance" means the paper can be moved, but with resistance)

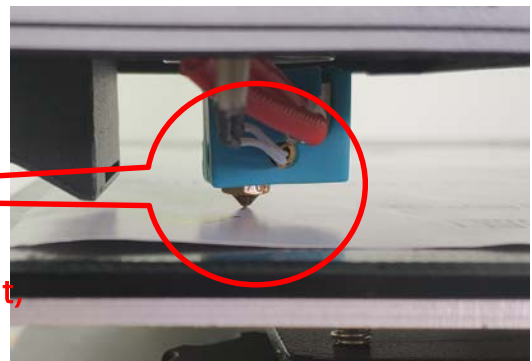
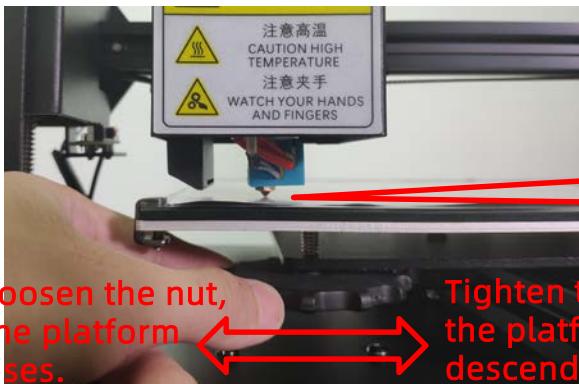
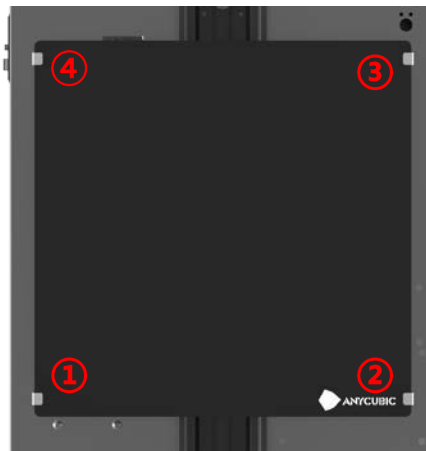

Loosen the nut, the platform rises.  Tighten the nut, the platform descends.

Note: Do not press on the platform when adjusting the nut, otherwise it will be affecting the leveling accuracy.

Leveling

Step 5. Follow step 4 to level the other three corners (②→③→④), as shown below. You need to adjust the 4 points of the platform 2 or 3 times to ensure leveling result is OK, otherwise the platform could be scratched.

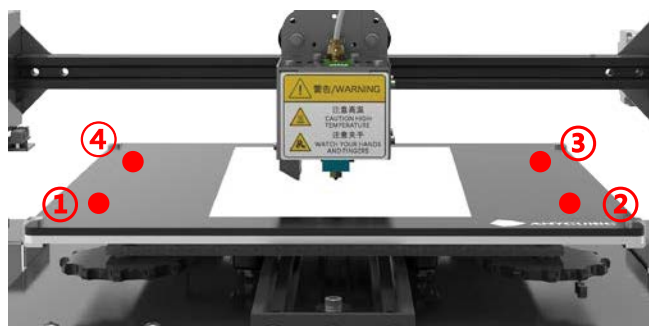

Step 6. Move the printing head and platform at the same time, so that the printing head can be moved in diagonal order, as shown below. In the process of moving, check whether the distance between nozzle and printing platform is about a piece of paper thin or not. You may need to adjust the 4 points of the platform 1 or 2 times to check the leveling result.

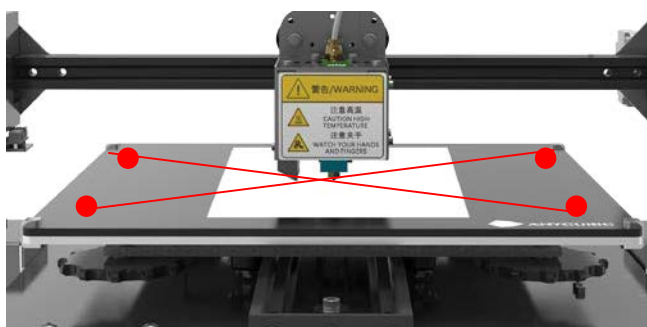

Note: Do not let the nozzle rub against the printing platform directly during the whole leveling process. When moving the nozzle, paper must be placed on the platform to prevent the platform from being scratched by the nozzle.

Tips: The printing platform has the characteristics of high temperature resistance, long service life, good adhesion and easy removal of prints. Its flatness is in the range of 0~0.2mm variation, means every piece of the platforms has been tested by a 0.2mm feeler gauge on a flat marble table.

Leveling

2. Supplements to leveling

In some rare cases, after "Home All", the nozzle can be still much lower than the platform, even after fully tighten the 4 nuts underneath. On the opposite, sometimes the nozzle is still too high from the platform, even after fully loosen the 4 nuts underneath.

How to solve this: adjust Z adjustable nut. At both ends of X axis, there is a Z adjustable nut. The lower tip of Z adjustable nut can trigger the Z end stop when Home (going down), and 'tell' the machine Z axis is getting to zero and stop moving.

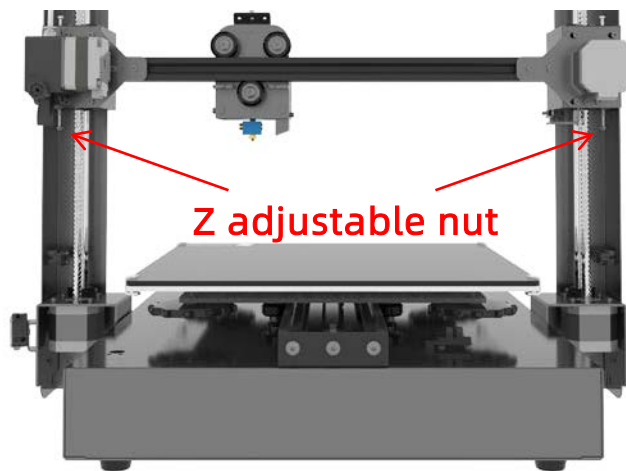

(1) Raise the nozzle by click "Tools"-->"Axis"-->"10" on +Z column, adjust the 4 nuts under the platform, let the height in-between the support plate and the heated bed is ~15mm for all the 4 corners.

Leveling

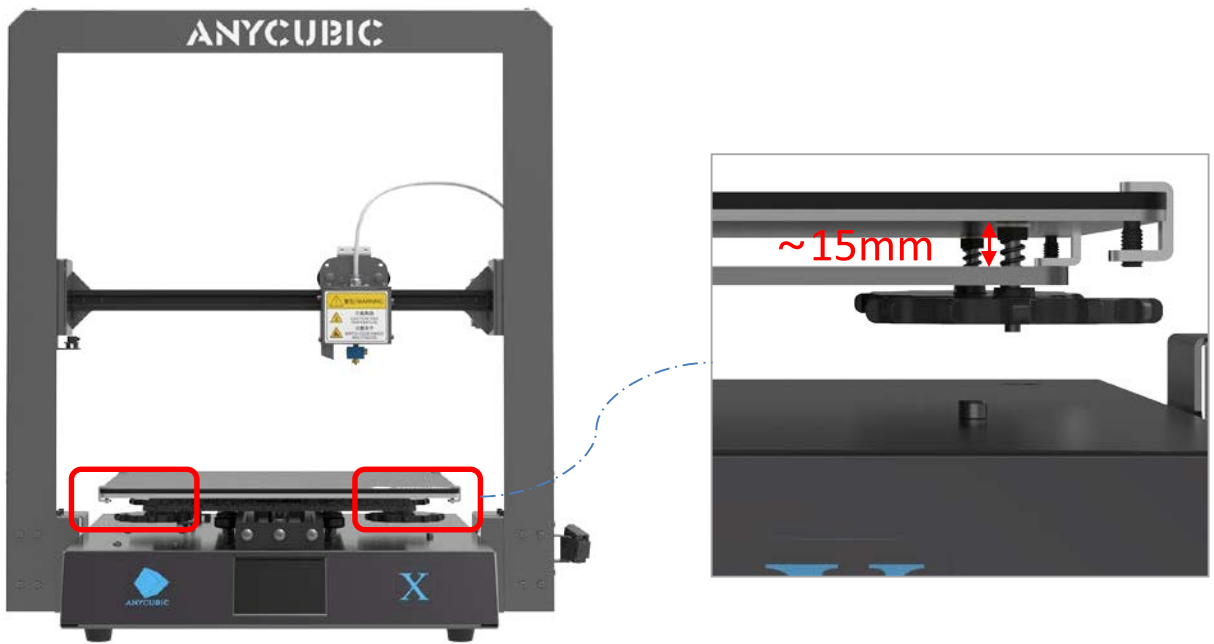

(2) Tighten Z adjustable nut by X mm if nozzle is lower than the platform (X is defined by how much the nozzle is under the platform), while loosen it by Y mm if nozzle is too high from the platform (Y is defined by how much the nozzle is above the platform). It may need adjustment for few times.

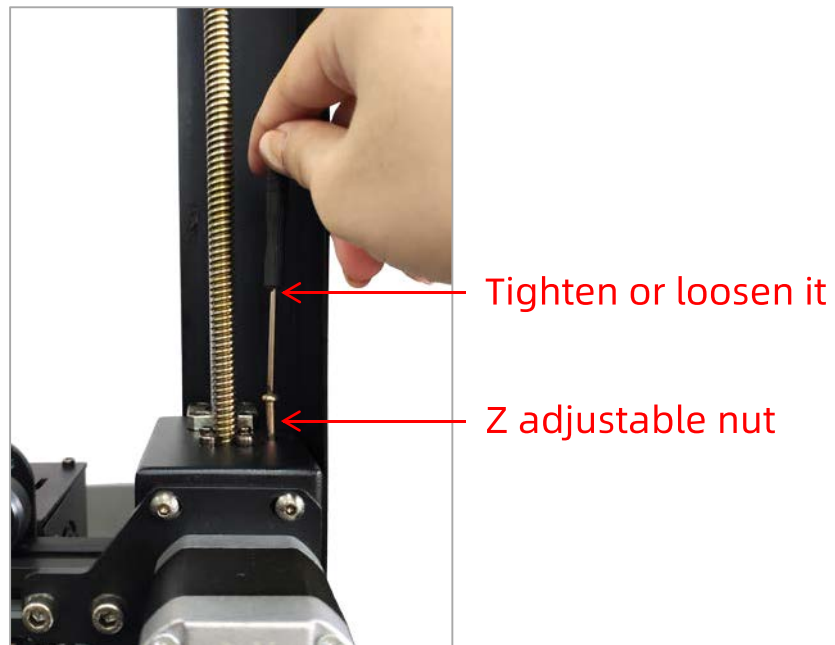

(3) Click "Tools"-->"Home"-->"Home all" to verify the results. After this, please level the platform again as described above.

Printing test

1. Filament in

(1) Step 1. Return to the home menu, click "Tools"→"Axis"→"10+Z" 10 times to rise the print head.



(2) Place the filament on filament holder, please note the direction of filament. Click "Tools"→ "Filament"→ "Filament in", and the interface as shown in the figure below will pop up, click "OK". Straighten the end of filament, pass the filament through filament sensor, and then press the handle on the extruder and push the filament in until it just goes in the white Teflon tubing.

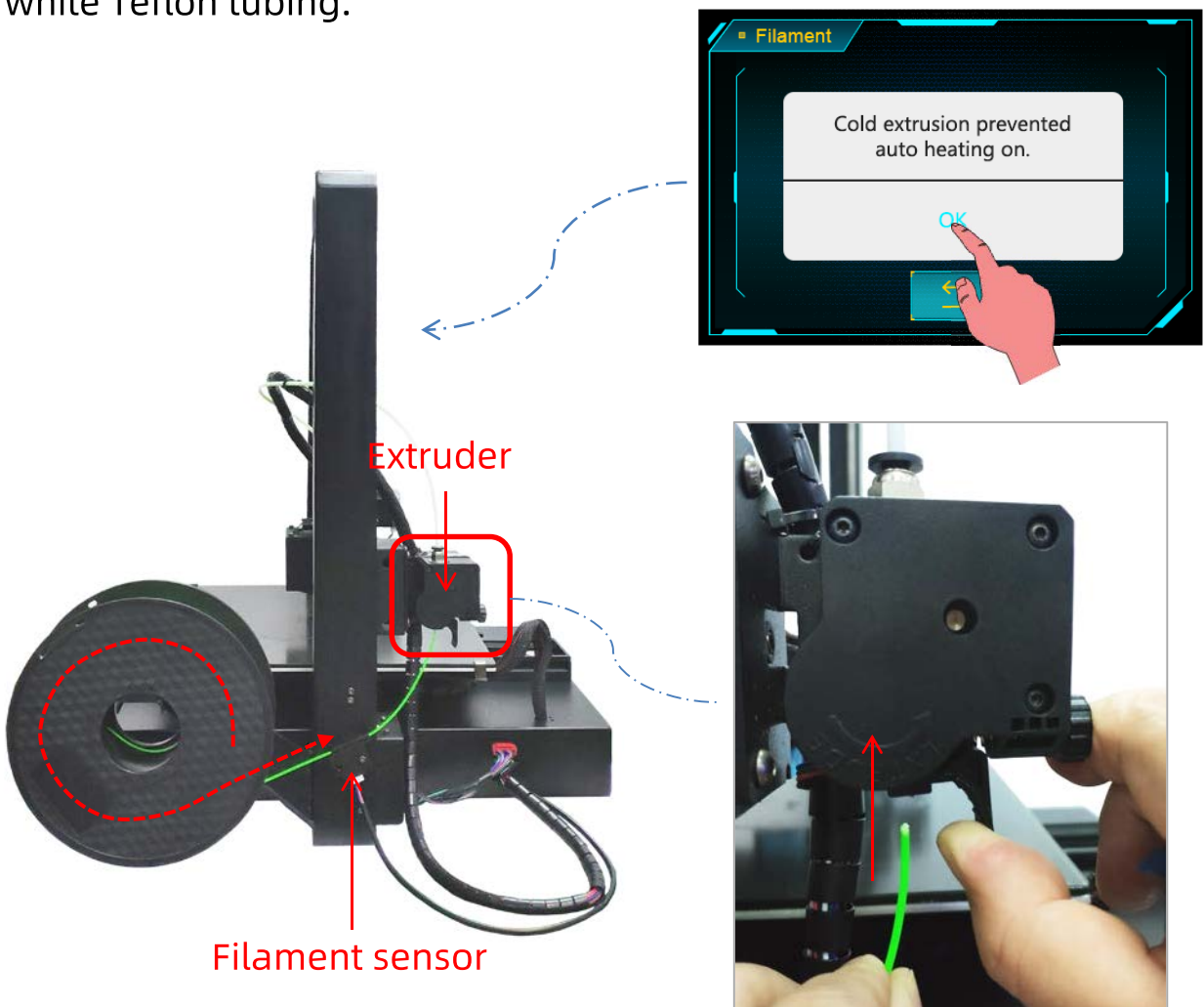

Printing test

(3) When the nozzle reaches to the target temperature (i.e. 230°C), click “Filament in” **again**, the filament would be automatically fed in by the extruder and it would be melted through the nozzle. Now, click “STOP”. You may use tweezers to clean the filament residue on the nozzle tip.

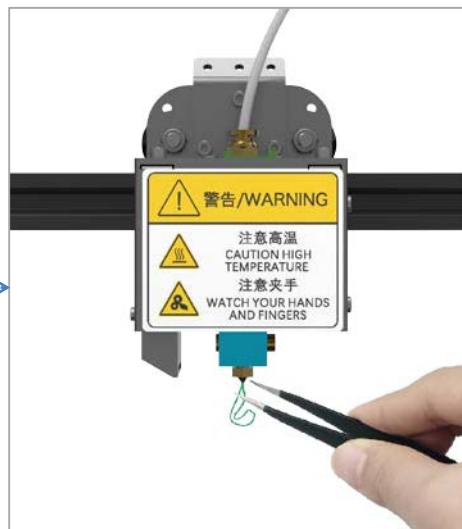
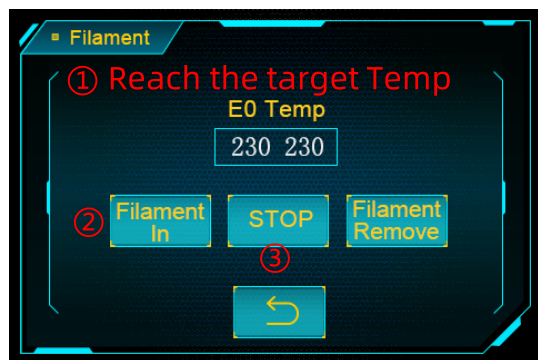

Note: During feeding, if the melted filament is not smooth or too thin, please adjust the extrusion force by rotating the knob as shown below.

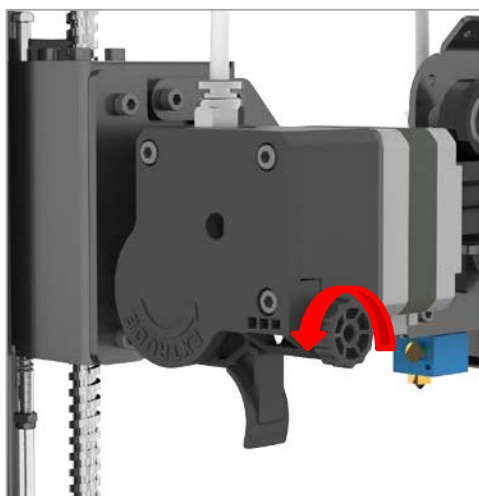

If the melted filament is not smooth, please increase the extrusion force by rotating counterclockwise

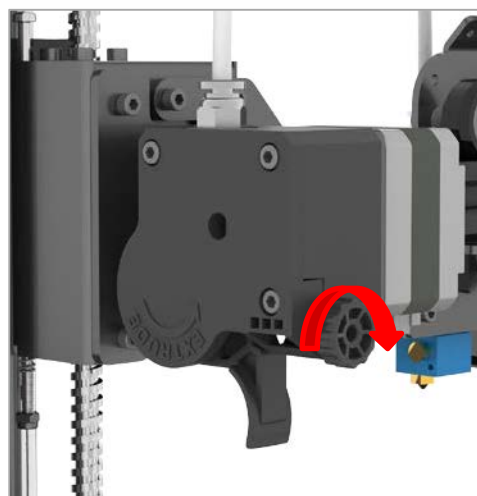

If the melted filament is too thin, please reduce the extrusion force by rotating clockwise

Printing test

2. Print test

Insert the memory card into the memory card slot at the base. Click on the Home Menu "Print" to enter the file list. There is a printable test file included -- "owl_pair" (author: etotheipi, www.thingiverse.com). Single click on "owl_pair", and click "Print". The machine will be automatically heating the platform and nozzle before printing.



There might be 3 kinds of results for the first layer of the test prints.

A: Nozzle too close, lack of extrusion, the nozzle rub against the platform. Slowly tighten the corresponding nuts underneath by half circle or level again.



Nozzle too close

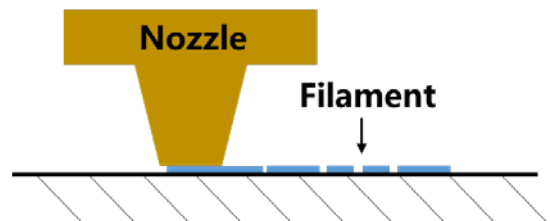

B: Proper nozzle height, good extrusion and adhesion.

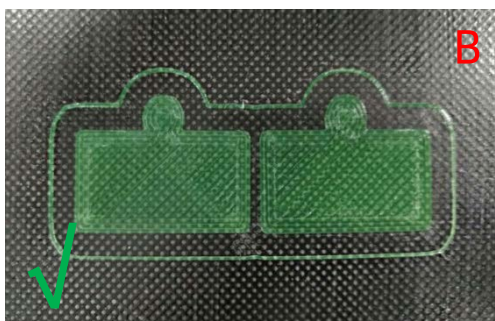

Proper nozzle height

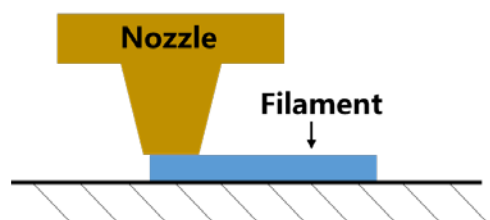

Printing test

C: Nozzle too high, Large gap, filaments are not even adhere to the platform. Slowly loosen the corresponding nuts underneath the platform by half circle or level again.

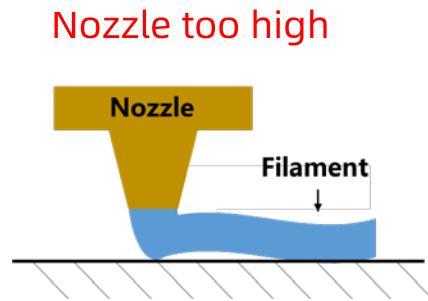
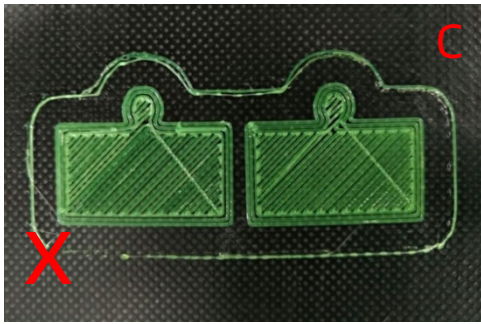

If you can't improve the model printing effect by fine-tuning the adjustable nut in the printing, please click "STOP" on the screen, return to the Home Menu, and click "Tools" → "Axis" to raise the Z axis by 10mm. Then use a spatula to shovel the model and level the platform again as described above.

Driver installation

There are two operational mode for Mega X : print offline and print online.

Print offline: As shown previously, after insert memory card, platform leveled, click “Print” on the display and print a selected file (GCode files ONLY).

Print online: Install CP2102 driver to bridging PC and machine, and install Cura for slicing and control the machine to print via data cable.

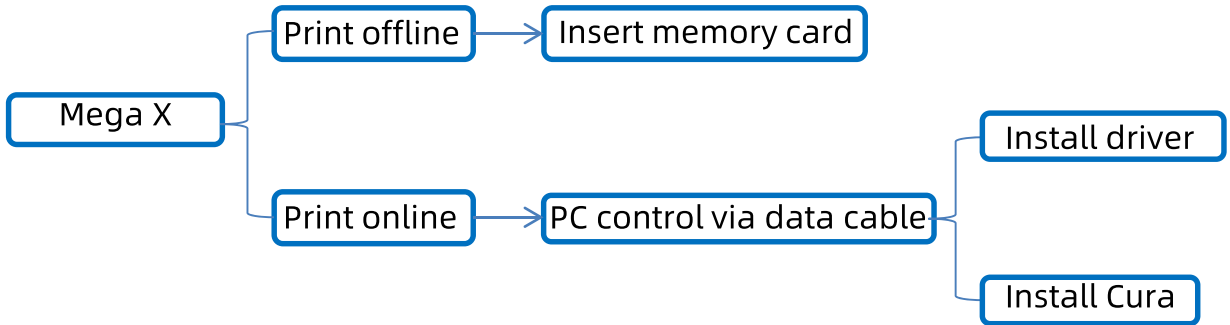

It is suggested to use **Print Offline** mode to minimize the noisy signal via data cable.

How to install the software to enable PC control (print online).

First, turn on the machine, connect the printer (data cable port) and your PC via data cable. Mega X uses CP2102 chip for communication.

The CP2102 driver may not be installed automatically, so it is required to check that. Right click “This PC” → “Properties” → “Device manager”, if there is an exclamation mark as shown below, then it needs to be installed manually.

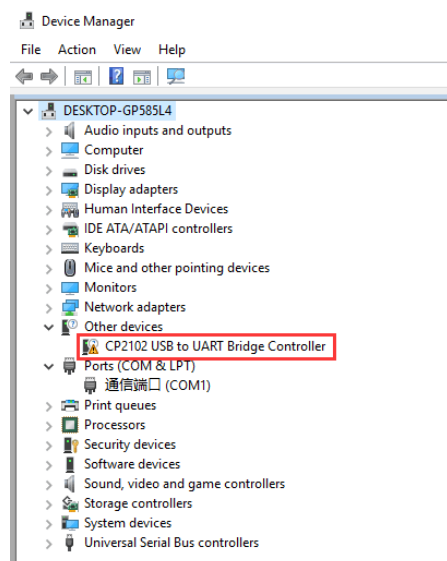

Driver installation

CP2102 driver files are located in the memory card (or visit our website to download). "Files_English_MEGA X"→"Driver_CP2102"→"Windows" ("CP210xVCPInstaller_x64" is for 64 bit system and "CP210xVCPInstaller_x86" is for 32 bit system). Here Windows 7 64 bit PC is taken for example:

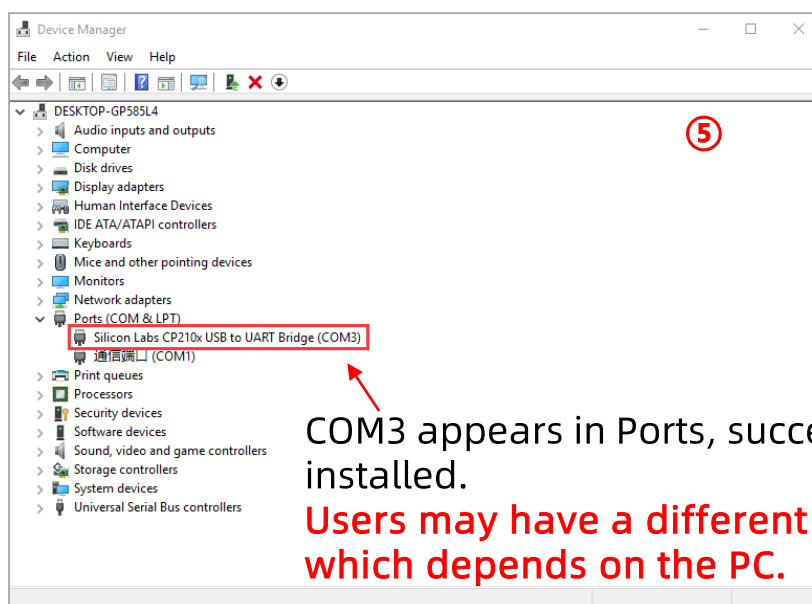
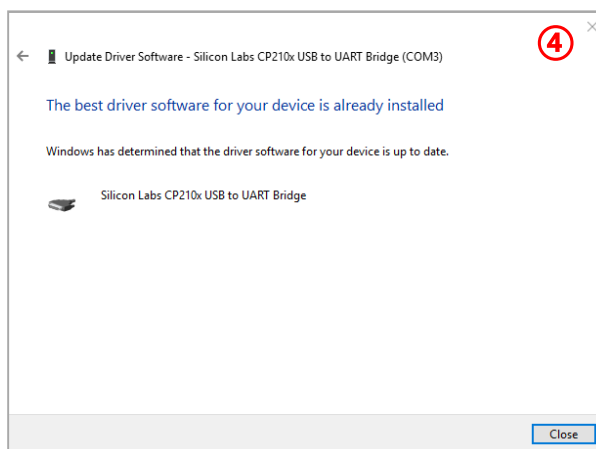
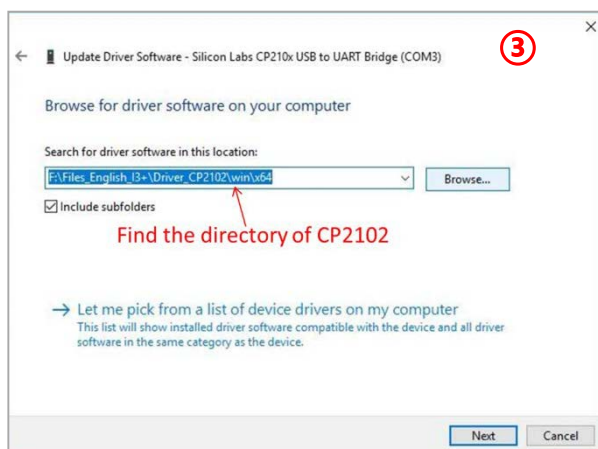
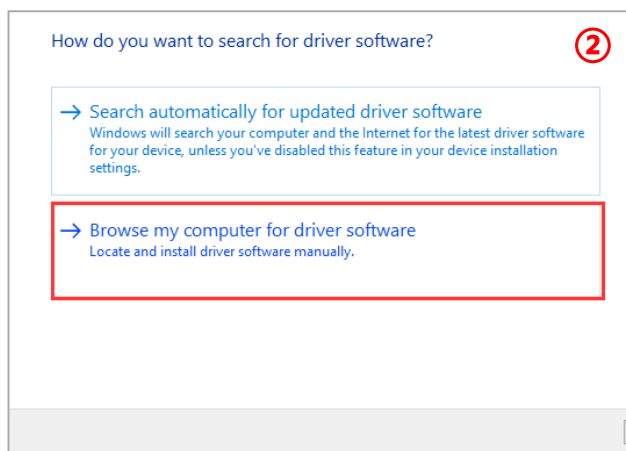
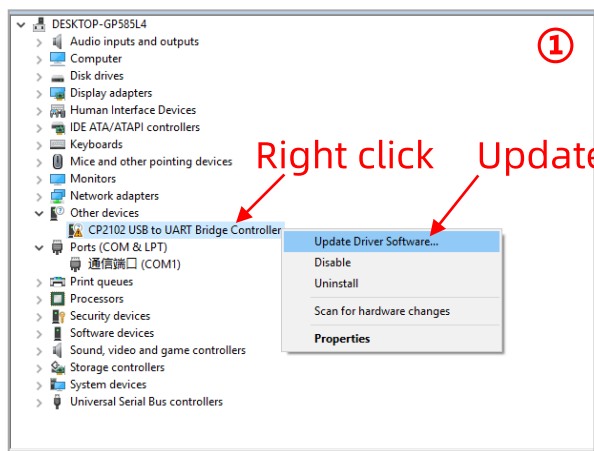

Introduction to slicing software

Introduction of slicing software: ①Cura installation, ②Machine settings, ③Import the configuration file , ④ Manipulate 3D model in Cura, ⑤Slice and preview, ⑥Print online, ⑦Print offline

1. Cura installation

3D printer reads Gcode file and prints. It is necessary to convert 3D files (such as stl file) into Gcode files for machine to recognize. Software that convert 3D files into Gcode files is called slicing software.

Ultimaker_Cura-4.2.1-win64 is used for example here (Users may use their own slicer software). It is located in memory card→“ Files_English_Mega X”→ “ Cura”→ “ Windows”. Double click “Ultimaker_Cura-4.2.1-win64.exe”, and follow the steps as shown below.

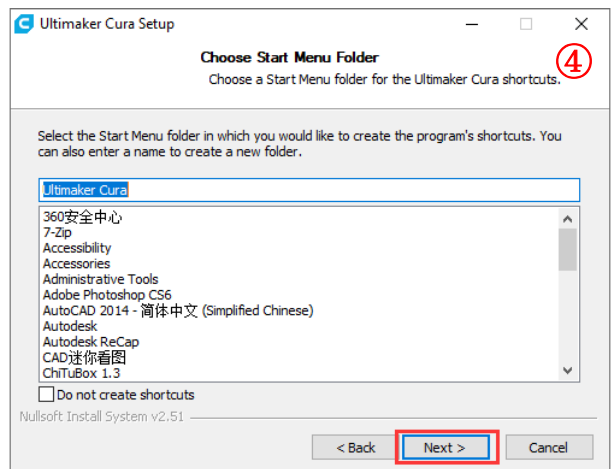
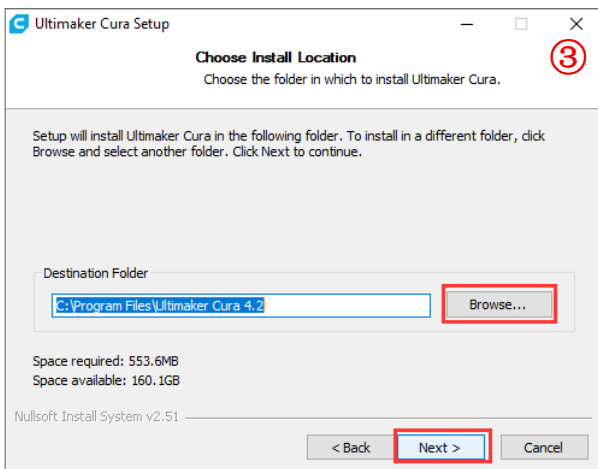
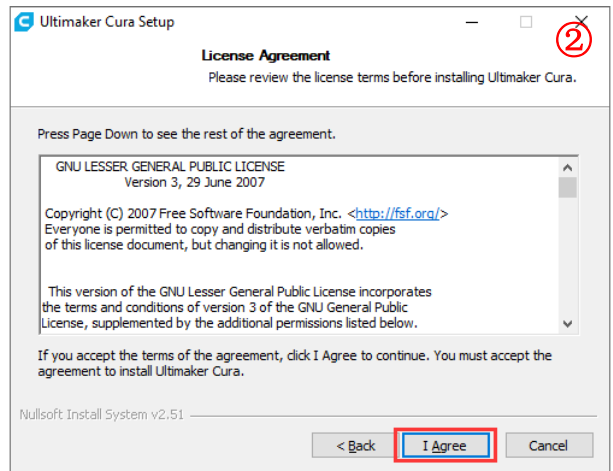
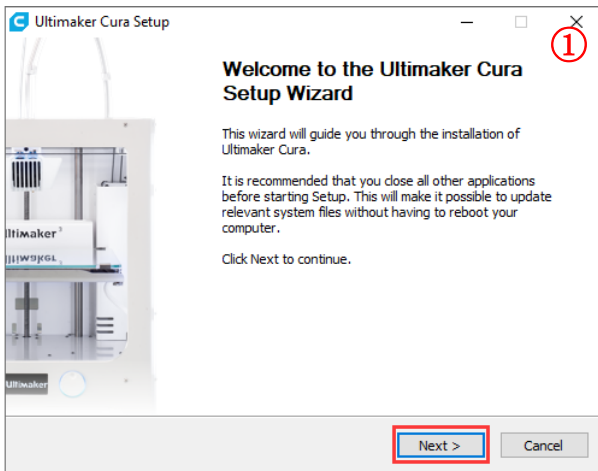

Introduction to slicing software

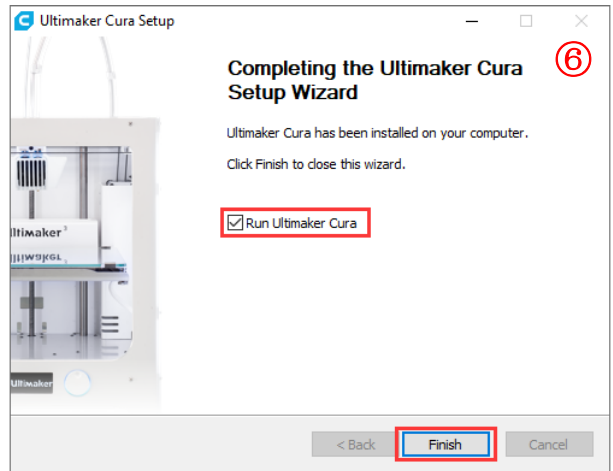
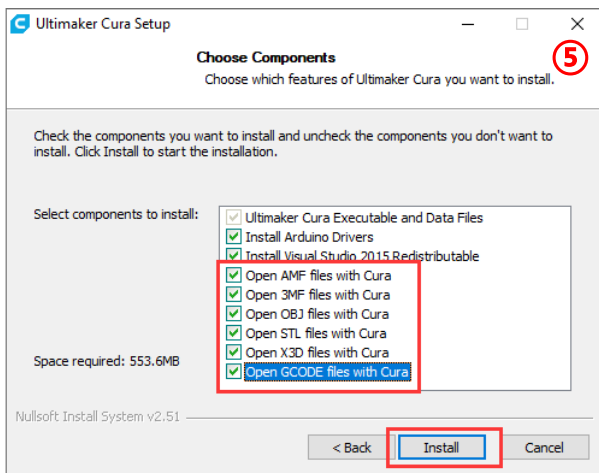

Note: Printing online requires the installation of a driver, as shown below. If you don't print online, you don't need to install it.

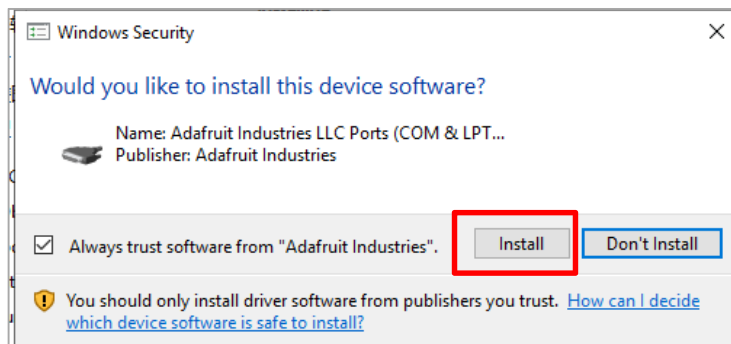

2. Machine settings

Upon completion of installation, the first launch of the software will display the following welcome screen. Click "Get started" to start the machine settings.

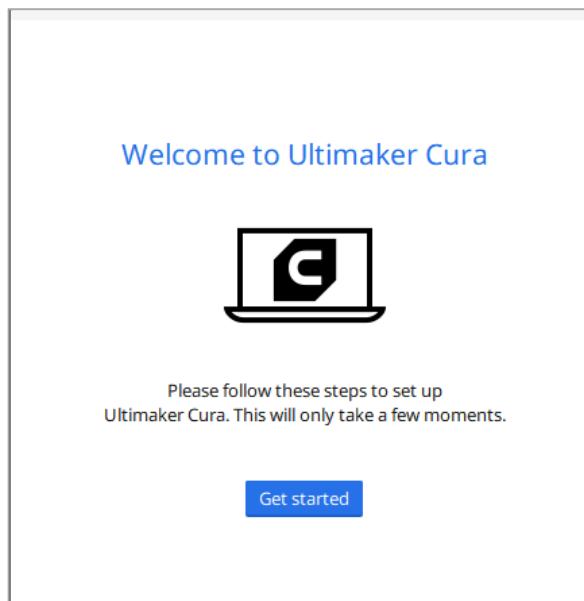

Introduction to slicing software

①

User Agreement

Disclaimer by Ultimaker

Please read this disclaimer carefully.

Except when otherwise stated in writing, Ultimaker provides any Ultimaker software or third party software "As is" without warranty of any kind. The entire risk as to the quality and performance of Ultimaker software is with you.

Unless required by applicable law or agreed to in writing, in no event will Ultimaker be liable to you for damages, including any general, special, incidental, or consequential damages arising out of the use or inability to use any Ultimaker software or third party software.

Decline and close

Agree

②

What's new in Ultimaker Cura

4.2.0

Orthographic view.

When preparing prints, professional users wanted more control over the 3D view type, so this version introduces an orthographic view, which is the same view type used by most professional CAD software packages. Find the orthographic view in View > Camera view > Orthographic, and compare the dimensions of your model to your CAD design with ease.

Object list.

Easily identify corresponding filenames and models with this new popup list. Click a model in the viewport and its filename will highlight, or click a filename in the list and the corresponding model will highlight. The open or hidden state

Next

③

Help us to improve Ultimaker Cura

Ultimaker Cura collects anonymous data to improve print quality and user experience, including:

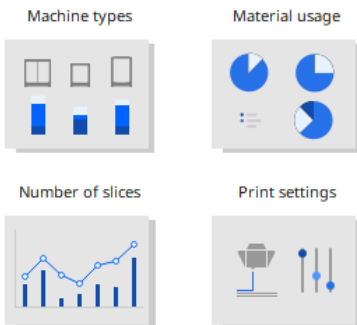

Data collected by Ultimaker Cura will not contain any personal information. [More information](#)

Next

④

Add a printer

Add a networked printer

There is no printer found over your network.

Refresh

Add printer by IP

Troubleshooting

Add a non-networked printer

Next

⑤

Add a printer

Add a networked printer

Add a non-networked printer

- ▼ Anycubic
 - Anycubic 4Max
 - Anycubic Chiron
 - Anycubic i3 Mega
- > Ateam Ventures Co. Ltd.
- > BEEVERYCREATIVE
- > BFB
- > BIBO
- > BQ
- > Builder
- > Cocoon Create

Printer name Anycubic i3 Mega

Next

⑥

Ultimaker Cloud



The next generation 3D printing workflow

- Send print jobs to Ultimaker printers outside your local network
- Store your Ultimaker Cura settings in the cloud for use anywhere
- Get exclusive access to print profiles from leading brands

Create an account

Sign in

Finish

Introduction to slicing software

According to the wizard, we have selected the "Anycubic i3 Mega" model. Now, we will set the model parameters of Mega X based on that model.

(1) Click "Manage printers", as shown below.

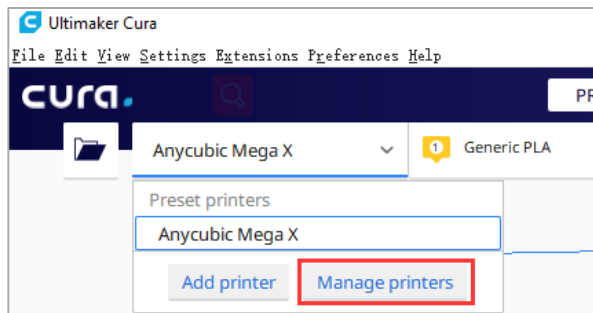

(4) Click "rename" to change the machine name to "Anycubic Mega X", and then click "Machine Settings" .

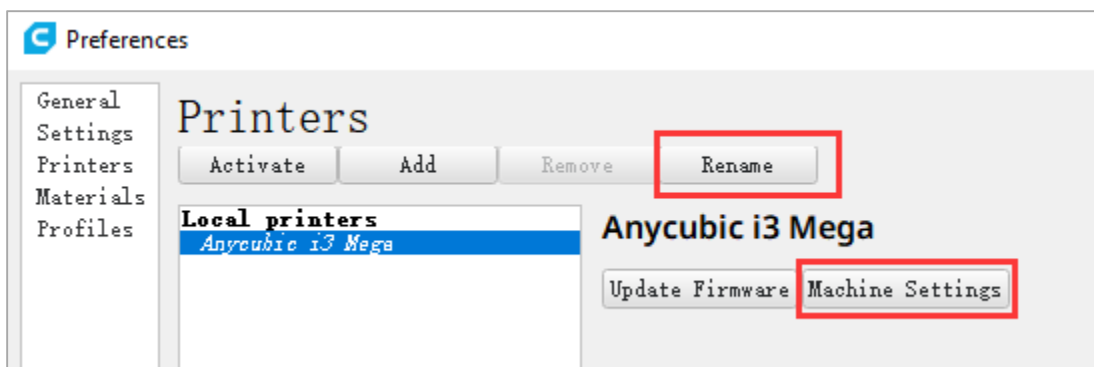

(5) Modify the "XYZ" parameters as 304, 304 and 306 respectively on the "Machine Settings" page, as shown below.

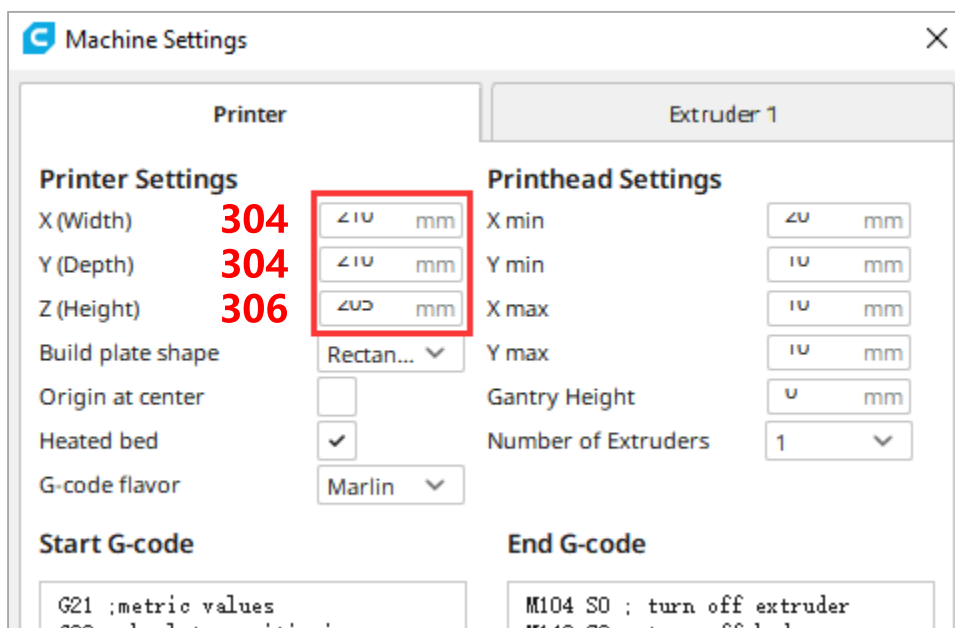

Introduction to slicing software

3. Import the configuration file

After continuous testing, we provided users the best printing parameters of different filaments for Mega X, allowing them to directly import the parameter files from the memory card into the software.

(1) Click "Settings"- "Configure setting visibility...", and then check "Check all" to make all Settings visible.

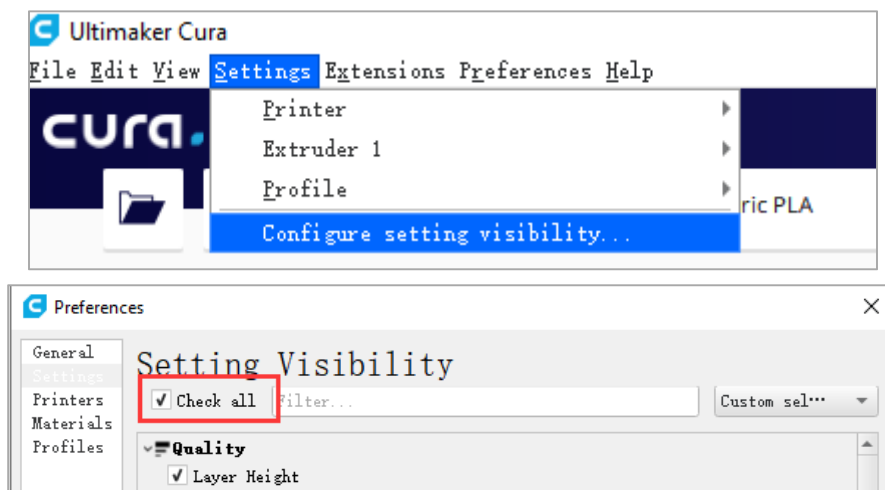

(2) Click "profile" on the left, and then click "import" to open the "import profile" dialog box, then select the "Suggested parameters MEGA X-PLA- V1.0. curaprofile" (file path: memory card → "File _ English _ MEGA X"), and click "open". After successful import, the following success prompt will pop up. Please import the "Suggested parameters MEGA X-TPU- V1.0. curaprofile" file as so.

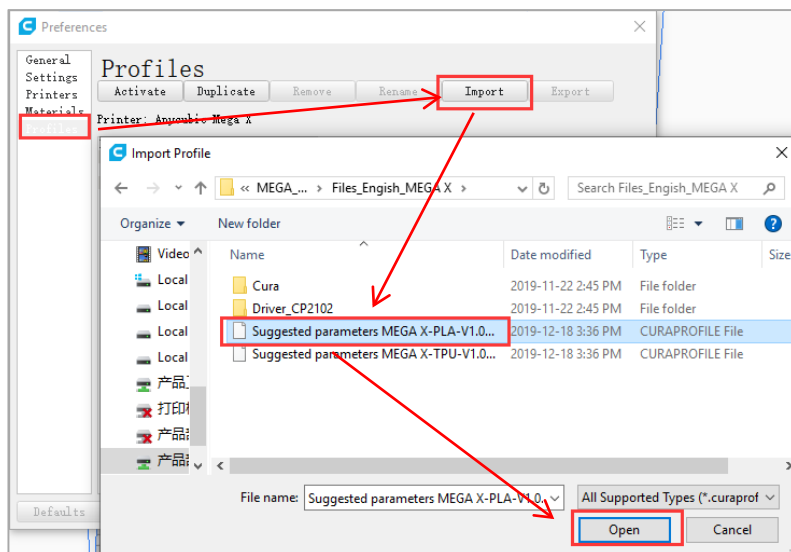

Introduction to slicing software

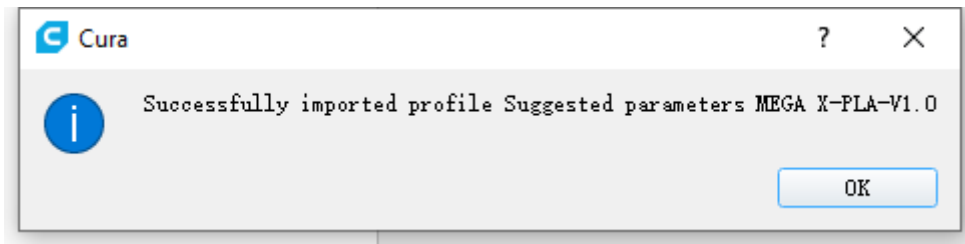

(3) Select the configuration file that you just imported.

Click to open
"Print settings"

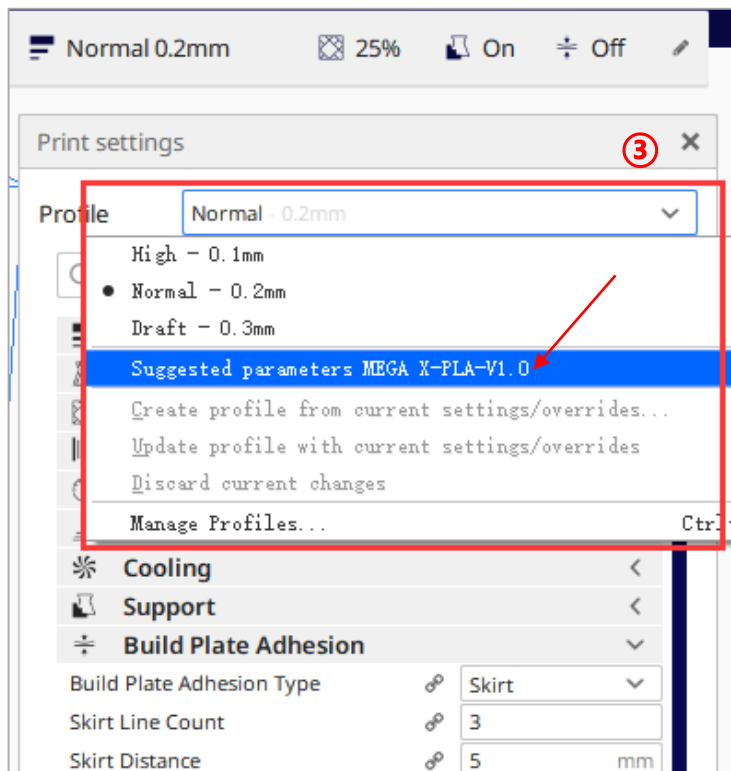
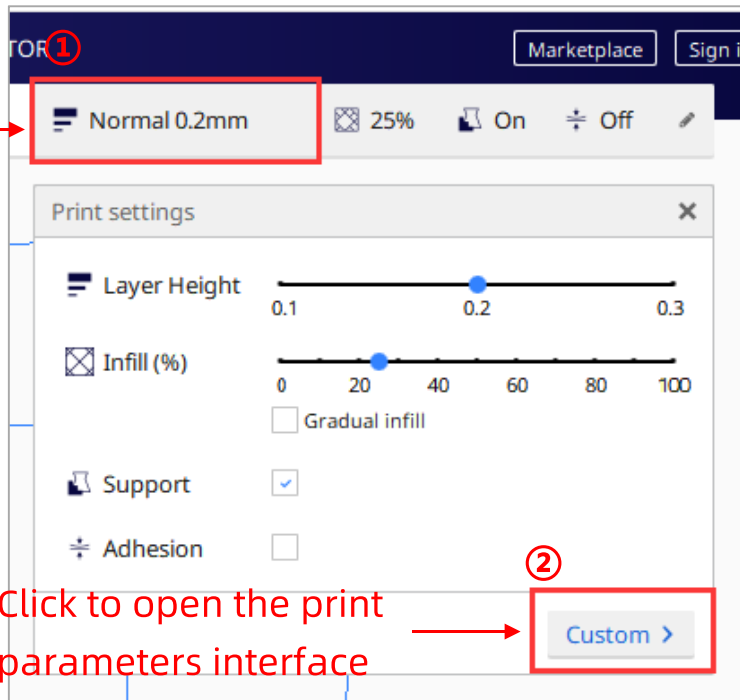

Introduction to slicing software

4. Manipulate 3D model in Cura

In the Cura software interface, click on the "File" → "Open File(s)..." to import your own three-dimensional format model (such as .stl file).

Users can "Rotate" "Scale" "Mirror" the model. As shown below:

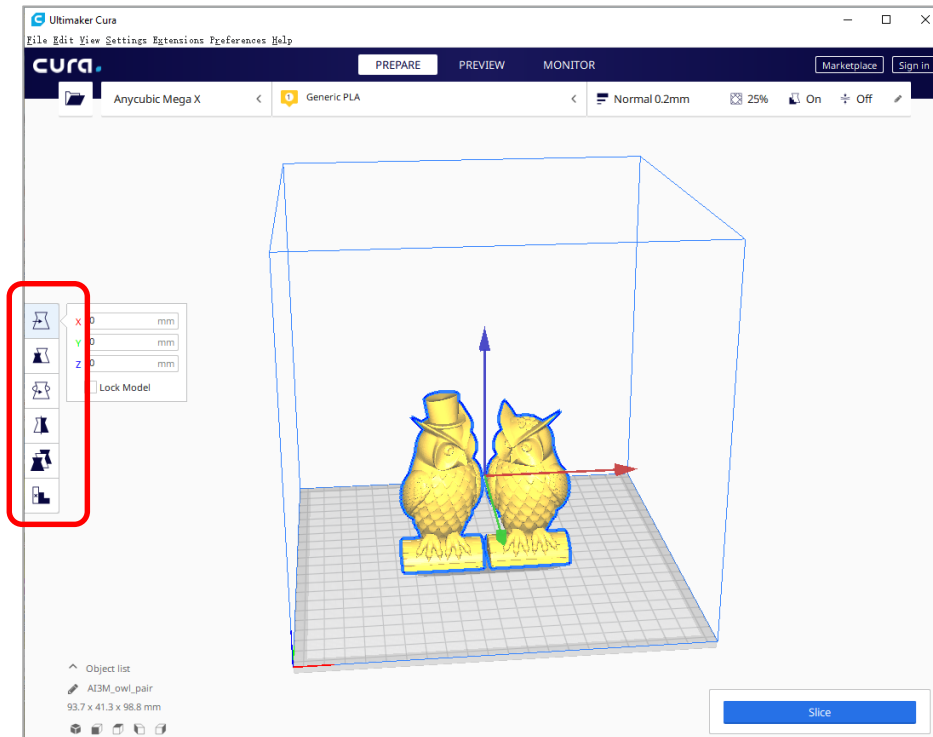

Other operations:

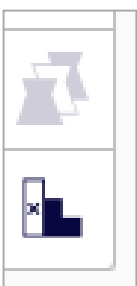

Per Model Settings: When you open multiple models, you can configure a separate slice configuration for the specified model.

Support Blocker(E): Set the mask area on the model so that the support could not be generate on the set area.

After importing the model, users can customize the printing parameters according to individual needs. But the configuration files that we provide are suggested.

Note: "Suggested parameters MEGA X-PLA- V1.0. curaprofile" file is prepared for PLA filament, and "Suggested parameters MEGA X-TPU- V1.0. curaprofile" file is prepared for TPU filament.

Introduction to slicing software

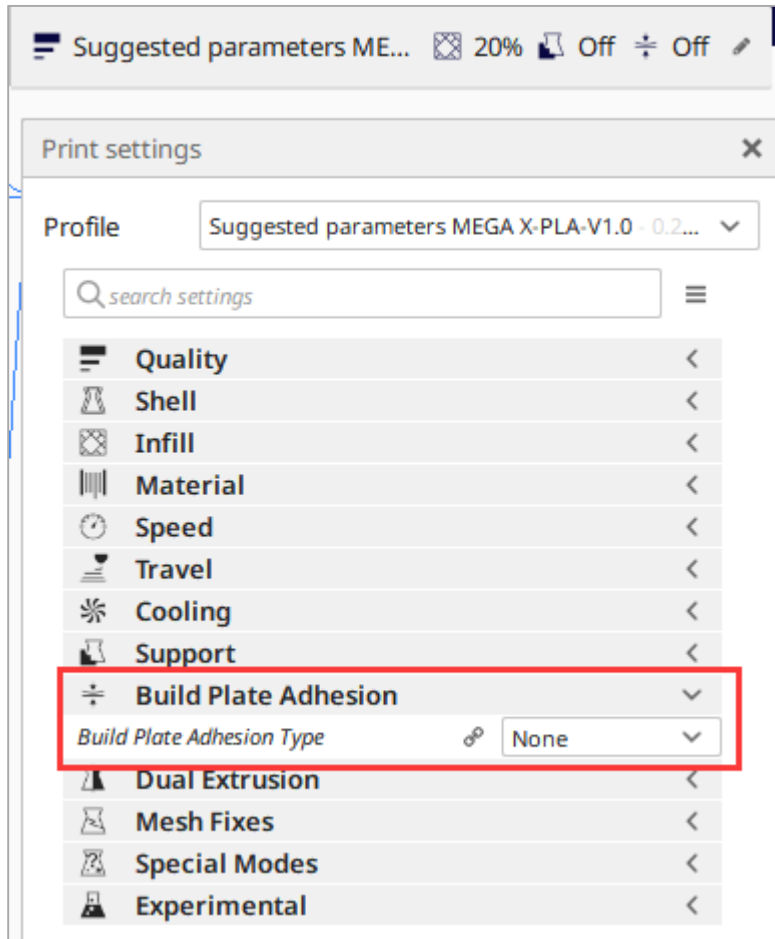

Note: The “Build Plate Adhesion” parameter needs to be set to “None” when printing the maximum size model.

5. Slice and preview

After setting the printing parameters, click the "Slice" button in the lower right corner of the software. After the Slice is finished, click the "preview" button to preview the simulated printing effect in the preview view.

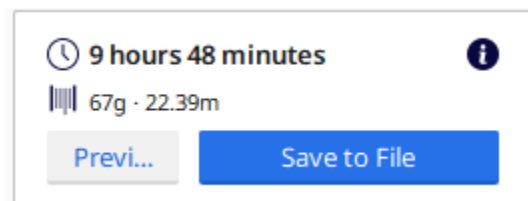
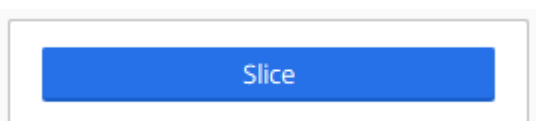

Introduction to slicing software

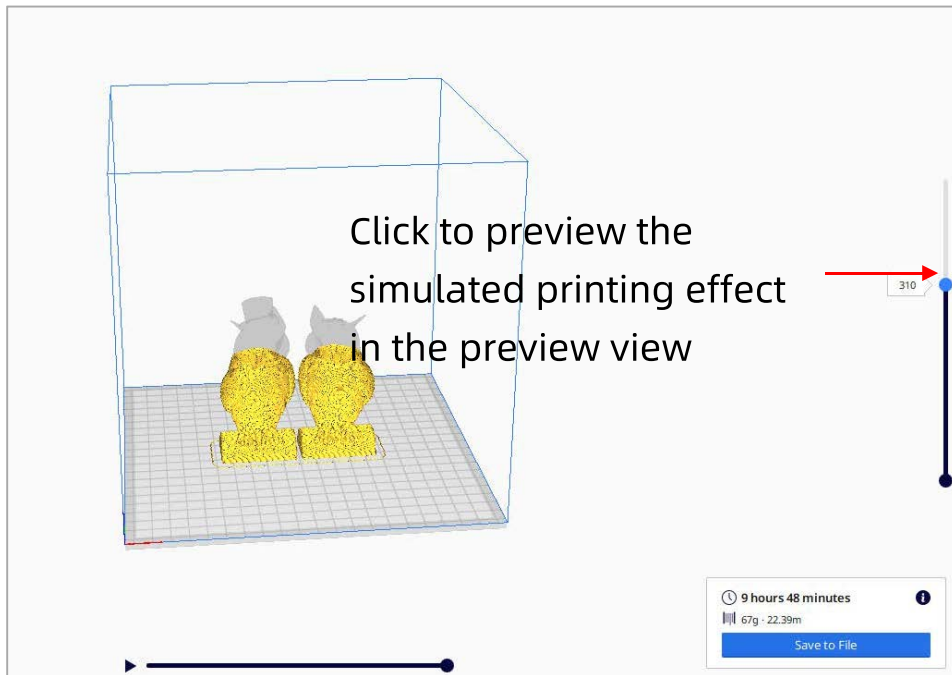

6. Print online

After the parameters have been set up, you can print online via Cura. Click the "MONITOR" button on the main interface. If the printer is not connected properly, the interface will be blank.

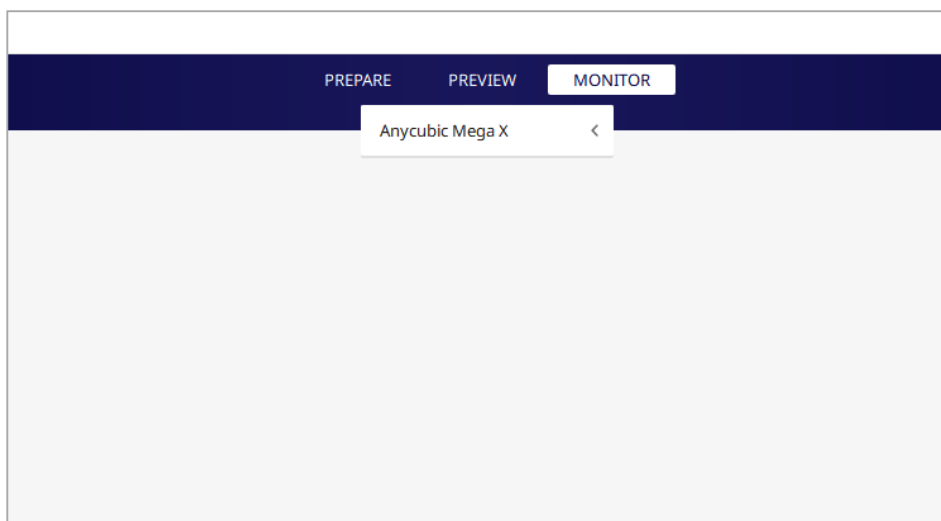

After connecting the data line, Cura will automatically connect to the printer. After waiting for more than ten seconds, the operation panel will be displayed on the right side of the interface. User can control printer through the operation panel. **(In the process of printing, do not plug the data line, or it will interrupt the printing)**

Introduction to slicing software

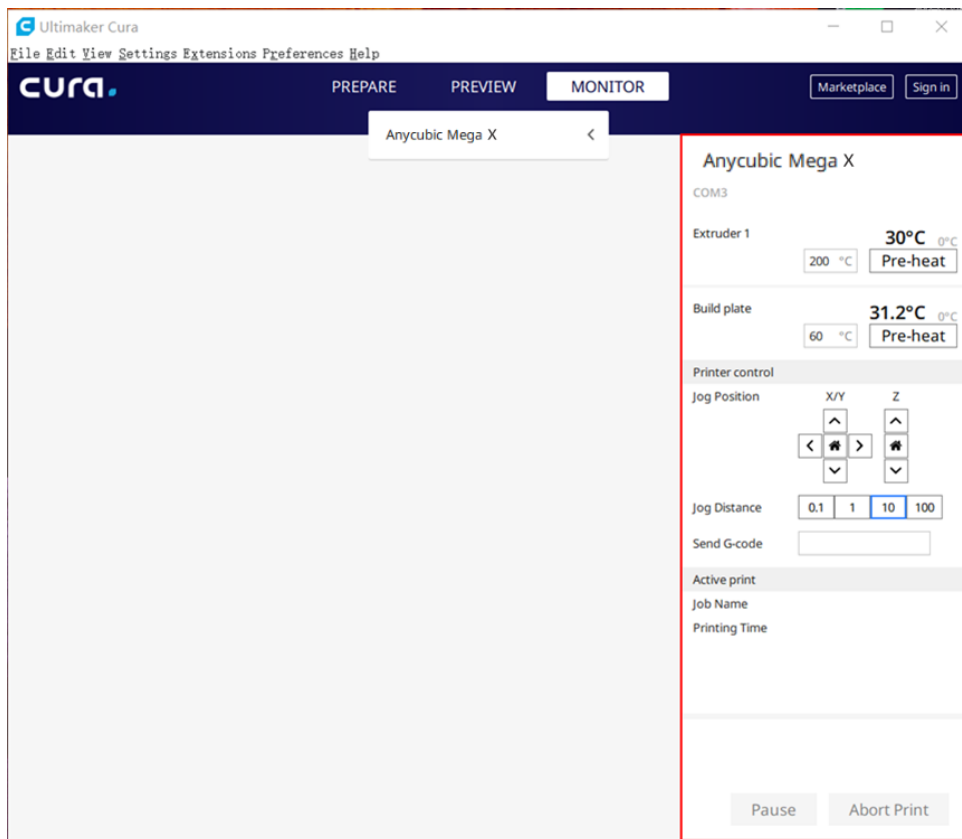

7. Print offline

After slicing, click "save to file" in the lower right corner of Cura software. Save the model GCode file to the **memory card**, and then insert the memory card to the printer and control via the touch screen for offline printing.

Note: the file name should only contain English letters, underscore and space. File name contains special characters could not be recognized by the printer. In order to let the printer better recognize the Gcode file in the memory card, you need to back up all the files in the memory card to the computer, and keep the memory card only for the Gcode file, please save all the Gcode files in root directory of the memory card.

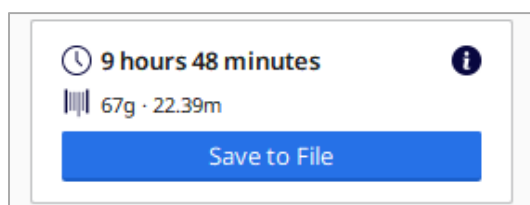

Printing

Here shows the steps of printing offline (via memory card).

1. Plug in the power cord and power on the printer.

Click "Tools" → "Preheat" → "Preheat PLA" (for example).



2. After the pre-heat is finished, please click on Home screen

"Tools"→"Filament" →"Filament in". The extruder motor will start to feed the filament into the hotend. There might be some excessive filament melt through the nozzle at high temperature, use tweezers to carefully remove it from the nozzle tip before print.

3. Insert the memory card into the memory card slot at the base. On Home Menu, Click "Print" to enter the files list. Click a exist file (e.g. "owl_pair"), and click "Print". The machine will be sequentially heating the heated bed and nozzle and then print.



Printing

4. Upon finishing, the print head and heated bed will be automatically cooling down. Only remove the printed object from the heated bed when it is cooled completely. Pull the print platform to the front side, and use spatula to carefully remove the object. Never direct scarper to your hands.

Please be mindful that the nozzle and heated bed are still hot after operation.



5. Mega X 3D printer equipped with **ANYCUBIC** ultrabase(a novel print platform) which could be used for very long time without adding any masking tape, “hair spray” or glue stick. Customers only have to clean it by alcohol or similar after every few prints.

Suggested nozzle (print) temperature for PLA: 190-210 °C, ABS: 230-240 °C, Bed temperature for PLA: 60 °C, ABS: 90 °C. (it is suggested to disable the model cooling fan for ABS in Advanced settings of Cura)

After operation, do not immediately switch off the printer. Only turn it off after the nozzle cools to room temperature, because the heat sink still needs fan for cooling to minimize the risk of nozzle clogging.

Introduction to filament sensor

1. Mega X alarms when filament break during an ongoing print, the interface shown below will be popped up.

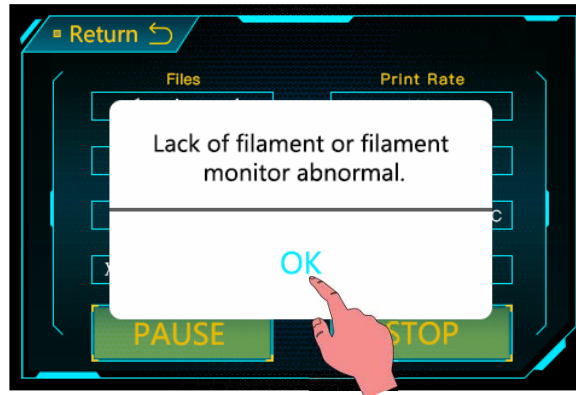

2. Click "OK", remove the remaining filaments and re-installing new filaments. **Remove the remaining filaments:** pull out the teflon feeding tube, then press the handle on the extruder and firstly push the filament in till the filament is just melted through the nozzle, then pull it out quickly.

Re-install new filaments: see page 19 "Filament in".

3. After the filaments re-installed, use tweezers to clean the filament residue on nozzle tip. Then click "CONTINUE", the print will start again from the last position.

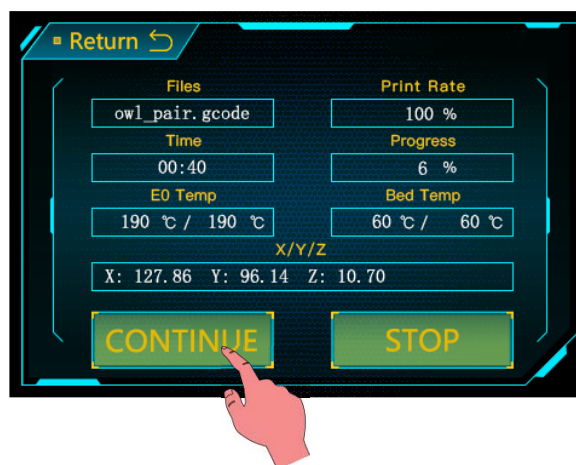

Resume from outage

Mega X allows resume print after accidentally power outage (This function only valid when print offline, via memory card only).

1. As shown in Fig.(1)(2) , in slicing software (i.e. Cura), it is required to place the model at the rear of the platform. Because during “RESUME”, machine will home first and could touch/interfere with the unfinished object if the model was placed in the front area.

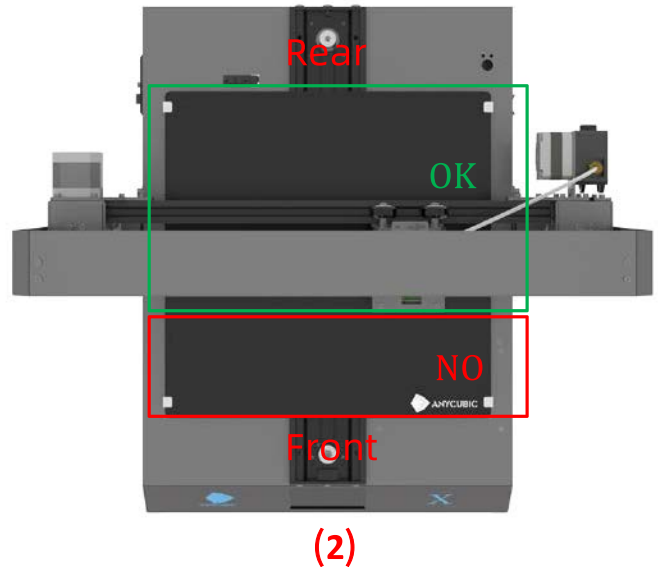
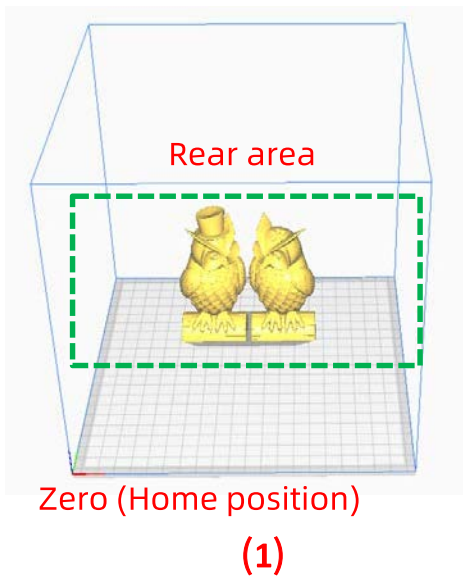

2. For the first time of using this function, users are required to add “G5” to the start.gcode, as shown in Fig. (3). Then, save the model as GCode file to the memory card.

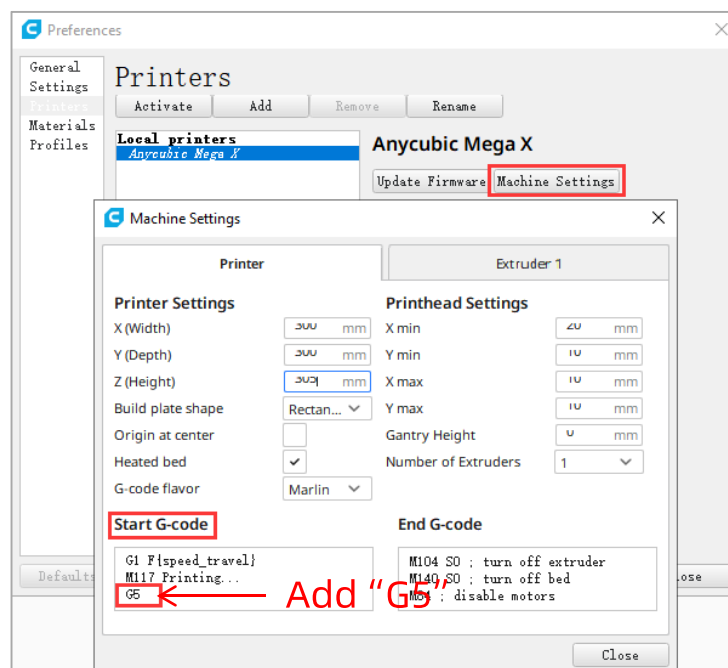

Resume from outage

Note: ① “Resume from outage” is valid only for offline printing;

② Just type the “G5” when you use it for the first time, G5 will be automatically added later, without having to manually type it again.

3. During printing, if there is an accident power loss, the print will stop immediately. But after power comes back, customers could choose “Print” → select the unfinished file → “RESUME”, machine will home first and continuing on the unfinished object.

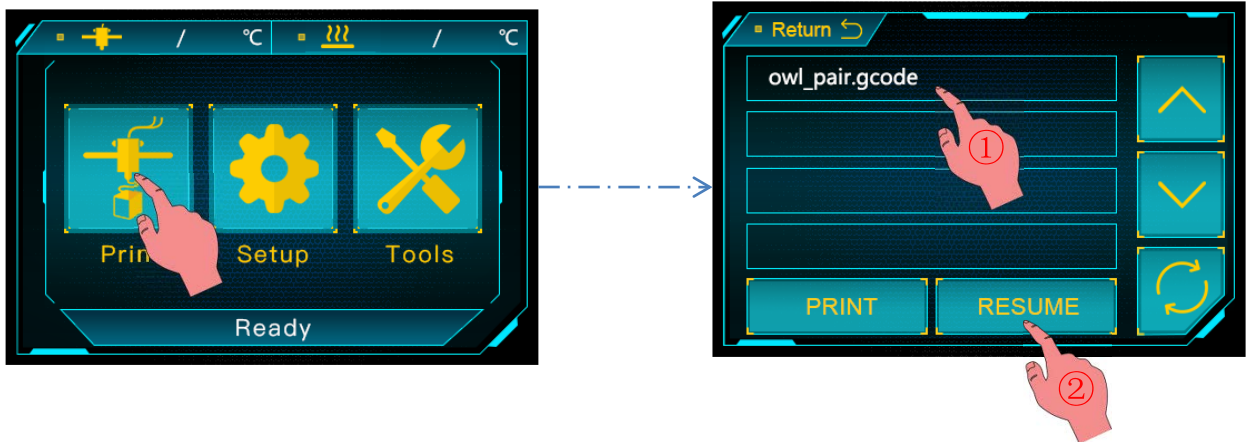

Note:

- ① In order to get smooth surface, use tweezers to carefully remove the excessive filament at nozzle before continuing print upon the last point.
- ② Do not move Z axis after power off otherwise resume will be invalid.
- ③ Mega X supports resume from outage only when print offline
- ④ This function is developed based on Cura. We could not guarantee this function compatible with other slicing software.
- ⑤ Due to the differences of models, filaments, temperature, extrusion settings, etc...we could not always guarantee a perfect surface finish at the point of “RESUME”, especially for small objects.

Maintenance

It is necessary to perform routine maintenance to the 3D printer to achieve consistent and quality results.

Some maintenance suggestions are shown as below:

1. Clean the nozzle with the nozzle cleaning needle under preheating conditions. If the filament residual in the nozzle could not be cleared 100%, please replace the nozzle.
2. Regularly add lubricating oil to smooth rods, flanged bearings, lead screws, brass nuts, etc. By doing so, it can minimize the wear-out failure of those moving parts.
3. Regularly clean the filament residuals and dirt on the nozzle, platform, guide rail, motor, fan, etc.
4. Pay attention to the wear conditions of the D-shape wheels. They could be used for long time, but please replace the D-shape wheels if they have been wore-out. Besides, you need to adjust the tightness of the D-shape wheels by referring to page 9 when they are idling.
5. After finishing a print, clean the heated bed to ensure the adhesion of the bottom layer of the model for next print.
6. Check the belts regularly and tighten them if necessary.

Troubleshooting

1. Motor shaking or abnormal sound

- ① The corresponding end stop could not be triggered when Home, check the wirings, and inspect any obstacles by manually moving the corresponding axis.
- ② The motor cable are not connected properly, check each connection and then inspect the cable routing for any faults.
- ③ The motor is damaged.

2. File not printing or memory card failure

- ① Remove the memory card and insert into PC. Open the GCode files using text editor (eg. Notepad), and inspect if GCode is readable or not. If files contains of multiple “ÿÿÿ” symbol, then file has been corrupted. Try reformatting the memory card to FAT32 format and reloading the GCode file
- ② Memory card is not readable, ensure file name does not contain special characters or Change memory card
- ③ Touch screen freeze, reboot the machine and try again

3. The temperature of the nozzle gradually drops after clicking print

- ① The printing process is a process of executing the print file one by one command. The command to start printing is usually to heat the heated bed, heat the nozzle, home, etc.. It need to wait for the heated bed command to execute before executing the heated nozzle command.

4. No extrusion or extrusion motor knocking

- ① Ensure that the nozzle temperature has been set to match the filament
- ② Filament tangled on spool
- ③ Not enough cooling for the hotend

Troubleshooting

- ④ Nozzle clogged please try to replace it or clean it with the nozzle cleaning needles
- ⑤ Teflon tubing has been tangled, squeezed or bent

5. Filament leaking

Nozzle or throat tube is not tightened properly, try to fix/change it after cooling

6. Warping/curling of the printed object

- ① Check the bed temperature matches the filament
- ② Check the infill % of the GCode. The higher the infill, the more likely to warp
- ③ Add a brim or raft to the model in slicing software.

7. Layer shifting

- ① Print head moving too fast, slow down the print speed.
- ② Check X/Y belt and the driving wheel and ensure they are properly installed.
- ③ Grease the rods and check all nuts and bolts remain tightened.

8. No sticking to the bed

- ① Print too fast at the bottom layer speed, reduce it to ~20mm/s
- ② Ensure that the print platform is clean (use alcohol if necessary)
- ③ Check if the bed is proper leveled
- ④ Add a brim or raft to the model in slicing software
- ⑤ Check the bed temperature matches the filament

9. Freezing screen

- ① Inspect if the touch screen has been pressed by the metal frame at the edge
- ② Check if screen has cracks, if so, please contact us at

www.anycubic.com

Troubleshooting

10. T0 sensor abnormal

- ① Check the wiring of the hotend and ensure a good connection
- ② Check if there is any pins bent inside the connector

11. Print head move abnormal

- ① Check if choosing the right machine type in slicing software
- ② Check if any plugins in the slicing software

12. Print stopped halfway

- ① Check if the GCode file is corrupted.
- ② Delete plugins in the GCode file.
- ③ Use print offline mode (memory card) instead of print online via data cable.

13. The print model is too large to be removed from the platform

- ① Preheat the platform and then shovel it with a spatula.

14. The model looks normal but some parts cannot be printed

- ① Special parts such as overhanging part need to be added with support, etc., and need to be adjusted according to the specific model. It is recommended to preview the print layer to see if it meets the requirements.

15. Drawing is more serious

- ① The retraction distance is insufficient. It should be set larger when slicing.
- ② The retraction speed is too slow. It should be set a bit faster when slicing.
- ③ The printing temperature is too high, which causes the fluidity and viscosity of the filament to be strong. The printing temperature need to be set lowered a little.

Thank you for purchasing **ANYCUBIC** products! Under normal usage and service, the products and its parts have a warranty period up to one year. Please visit **ANYCUBIC** official website (www.anycubic.com) for more details and report any issues with **ANYCUBIC** products. Our professional after-sale service team would response within 24 hours and help you to solve the issue.



MOT025