



Paulmann

Safety Instructions

1, 2, 3, 4, 7, 8, 11, 12, 13, 14, 16, 17, 18, 19, 20, 33, 34;



Info

www.paulmann.com

Paulmann Licht GmbH
Quezinger Feld 2
31832 Springe
Germany

www.paulmann.com

Art.-Nr.: 999.52
999.53



999.52/53

(+MA 326)PEO 04/20

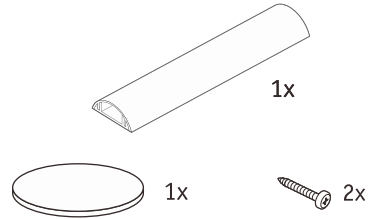
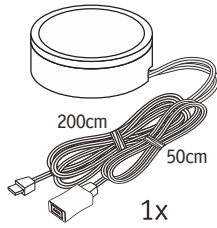

A

Not incl 999.52 / 53

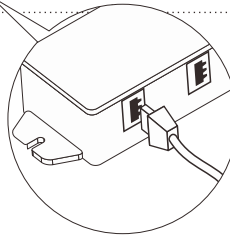
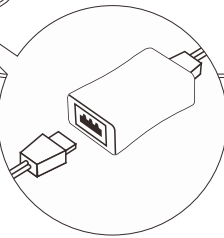
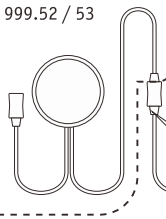

999.46
999.47
999.48

Not incl

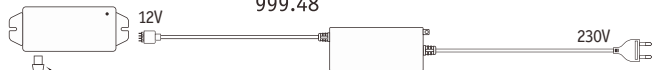

B1

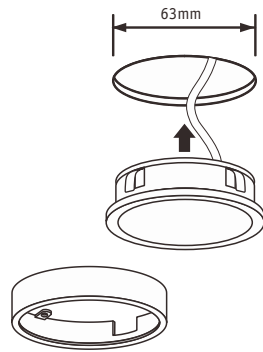
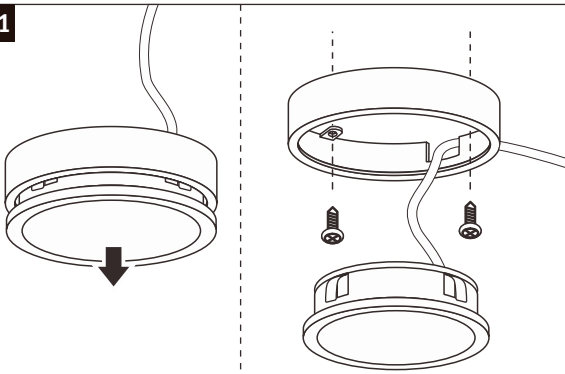

B2

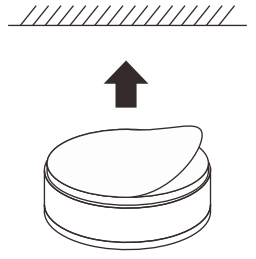
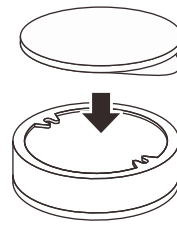

C

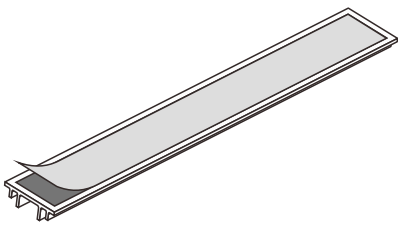

D

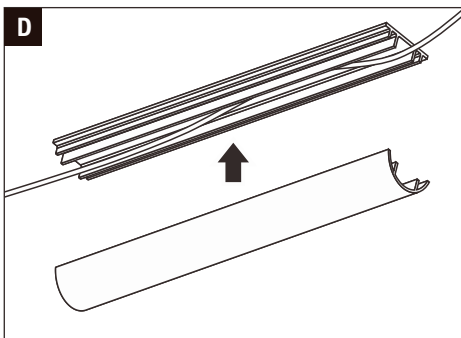

E

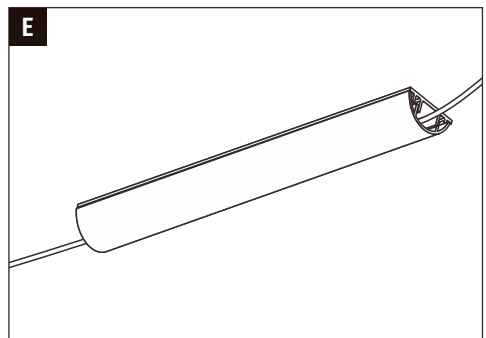

Not incl.

Driver: Max.12W

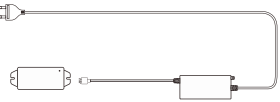

Paulmann
Art.Nr:999.46

Not incl.

Driver: Max.25W

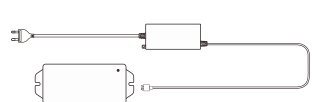

Paulmann
Art.Nr:999.47

Not incl.

Driver: Max.36W

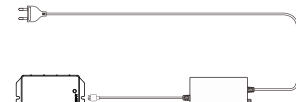

Paulmann
Art.Nr:999.48

Not incl.

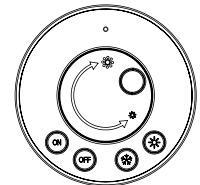

Paulmann
Art.Nr:999.76

Function of keys

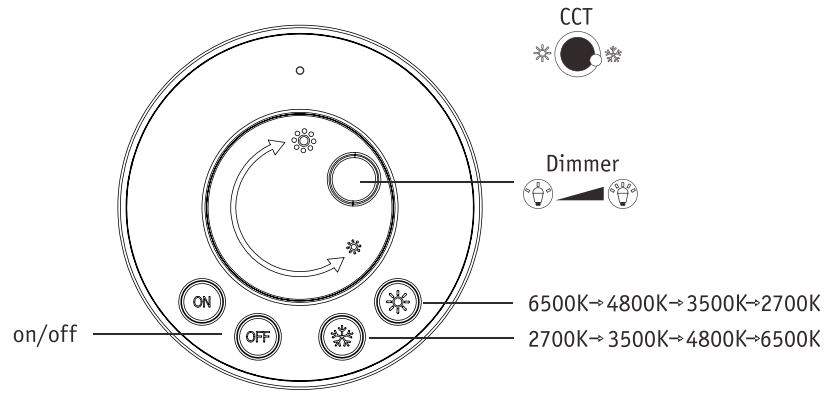

Code Matching

(Press the "ON" button one time within 5s of connecting to the controller)

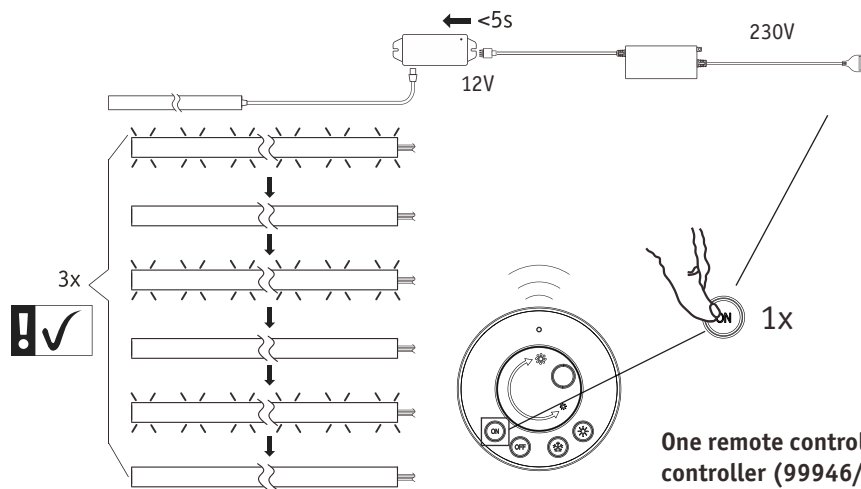

One remote control can control countless controller (99946/99947/99948), but a controller (99946/99947/99948) can be only controlled by 4 pcs remote control.

Code Clearing

(Press the "NO" button three times within 5s of cancelling the connection to the controller)

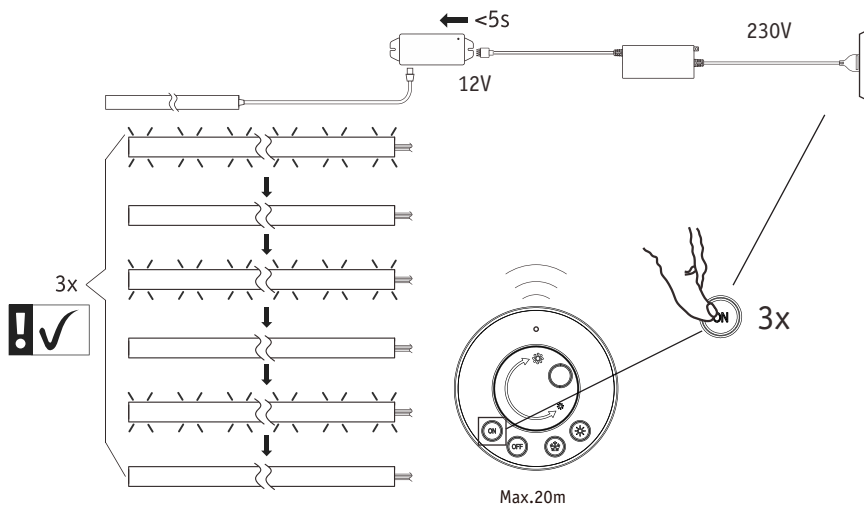

Hiermit erklärt Paulmann Licht, dass der Funkanlagentyp Art.-Nr.: 999.52/999.53 der Richtlinie 2014/53/EU entspricht. Der vollständige

Text der EU-Konformitätserklärung ist unter der folgenden Internetadresse verfügbar: www.paulmann.de

Zugelassen für den Betrieb in allen Ländern der EU / Approved for operating in all European countries

CE: Konform mit / in accordance with / conformément a 2014/30/EU, 2014/53/EU <http://www.paulmann.com/ce>

Funk-Frequenz :2.4GHz -2.4835GHz Abgestrahlte Energie :10mW  NO

Doesn't apply for the geographical area within a radius of 20km from the centre on "Ny Alesund"