

# Data Sheet

## Micro Switch, Tappet, 250VAC 16A

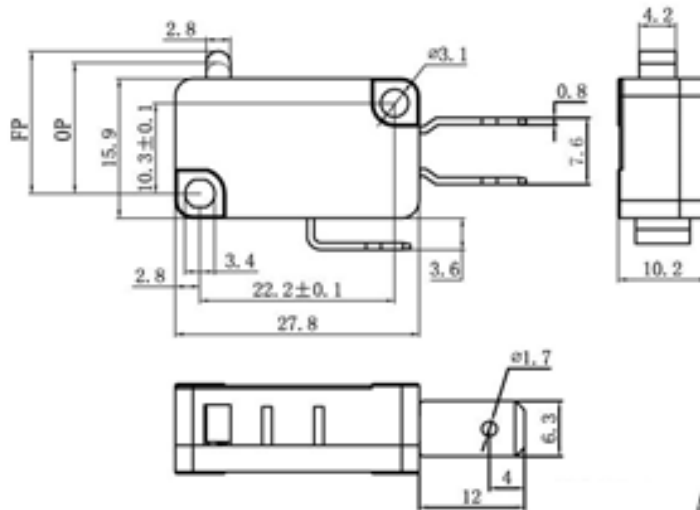

### Action characteristic

项目	参数
FP	16.4 MAX (mm)
OP	14.9 ± 0.5 (mm)
OF	100 MAX (gf)

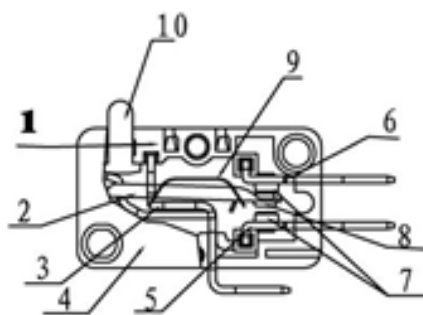

Sketch map

10	按钮 BUTTON	1	PPY	红色 RED
9	簧片 SPRING	1	铍青铜 BERYLTIUM BRONZE	
8	动电触点 ELECTRICAL CONTACTS	1	Ag	
7	静电触点 THE STATIC CONTACT	2	AgCd0.12/Cu	
6	常闭端子 NC TERMINAL	1	黄铜 BRASS	镀银 SILVERING
5	常开端子 NO TERMINAL	1	黄铜 BRASS	镀银 SILVERING
4	盖子 COVER	1	PPY	黑色 BLACK
3	支架 SUPPORT	1	黄铜 BRASS	镀银 SILVERING
2	可动片 MOVING PIECE	1	磷铜 PHOSPHOR COPPER	镀银 SILVERING
1	基板 SUBSTRATE	1	PPY	黑色 BLACK
序号 NO.	名称 NAME	数量 QUANTITY	材料 MATERIAL	备注 REMARK

# Data Sheet

## ■型号标准 Model standard

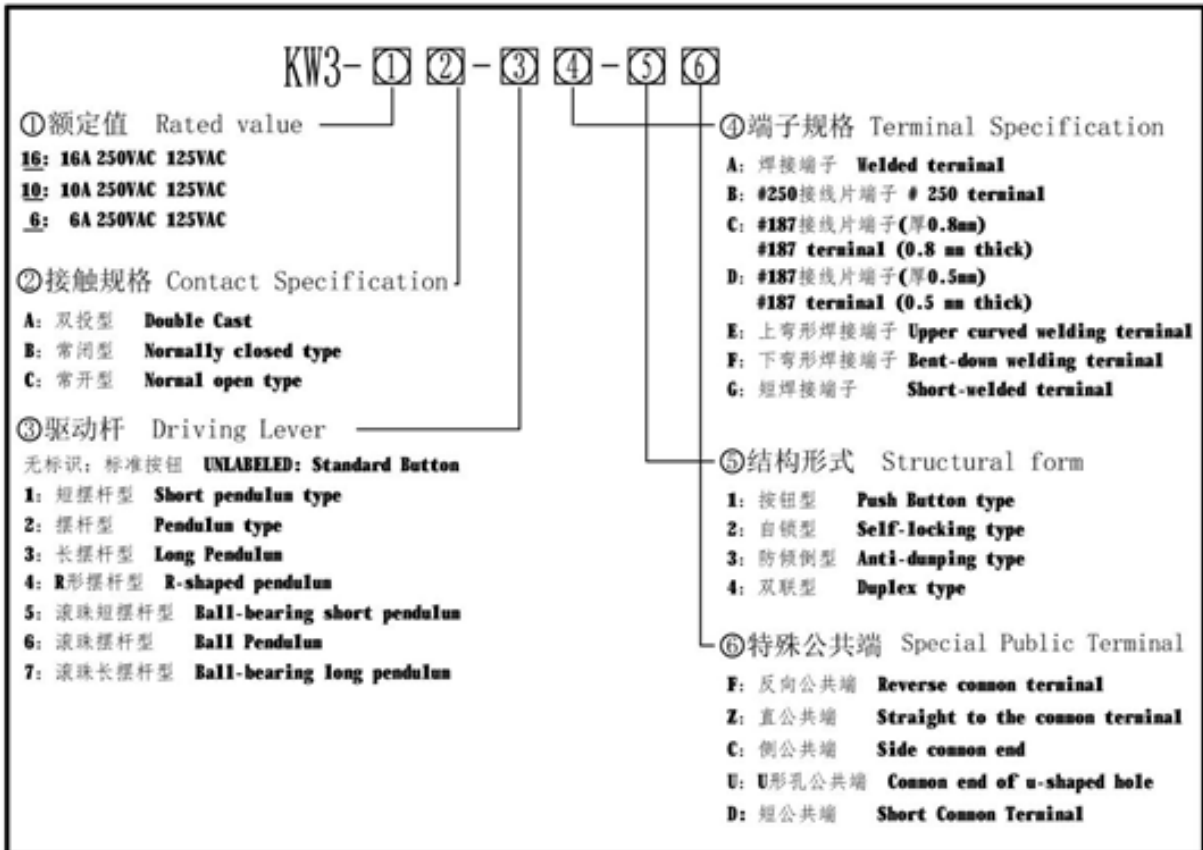

## ■技术特性 Technical characteristics

项目 Item		特性值 Value
工作速度 Operating Speed		0.1mm-1m/s(与驱动方式有关) Related with actuator forms
操作频率 Operating Frequency	电器 Electrical	15次/分 cycles/minute
	机械 Mechanical	60次/分 cycles/minute
温度等级 Degree of temperature		T105
额定电压 Rated voltage		AC250V
绝缘电阻 Insulation resistance		≥100MΩ (500VDC)
接触电阻 Contact resistance		≤30mΩ (初始值) (Initial value)
耐电压 Test voltage	同极不相接端子间 Between terminals of the same polarity	AC1000V, 50/60Hz, 1min
	带电金属零件与地(外壳)之间, 接线端与不带电金属之间 Between current-carrying metal parts and ground(case), and between each terminal and non-current-carrying metal parts.	AC1500V, 50/60Hz, 1min
寿命 Life		机械≥1,000,000 次; Mechanical ≥1,000,000 cycles 电气≥50,000 次; Electrical ≥50,000 cycles

# Data Sheet

■ 开关动作特性解图 Diagram of switching action characteristics

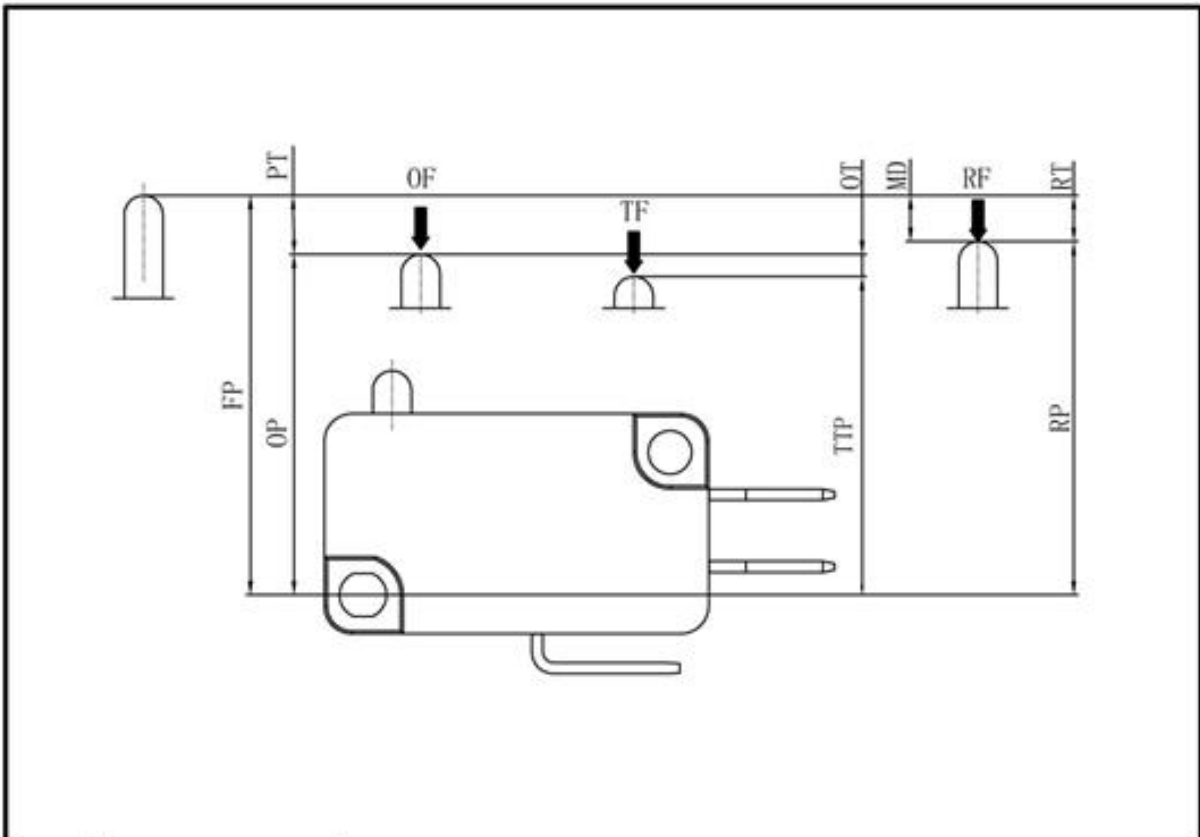

代号 Code	参数名称 Name	含义 Meanings
PT	动作行程 Pre travel	驱动件从自由位置到动作位置间的位移 The displacements of actuator from free positioning to operating position.
OT	超行程 Over travel	驱动件从动作位置到全行程位置间的位移 The displacements of actuator from operating positioning to total travel position.
MD	差动行程 Movement differential travel	驱动件从动作位置到释放位置或释放位置到动作位置间的位移 The displacements of actuator from operating positioning to release position.
RT	释放行程 Release travel	驱动件从释放位置到自由位置间的位移 The displacements of actuator from release positioning to free position.
OF	动作力 Operating force	驱动件从自由位置到动作位置必须的最大推力。 The max. force of displacements of actuator from free positioning to operating position.
TF	全行程力 Total travel force	驱动件在全行程位置所承受的最小操作力 The smallest force of displacements of actuator on total travel position .
RF	释放力 Release force	驱动件自正向动作位置返回到释放位置，操作减小到最小值 The force when the actuator moved back to release position from obverse operating position.
TTP	全行程位置 Total travel position	驱动件被止动时所处的位置 The position where the actuator be stoppde .
OP	动作位置 Operating position	驱动件在瞬动机构发生正向动作瞬间所处的位置 The position where the actuator moved obverse on quick-moving parts.
RP	释放位置 Release position	驱动件在瞬动机构发生反向动作瞬间所处的位置 The position where the actuator moved reversely on quick-moving parts.
FP	自由位置 Free position	驱动件在不承受操作力以及力不足以引起位移时所处的位置 The position where the actuator lead the displacements when its out of force is not enough.

# Data Sheet

## ■安装孔加工尺寸 Machining dimension of mounting

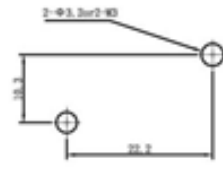
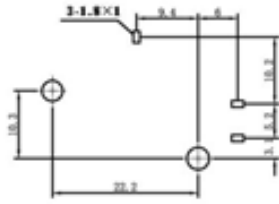
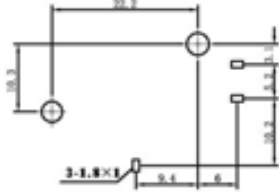
	右侧面PCB端子 Right side PCB terminal	左侧面PCB端子 Left side PCB terminal
		

## ■接触形式说明图 Contact form diagram

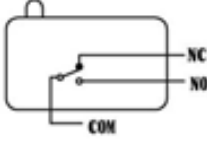
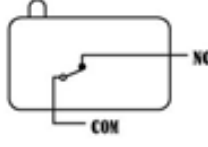
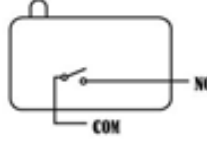
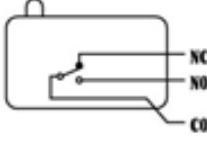
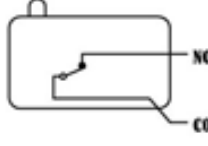
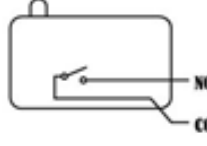
公共端类型 Common terminal types	转换式 SPDT (双投型)	常闭式 SPST-NC	常开式 SPST-NO
公共端在底部 Bottom common terminal			
公共端在侧面 Side common terminal			

## ■端子的种类/形状 Type/shape of terminal

焊接端子 Welded terminal	#187接线片端子 Terminal block #187	#250接线片端子 Terminal block #250
