



**KERN & Sohn GmbH**

Ziegelei 1  
D-72336 Balingen  
email: [info@kern-sohn.com](mailto:info@kern-sohn.com)

Phone: +49-[0]7433- 9933-0  
Fax: +49-[0]7433-9933-149  
Internet: [www.kern-sohn.com](http://www.kern-sohn.com)

# Operating Manual Counting balances

## KERN CKE/CDS

Version 2.7  
04/2016  
GB



CKE-BA-e-1627



# KERN CKE/CDS

Version 2.7 04/2016

## Operating Manual Counting balances

### Table of Contents

<b>1</b>	<b>MODE – MENU</b> .....	<b>3</b>
<b>2</b>	<b>Technical Data</b> .....	<b>4</b>
2.1	KERN CKE .....	4
2.2	KERN CDS .....	7
<b>3</b>	<b>Basic Information (General)</b> .....	<b>9</b>
3.1	Proper use.....	9
3.2	Improper Use .....	9
3.3	Warranty.....	9
3.4	Monitoring of Test Resources .....	9
<b>4</b>	<b>Basic Safety Precautions</b> .....	<b>10</b>
4.1	Pay attention to the instructions in the Operation Manual.....	10
4.2	Personnel training .....	10
<b>5</b>	<b>Transport and storage</b> .....	<b>10</b>
5.1	Testing upon acceptance .....	10
5.2	Packaging / return transport.....	10
<b>6</b>	<b>Unpacking, Setup and Commissioning</b> .....	<b>11</b>
6.1	Installation Site, Location of Use .....	11
6.2	Unpacking .....	11
6.2.1	Placing .....	11
6.3	Mains connection .....	11
6.4	Battery operation CKE.....	12
6.5	Connection of peripheral devices.....	12
6.6	Initial Commissioning .....	12
6.7	Adjustment .....	13
6.8	Adjusting (see chapter 7.2.1) .....	13
6.9	Verification .....	13
<b>7</b>	<b>Operation</b> .....	<b>14</b>
7.1	Control panel CKE/CDS .....	14
7.2	Operation .....	15
7.2.1	Adjusting .....	15
7.2.2	Speed .....	15
7.2.3	Auto Off.....	15
7.2.4	Display background illumination.....	17
7.2.5	Swap: .....	17
7.2.6	Contents of the form printout: .....	17
7.3	Data output RS 232 C .....	18
7.4	Interface RS 232C.....	19
7.4.1	There are 4 kinds of data output via RS 232C .....	19
7.4.2	Explanation of the data transfer .....	19
7.4.3	Numerator .....	19
7.5	Printer.....	20
7.6	Underfloor weighing .....	20
<b>8</b>	<b>Service, maintenance, disposal</b> .....	<b>21</b>
8.1	Cleaning .....	21
8.2	Service, maintenance.....	21
8.3	Disposal .....	21
<b>9</b>	<b>Instant help</b> .....	<b>21</b>
<b>10</b>	<b>Declaration of conformity</b> .....	<b>22</b>

# 1 MODE – MENU

How to invoke the mode menu: Turn on balance, press and hold the tare key and press the ON/OFF key.  
Let go of the tare key.

## CKE / CDS

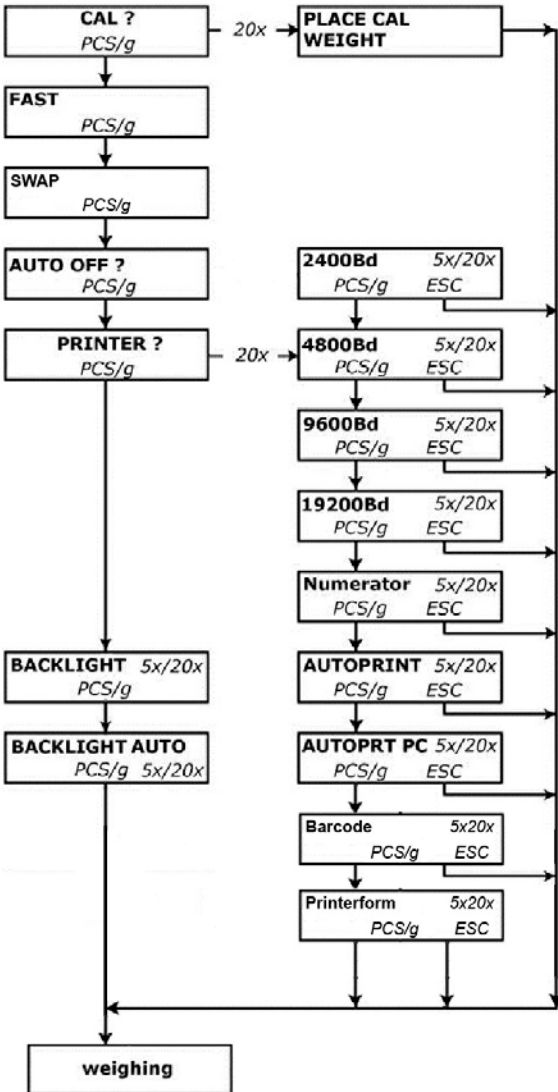

## Factory settings:

9600bd: YES

Fast: 3

## Keyboard overview / Function

No	Yes
	

Using the automatic reference optimization (OPT) the counting accuracy is automatically increased when applying up to 100 items.

## 2 Technical Data

### 2.1 KERN CKE

KERN	CKE 360-3	CKE 2000-2	CKE 3600-2	CKE 6K0.02
Readability (d)	0,001 g	0,01 g	0,01 g	0,02 g
Weighing range (max)	360 g	2.000 g	3.600 g	6.000 g
Taring range (subtractive)	360 g	2.000 g	3.600 g	6.000 g
Reproducibility	0,002 g	0,01 g	0,02 g	0,04 g
Linearity	±0,005 g	±0,03 g	±0,05 g	±0,1 g
Smallest piece weight	0,001 g	0,01 g	0,01 g	0,02 g
Adjustment point	100/200/300/ 360 g	0,5/1,0/1,5/2,0 kg	1,0/2,0/3,0/3,6 kg	2/4/5/6 kg
Recommended adjustment weight (F1), not added	300 g	2 kg	2 kg + 1 kg	5 kg
Appropriate for verification	max. 80% rel. (non-condensing)			
Stabilization time (typical)	3 sec.			
Allowable ambient temperature	+10 °C ... + 40 °C			
Warm-up time	2 hours	2 hours	4 hours	4 hours
Housing (B x D x H) mm	167 x 250 x 85	167 x 250 x 85	167 x 250 x 85	350 x 390 x 120
Vibration filter	yes			
Weighing plate, stainless steel	Ø 81	150 x 170	150 x 170	340 x 240
Units	see menu			
Weight kg (net)	1,1	1,7	1,7	6,5
Data interface	yes (RS232)			
Rechargeable battery pack with 7,2 V/2000mAh	yes			no
Battery operation with 6 x 1.5 V; Size C	no			yes

<b>KERN</b>	<b>CKE 8K0.05</b>	<b>CKE 16K0.05</b>	<b>CKE 16K0.1</b>
Readability (d)	0,05 g	0,05 g	0,1 g
Weighing range (max)	8.000 g	16.000 g	16.000 g
Taring range (subtractive)	8.000 g	16.000 g	16.000 g
Reproducibility	0,05 g	0,1 g	0,1g
Linearity	±0,15 g	±0,25 g	± 0,3 g
Smallest piece weight	0,05 g	0,05 g	0,1 g
Adjustment point	2/4/5/7/8 kg	5/10/15/16 kg	5/10/15/16 kg
Recommended adjustment weight (F1), not added	5 kg + 2 kg	10 kg + 5 kg	10 kg + 5 kg
Appropriate for verification	max. 80% rel. (non-condensing)		
Stabilization time (typical)	3 sec.		
Allowable ambient temperature	+10 °C ... + 40 °C		
Warm-up time	2 hours	4 hours	2 hours
Housing (B x D x H) mm	350 x 390 x 120		
Vibration filter	yes		
Weighing plate, stainless steel	340 x 240		
Units	see menu		
Data interface	6,5		
Data interface	yes (RS232)		
Battery operation with 6 x 1.5 V; Size C	yes		

<b>KERN</b>	<b>CKE 36k0.1</b>	<b>CKE 65k0.2</b>	<b>CKE 65k0.5</b>
Readability (d)	0,1 g	0,2 g	0,5 g
Weighing range (max)	36.000 g	65.000	65.000
Taring range (subtractive)	36.000 g	65.000	65.000
Reproducibility	0,2 g	0,4 g	0,5 g
Linearity	±0,5 g	±1,0 g	± 1,5 g
Smallest piece weight	0,1 g	0,2 g	0,5 g
Adjustment point	10/20/30/36 kg	20/30/50/60 kg	20/30/50/60 kg
Recommended adjustment weight (F1), not added	20 kg + 10 kg	50 kg	50 kg
Appropriate for verification	max. 80% rel. (non-condensing)		
Stabilization time (typical)	3 sec.		
Allowable ambient temperature	+10 °C ... + 40 °C		
Warm-up time	2 hours	4 hours	2 hours
Housing (B x D x H) mm	350 x 390 x 120		
Vibration filter	yes		
Weighing plate, stainless steel	340 x 240 mm		
Units	see menu		
Weight kg (net)	6,5		
Data interface	yes (RS232)		
Battery operation with 6 x 1.5 V; Size C	yes		

## 2.2 KERN CDS

KERN	CDS 4K0.02	CDS 15K0.05	CDS 16K0.1	CDS 30K0.1	CDS 30K0.1L
Readability (d)	0,02 g	0,05 g	0,1 g	0,1 g	0,1 g
Weighing range (max)	4.000 g	15.000 g	16.000 g	30.000 g	30.000 g
Taring range (subtractive)	4.000 g	15.000 g	16.000 g	30.000 g	30.000 g
Reproducibility	0,02 g	0,2 g	0,1 g	0,2 g	0,2g
Linearity ±	±0,06 g	±0,25 g	±0,3 g	±0,5 g	± 0,5 g
Smallest piece weight	0,02 g	0,05 g	0,1 g	0,1 g	0,1 g
Adjustment point kg	1/2/4	2/5/10/15	2/5/10/15/16	10/15/20/30	10/15/20/30
Recommended adjustment weight (F1), not added	2 kg + 2 kg	10 kg + 5 kg	10 kg + 5 kg	20 kg + 10 kg	20 kg + 10 kg
Appropriate for verification	max. 80% rel. (non-condensing)				
Stabilization time (typical)	3 sec.				
Allowable ambient temperature	+10 °C ... + 40 °C				
Warm-up time	2 hours	4 hours	4 hours	2 hours	4 hours
Housing (B x D x H) mm	315 x 305 x 70			450 x 350 x 115	
Vibration filter	yes				
Weighing plate, stainless steel	315 x 305 mm			450 x 350 mm	
Units	see menu				
Weight kg (net)	7,5			9,5	
Data interface	yes (RS232)				
Rechargeable battery pack with 7,2 V/2000mAh	yes				

<b>KERN</b>	<b>CDS 36K0.2L</b>	<b>CDS 60K0.2</b>	<b>CDS 100K0.5</b>
Readability (d)	0,2 g	0,2 g	0,5 g
Weighing range (max)	36.000 g	60.000 g	100.000 g
Taring range (subtractive)	36.000 g	60.000 g	100.000 g
Reproducibility	0,2 g	0,4 g	0,5 g
Linearity ±	±0,6 g	±1,0 g	±1,5 g
Smallest piece weight	0,2 g		
Adjustment point kg	10/15/20/30/36	20/30/50/60	20/50/100
Recommended adjustment weight (F1), not added	20 kg + 10 kg	50 kg	50 kg + 50 kg
Appropriate for verification	max. 80% rel. (non-condensing)		
Stabilization time (typical)	3 sec.		
Allowable ambient temperature	+10 °C ... + 40 °C		
Warm-up time	2 hours	2 hours	2 hours
Housing (B x D x H) mm	450 x 350 x 115		
Vibration filter	yes		
Weighing plate, stainless steel mm	450 x 350		
Units	see menu		
Weight kg (net)	9,5		
Data interface	yes (RS232)		
Rechargeable battery pack with 7,2 V/2000mAh	yes		



### **3 Basic Information (General)**

It is absolutely necessary that you read and understand the operating instructions prior to installation and commissioning and follow the instructions during the process!

#### **3.1 Proper use**

The balance you purchased is intended to determine the weighing value of material to be weighed. It is intended to be used as a "non-automatic" balance, i.e. the material to be weighed is manually and carefully placed in the centre of the weighing plate. As soon as a stable weighing value is reached the weighing value can be read.

#### **3.2 Improper Use**

Do not use balance for dynamic weighings. In the event that small quantities are removed or added to the material to be weighed, incorrect weighing results can be displayed due to the "stability compensation" in the balance. (Example: Slowly draining fluids from a container on the balance.)

Do not leave permanent load on the weighing plate. This may damage the measuring system.

Impacts and overloading exceeding the stated maximum load (max) of the balance, minus a possibly existing tare load, must be strictly avoided. Balance may be damaged by this.

Never operate balance in explosive environment. The serial version is not explosion protected.

The structure of the balance may not be modified. This may lead to incorrect weighing results, safety-related faults and destruction of the balance.

The balance may only be used according to the described conditions. Other areas of use must be released by KERN in writing.

#### **3.3 Warranty**

Warranty claims shall be voided in case

- Our conditions in the operation manual are ignored
- The appliance is used outside the described uses
- The appliance is modified or opened
- mechanical damage and damage caused by media, liquids
- natural wear and tear
- The appliance is improperly set up or incorrectly electrically connected
- The measuring system is overloaded

#### **3.4 Monitoring of Test Resources**

In the framework of quality assurance the measuring-related properties of the balance and, if applicable, the testing weight, must be checked regularly. The responsible user must define a suitable interval as well as type and scope of this test. Information is available on KERN's home page ([www.kern-sohn.com](http://www.kern-sohn.com)) with regard to the monitoring of balance test substances and the test weights required for this. Our accredited DKD calibration laboratory offers fast and inexpensive adjustment for test weights and weighing balances (reset to national normal weight).

## 4 Basic Safety Precautions

### 4.1 Pay attention to the instructions in the Operation Manual



Carefully read this operation manual before setup and commissioning, even if you are already familiar with KERN balances.

Versions in other languages are non-binding translations.  
The only binding version is the original document in German.

### 4.2 Personnel training

The appliance may only be operated and maintained by trained personnel.

## 5 Transport and storage

### 5.1 Testing upon acceptance

When receiving the appliance, please check packaging immediately, and the appliance itself when unpacking for possible visible damage.

In case of visible damage have the damage verified by the messenger's signature. Do not alter goods or packaging and do not remove any parts of the delivery. Report the damage immediately (within 24 hours) in writing to the parcel service.

### 5.2 Packaging / return transport



- ⇒ Keep all parts of the original packaging for a possibly required return.
- ⇒ Only use original packaging for returning.
- ⇒ Prior to dispatch disconnect all cables and remove loose/mobile parts.
- ⇒ Reattach possibly supplied transport securing devices.
- ⇒ Secure all parts such as the glass wind screen, the weighing platform, power unit etc. against shifting and damage.

## 6 Unpacking, Setup and Commissioning

### 6.1 Installation Site, Location of Use

The balances are designed in a way that reliable weighing results are achieved in common conditions of use. You will work accurately and fast, if you select the right location for your balance.

**Therefore, observe the following for the installation site:**

- Place the balance on a firm, level surface;
- Avoid extreme heat as well as temperature fluctuation caused by installing next to a radiator or in the direct sunlight;
- Protect the balance against direct draughts due to open windows and doors;
- Avoid jarring during weighing;
- Protect the balance against high humidity, vapours and dust;
- Do not expose the device to extreme dampness for longer periods of time. Non-permitted condensation (condensation of air humidity on the appliance) may occur if a cold appliance is taken to a considerably warmer environment. In this case, acclimatize the disconnected appliance for ca. 2 hours at room temperature.
- Avoid static charging of the material to be weighed, weighing container and windshield.

If electro-magnetic fields or static charge occur, or if the power supply is unstable major deviations on the display (incorrect weighing results) are possible. In that case, the location must be changed.

### 6.2 Unpacking

Carefully remove the balance from the packaging, remove plastic cover and setup balance at the intended workstation.

#### 6.2.1 Placing

The balance must be installed in a way that the weighing plate is exactly in horizontal position.

### 6.3 Mains connection

Power is supplied via the external mains adapter. The stated voltage value must be the same as the local voltage.

Only use original KERN mains adapters. Using other makes requires consent by KERN.

## 6.4 Battery operation CKE



- ⇒ To insert the batteries (6 x 1.5 V) remove the battery compartment cover. Remove it with the help of a coin.
- ⇒ In the each battery tube insert three batteries in the same polarity sense.
- ⇒ Screw down again the battery cover.

To save the battery, the background illumination can be switched off (see chap. 1 Mode Menu).

Moreover the AUTO-OFF function can be activated (see chap. 1 Mode Menu).

If the battery voltage drops below a critical value for operational safety, this will be indicated in the display with the "BATT LOW" information.

## 6.5 Connection of peripheral devices

Before connecting or disconnecting of additional devices (printer, PC) to the data interface, always disconnect the balance from the power supply.

With your balance, only use accessories and peripheral devices by KERN, as they are ideally tuned to your balance.

## 6.6 Initial Commissioning

A warming up time of 2 hours after switching on stabilizes the measuring values.

The accuracy of the balance depends on the local acceleration of gravity.

Strictly observe hints in chapter "Adjustment".

## 6.7 Adjustment

As the acceleration value due to gravity is not the same at every location on earth, each balance must be coordinated - in compliance with the underlying physical weighing principle - to the existing acceleration due to gravity at its place of location (only if the balance has not already been adjusted to the location in the factory). This adjustment process must be carried out during the initial start-up, after change in location and variation of surrounding temperature. To receive accurate measuring values it is also recommended to adjust the balance periodically in weighing operation.

## 6.8 Adjusting (see chapter 7.2.1)

With an adjustment weight, the weighing accuracy can be checked and re-adjusted at any time.

**Attention:** In the verified balances the adjustment is not possible.

### **Procedure when adjusting:**

Observe stable environmental conditions. A short warming up time of ca. 15 minutes is recommended for stabilization.

## 6.9 Verification

### General introduction:

According to EU directive 90/384/EEC balances must be officially verified if they are used as follows (legally controlled area):

- a) For commercial transactions if the price of goods is determined by weighing.
- b) For the production of medicines in pharmacies as well as for analyses in the medical and pharmaceutical laboratory.
- c) For official purposes
- d) For manufacturing final packages

In cases of doubt, please contact your local trade in standard.

### Verification instructions





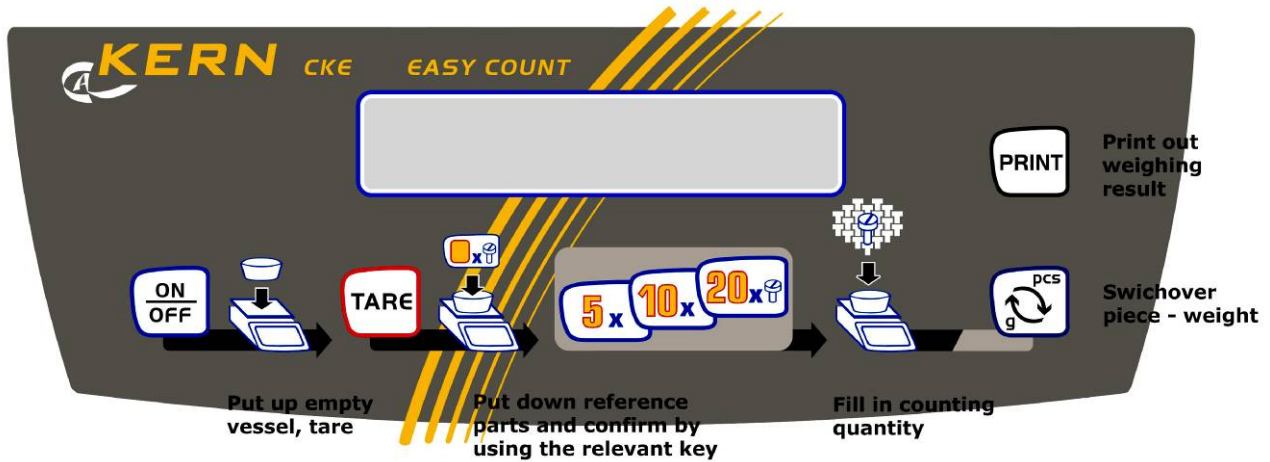

An EU type approval exists for balances described in their technical data as verifiable. If a balance is used where obligation to verify exists as described above, it must officially verified and re-verified in regular intervals. Re-verification of a balance is carried out according to the respective national regulations. The validity for verification of balances in Germany is e.g. 2 years.

The legal regulation of the country where the balance is used must be observed!

## 7 Operation

### 7.1 Control panel CKE/CDS



-  ON/OFF
-  TARE Taring;  
Invoke the mode menu by pressing the ON/OFF key.
-  5x Generate reference using 5 parts;  
In mode menu: NO function
-  10x Generate reference using 10 parts
-  20x Generate reference using 20 parts;  
In mode menu: YES function
-  pcs/g Swichover pcs ↔ g;  
In menu: Mode function.
-  PRINT Print out weighing result.

Display icon	Significance
===OVERLOAD===	Overload: Weighing range exceeded
=====	Underload: Weighing range not achieved
<< .	In add-up and % mode: Part too light
→ .	Balance in add-up mode show the weight value of the counted quantity

## 7.2 Operation

### 7.2.1 Adjusting

KERN CKE  
CDS

The balances must be adjusted at the installation location prior to initial use and at regular intervals.  
Please observe the warming-up time stated in the chapter dealing with initial start-up.  
Do not allow vibrations and disturbances to impair the adjusting process!

### 7.2.2 Speed

KERN CKE  
CDS

The balance can be adjusted from 1-5 to fit in with the installation location.  
Level 1 = excellent installation conditions, fast display / minor filtering (e.g. dosaging)  
Level 5 = bad installation conditions, slow display / high filtering (for unstable environment)  
Example: Dose weighing require a higher display speed; this can be set in the MODE program by selecting FAST.

### 7.2.3 Auto Off

KERN CKE  
CDS

The Auto OFF function turns the balance off after 60 seconds when not used

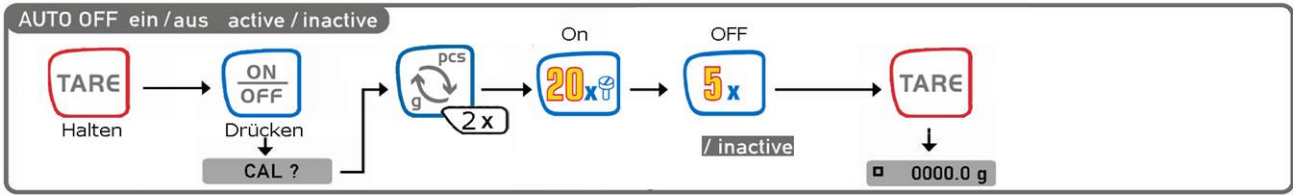
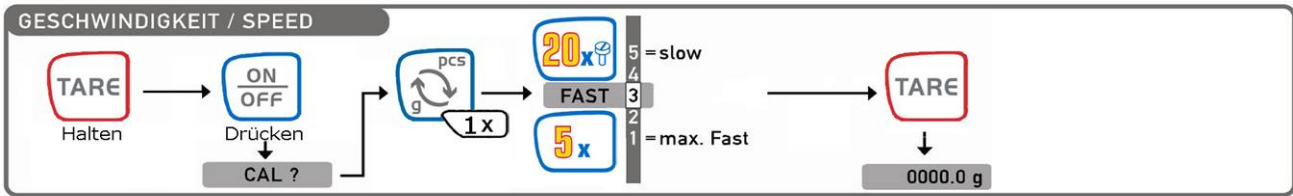
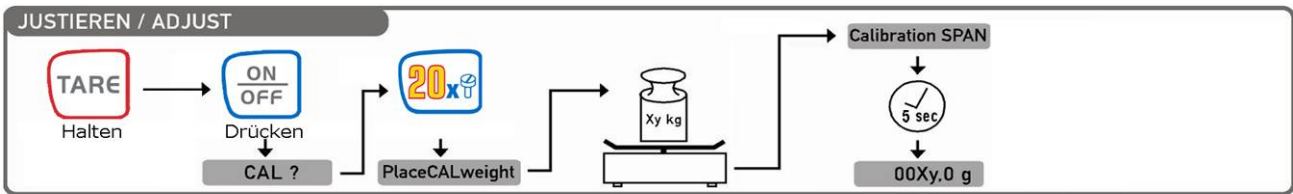



### 7.2.4 Display background illumination

Switch on the balance and the zero display, then call-up the balance menu as specified in chapter 1. Select menu item „Backlight“ using the button necessary for the respective model. Acknowledge by pressing the „YES“ button in order to switch on the background illumination permanently. By pressing the „NO“ button, the background illumination is switched off.

If the background illumination shall be switched off time-controlled (to save the battery), press the respective button for continuing the menu to select the menu point „Backlight auto“ and confirm by pressing the „YES“ button. The background illumination will be switched off automatically 10 sec after having reached a stable weighing value.

### 7.2.5 Swap:

- Strong filtering - Setting under point 1 (Mode-Menu)

### 7.2.6 Contents of the form printout:

#### MODE / PRINTER / PRINTERFORM

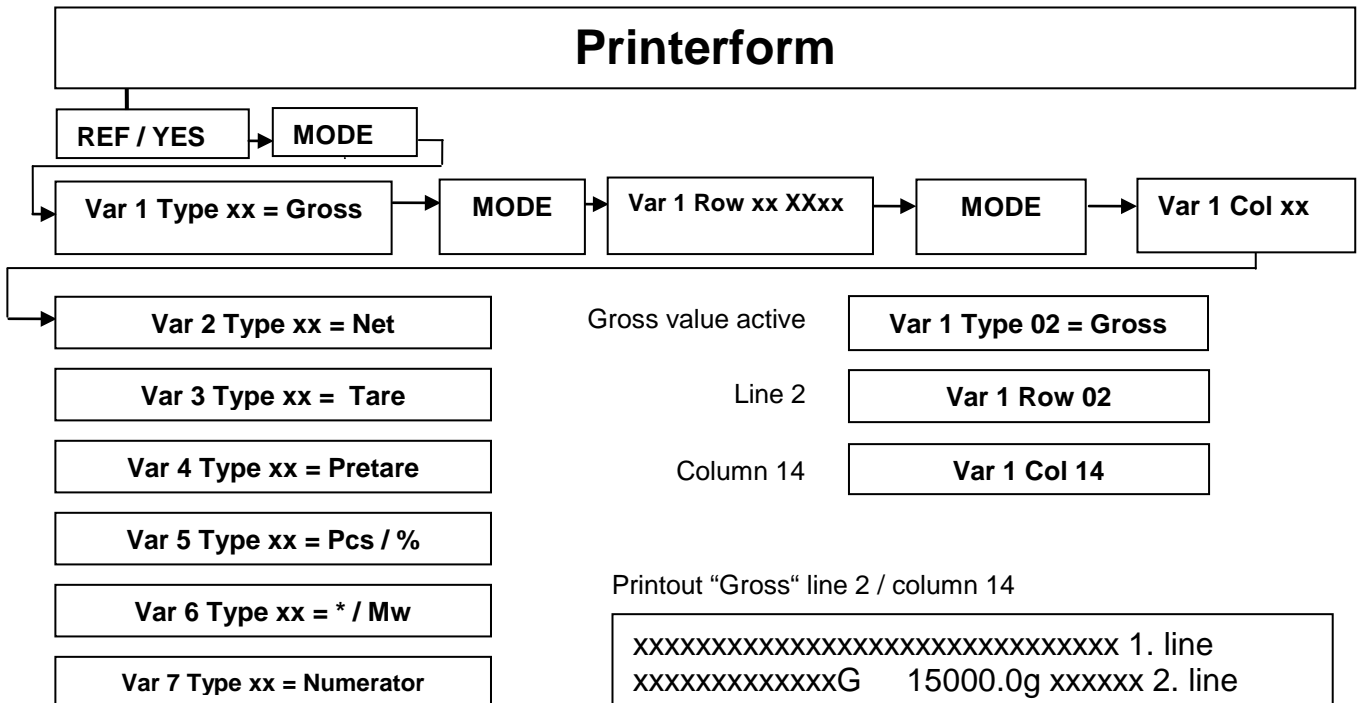

## 7.3 Data output RS 232 C

### Technical Data

#### 8-bit ASCII Code

- 1 start bit, 8 data bits, 1 stop bit, no parity bit
- Baud rate selectable from 2400, 4800, 9600 Baud (factory setting) and 19200 Baud.
- Sub-D plug 9-channel required
- For operation with interface faultless operation is only ensured with the correct KERN – interface cable (max. 2m)

### Pin allocation of the balance output socket (front view)

Sub-D jack 9-channel

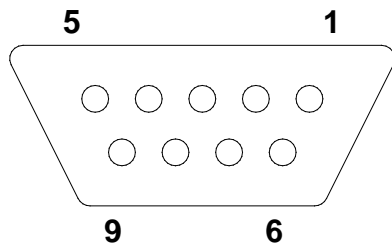

Pin 2: Transmit data

Pin 3: Receive data

Pin 5: Signal ground

### Baud rate

The MODE key is used to set the Baud rate used for the transfer of measured values. In the following example the baud rate is set to 4800 baud.

<b>Setting Baud rate KERN CKE</b>	<b>Display</b>
1. Switch on balance	PRINTER?
2. Press and hold tare key	2400
3. Tap ON/OFF key and let go of tare key "Cal?" will appear on the display.	Baud 4800
4. Keep holding the switch over key „pcs ↔ g“ until "Printer" appears on the display and confirm by pressing the "20x" key. 2.400 Bd will appear on the display.	Baud 4800 Baud X 0.00 oz
5. Press the switchover key "pcs ↔ g" to select the Baud rate and confirm by the "20x" key. To return to weighing mode, press the tare key.	

## 7.4 Interface RS 232C

### Data output via interface RS 232C

#### General Information

The previous condition for the data transfer between balance and a peripheral device (e.g. printer, PC ...) is that the appliances are set to the same interface parameters (e.g. baud rate, parity ...).

### 7.4.1 There are 4 kinds of data output via RS 232C

#### Data output using the PRINT key

The printing process can be triggered by pressing the PRINT key.

The settings AUTOPRINT and AUTOPRINT PC should be disabled for this process.

#### AUTOPRINT (data output according to weight application)

The setting AUTOPRINT is located on the PRINTER path where you can turn it on or off. When AUTOPRINT is active, the current weighing value will be sent via the RS 232 data interface after unloading and subsequent loading of the balance as soon as the balance is in resting position.

#### AUTOPRINT PC (continuous data output)

The setting AUTOPRINT PC is located on the PRINTER path and where you can turn it on or off. When AUTOPRINT PC is active, the current weighing values will be sent continuously via the RS 232 data interface.

#### Data output and remote control commands

Remote control commands transferred as ASCII characters to the balance can be used to trigger the following functions on the balance (always finish with CR, LF!):

- t Taring
- w The balance sends a weighing value (also unstable) via the serial interface.
- s The balance sends a stable weighing value via the serial interface.

After receiving either character w or s, the balance will send without a printer pause between the characters.

### 7.4.2 Explanation of the data transfer

Each data transfer is structured as follows:

Bit-Nr.	1	2	3	4	5	6	7	8	9	10	11	12	13	14	15	16	17	18
	N	N	N	N	B	B	B	B	B	0	0	0	0	E	E	E	CR	LF

N	=	Numerator
B*:	=	Blank or for autotare on in zero range.
B, 0, ;, g:	=	Blank or weighing value giving unit according to loading of the balance
E	=	Unit
CR:	=	Carriage Return
LF:	=	Line Feed

### 7.4.3 Numerator

The numerator is situated under the menu item "Printer" where it can be activated or deactivated. When data output takes places via the printer key, it will be increased by one digit per key stroke.

## 7.5 Printer

The serial interface RS 232 facilitates the connection of a printer. The printout shows the weight in grams. In counting mode either the piece number or the weight details will be printed out.

In percentage mode the percentage proportion or the weight details will be printed out.

Printout will take place after pressing the PRINT key.

It is possible to number each printout continuously with the help of the numerator.

The numerator will be reset to (000) each time the balance is turned off or the CLEAR function is actuated.

## 7.6 Underfloor weighing

Objects which are unsuitable for placement on the weighing tray due to their size or shape can be weighed with the help of the underfloor weighing facility.

Proceed as follows:

- Switch off balance.
- Turn over the balance and in doing so take care that the weighing plate is not loaded.
- Open the closing lid on the bottom of your balance.
- Mount the hooks for underfloor weighing.
- Put the balance over an opening
- Suspend the goods to be weighed from the hook and carry out the weighing.

### **! Caution!**

**Pay attention that the hooks used for underfloor weighing are stable enough to provide a secure support for the desired items to be weighed (risk of breakage). Always ensure that there are no persons, animals or objects that might be damaged underneath the load.**

### **! Note!**

**After completing the underfloor weighing the opening on the bottom of the balance must always be closed (dust protection).**

## 8 Service, maintenance, disposal

### 8.1 Cleaning

Before cleaning, please disconnect the appliance from the operating voltage.

Please do not use aggressive cleaning agents (solvents or similar agents), but a cloth dampened with mild soap suds. Ensure that no liquid penetrates into the device and wipe with a dry soft cloth. Loose residue sample/powder can be removed carefully with a brush or manual vacuum cleaner.

**Spilled weighing goods must be removed immediately.**

### 8.2 Service, maintenance

The appliance may only be opened by trained service technicians who are authorized by KERN.

Before opening, disconnect from power supply.

### 8.3 Disposal

Disposal of packaging and appliance must be carried out by operator according to valid national or regional law of the location where the appliance is used.

## 9 Instant help

In case of an error in the program process, briefly turn off the balance and disconnect from power supply. The weighing process must then be restarted from the beginning.

Help:

### Fault

### Possible cause

The displayed weight does not glow.

- The balance is not switched on.
- The mains supply connection has been interrupted (mains cable not plugged in/faulty).
- Power supply interrupted.

The displayed weight is permanently changing

- Draught/air movement
- Table/floor vibrations
- Weighing plate has contact with other objects.
- Electromagnetic fields / static charging (choose different location/switch off interfering device if possible)

-

The weighing value is obviously wrong

- The display of the balance is not at zero
- Adjustment is no longer correct.
- Great fluctuations in temperature.
- Electromagnetic fields / static charging (choose different location/switch off interfering device if possible)

Should other error messages occur, switch balance off and then on again. If the error message remains inform manufacturer.

## 10 Declaration of conformity

To view the current EC/EU Declaration of Conformity go to:

[www.kern-sohn.com/ce](http://www.kern-sohn.com/ce)