

SP-2101W V3

User Manual

07-2020 / v1.0

Edimax Technology Co., Ltd.

No. 278, Xinhu 1st Rd., Neihu Dist., Taipei City, Taiwan

Email: support@edimax.com.tw

Edimax Technology Europe B.V.

Fijenhof 2, 5652 AE Eindhoven, The Netherlands

Email: support@edimax.nl

Edimax Computer Company

3444 De La Cruz Blvd., Santa Clara, CA 95054, USA

Email: support@edimax.com

Contents

I. Product Information & Safety Information.....	1
I-1. Package Contents.....	2
I-2. System Requirement	2
I-3. LED Status.....	2
I-4. Hardware Interface	3
II. EdiSmart App Installation	4
III. Register the Account.....	5
IV. Adding Devices (Android & iOS Interface)	7
V. Homepage	11
V-1. Delete a device.....	11
V-2. Info Page	13
V-3. Language	14
V-4. News.....	15
V-5. FAQ.....	15
V-6. Privacy Policy	16
V-7. Share Account	16
V-8. APP Version	17
VI. Device Setting	18
VI-1. Change the name of the device.....	18
VI-2. Upgrade Firmware	19
VII. Factory Default	20

I. Product Information & Safety Information

The Edimax Smart Plug SP-2101W V3 connects people to their homes and the things they use every day. With the Edimax Smart Plug you can control most home appliances and check the Power Meter, from anywhere anytime with the EdiSmart App.

Please install the unit with the safety restrictions outlined below:

- Maximum Power Rating must not be exceeded in order to guarantee the lifespan and reliability of.
- Children should not use this product without adult supervision.
- This product does not have lightning protection. It is recommended to turn off the power when lightning strikes.
- When the smart plug is powered on, do not insert conductive materials into the socket.



Unable to follow the above mentioned guideline may reduce smart plug lifetime.

You can find all supporting documents from the link below or via QR Code:

<https://www.edimax.com/download>



(Once you've visited the Edimax official website, please enter model no. "SP-2101W V3" into the search box to search for your product.)

Download

To select your product and find related download materials, enter the model number into the search box on the right side or follow the simple steps below:

*Feel free to contact us anytime if you need help or if you can't find your product.

Model no.

[How do I find the model number?](#)

I-1. Package Contents

Before using this product, please check if anything is missing from the packaging, and contact your dealer to claim the missing item(s):

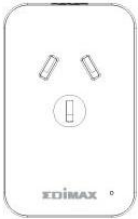

AU



EU



US



UK



**Quick Installation
Guide**

I-2. System Requirement

- Wi-Fi: 2.4 GHz 802.11 b/g/n
- Android 6 or later
- iOS 11 or later

I-3. LED Status

LED Name	Color	Status	Description
Power LED	Blue	Blinking	Power on and before provision
		Off	After provision
		On	Power switch on

I-4. Hardware Interface

US Smart Plug:

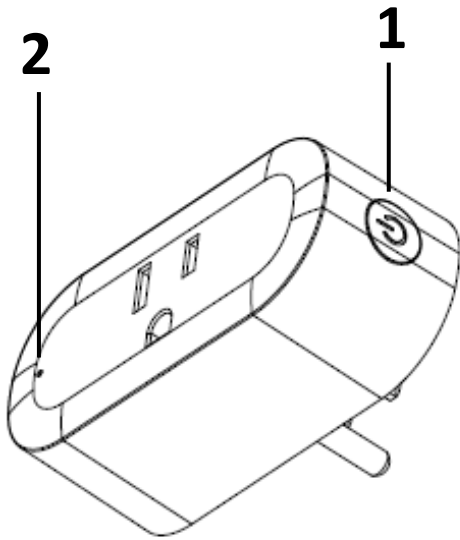

AU Smart Plug:

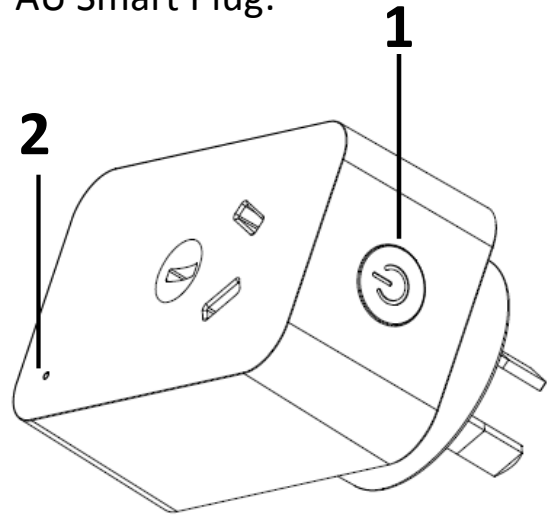

EU Smart Plug:

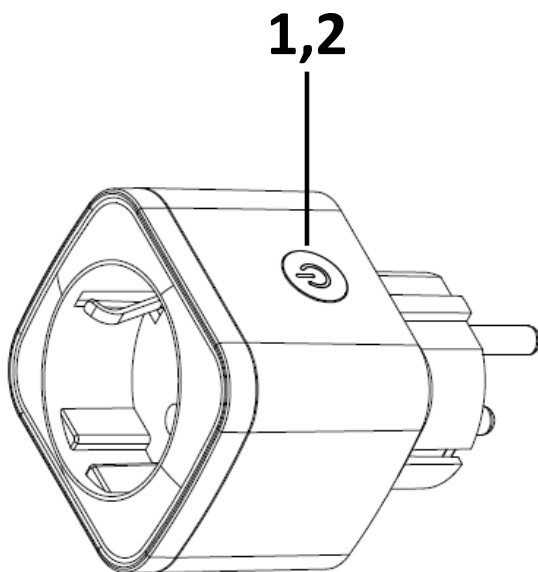

UK Smart Plug

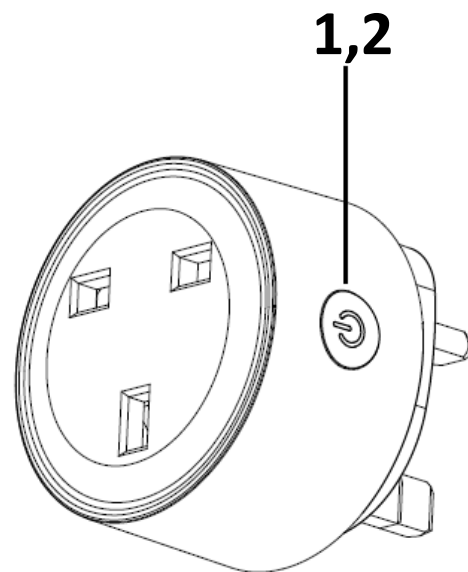

No.	Description
1	Power Button
2	LED

II. EdiSmart App Installation

Search and download "EdiSmart" in App Store (iOS) / Google Play Store (Android) or scan the QR code below. Launch the "EdiSmart" in your smart mobile device.



Before using EdiSmart app, please make sure,

- Your mobile device can access the internet.

NOTE: Only 2.4 GHz Wi-Fi networks are supported. Please select a 2.4 GHz Wi-Fi network.



- Go to your phone's system language, and select the language you want to use for app. For example, if you change the language of your phone to English, then your app should automatically display the language you selected.

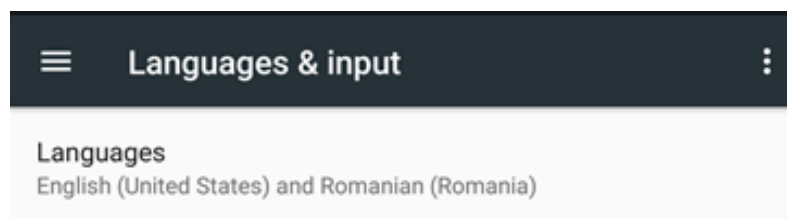

III. Register the Account

Please follow the steps below to register the account,

1. Launch the EdiSmart App in your device and click the “Sign up” button to register an account with your email.

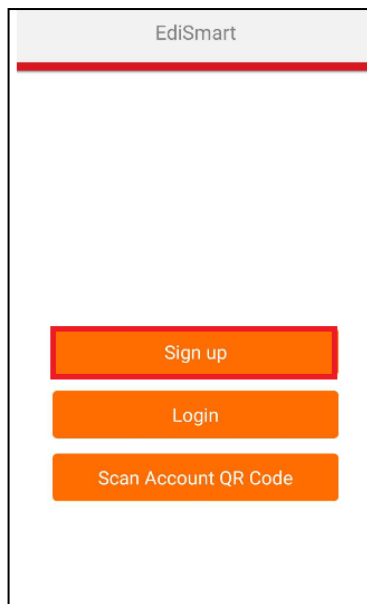

2. Read the preamble and click “Yes” to proceed the next step.

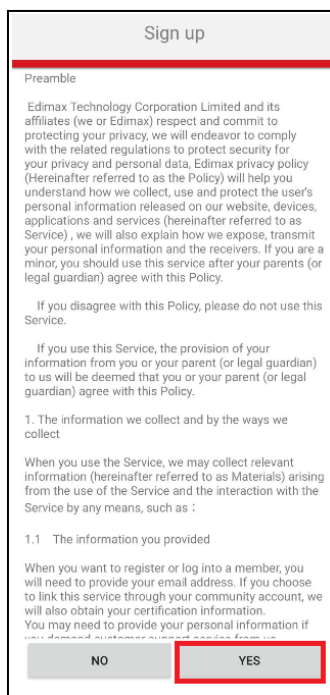

3. Enter your Email and Password. Click the “Sign up” button to proceed the next step.

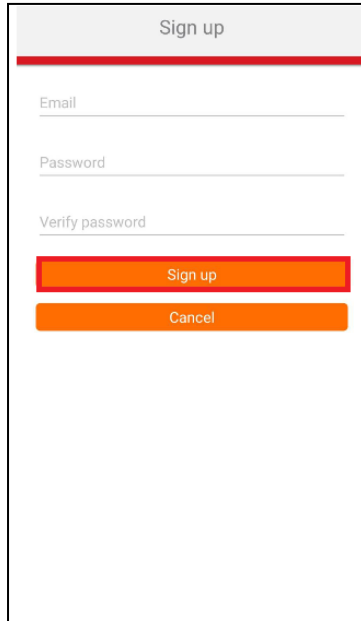

A vertical sign-up form with a light gray header containing the text "Sign up". Below the header are three input fields: "Email", "Password", and "Verify password". At the bottom of the form are two buttons: a red "Sign up" button and an orange "Cancel" button.

4. Please check your email and click the “Confirm Your Email” button.

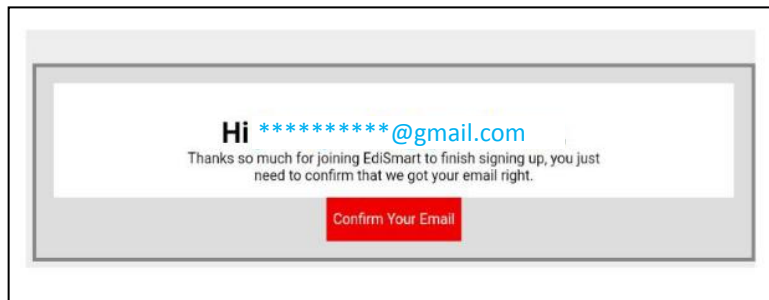

Note: You will receive a message, “Congratulation! You have been successfully registered.” If the account is successfully created

IV. Adding Devices (Android & iOS Interface)

Please follow the steps below to add a new device.

1. Click the “Login” button. Enter your Email/Password and click the “Login” button.

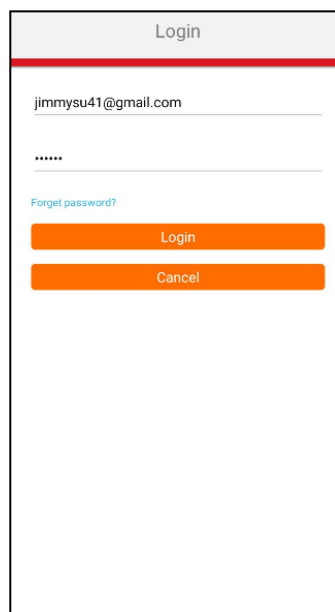
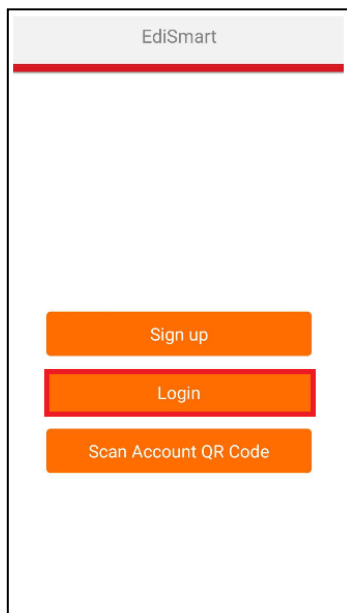

2. Click the “+” icon in the top right corner.

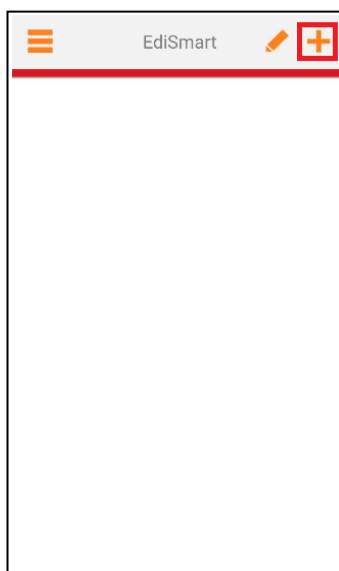

3. Click “Add New Devices”.

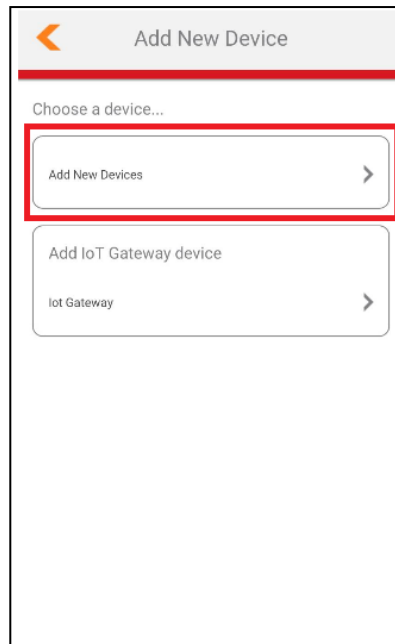

4. Follow the instruction on screen and enter the last two digits of MAC. Click the “Make sure the Status LED indicator blinks” button to confirm.

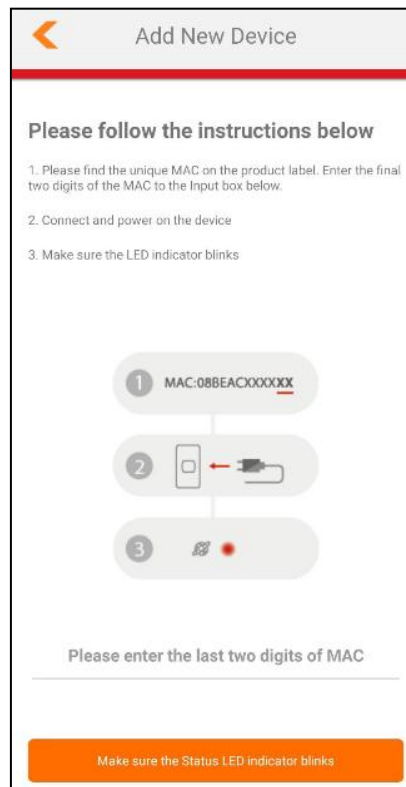

NOTE: Please make sure Wi-Fi is on all the time.

- Select the device that you wish to connect to the EdiSmart and click “Connect” or “Join”.

Android

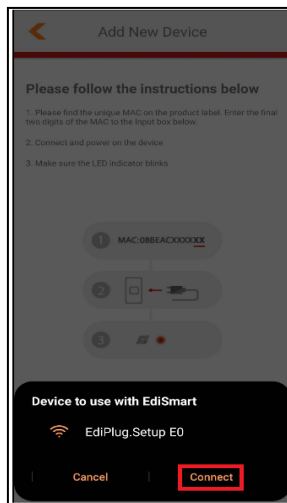

iOs

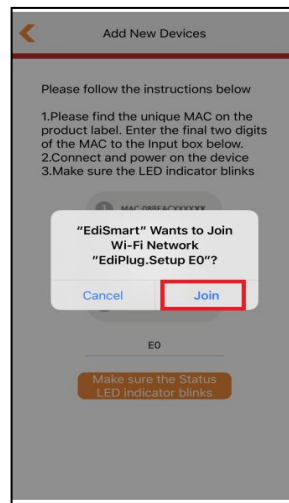

- Select a Wi-Fi SSID to connect and enter the Wi-Fi password.

Android Interface:

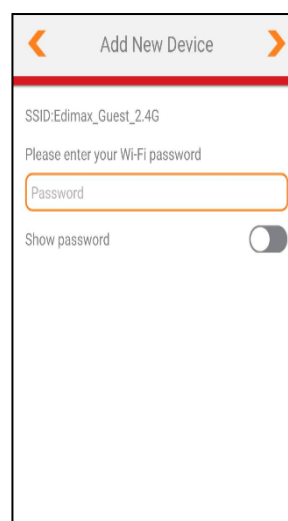
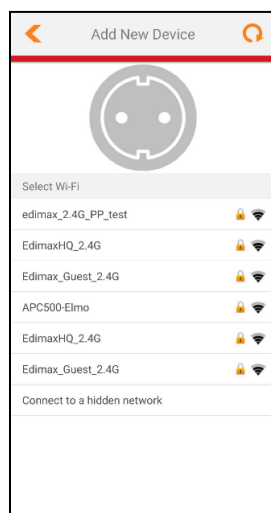

iOS Interface:

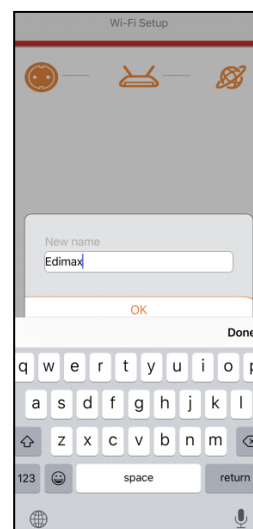
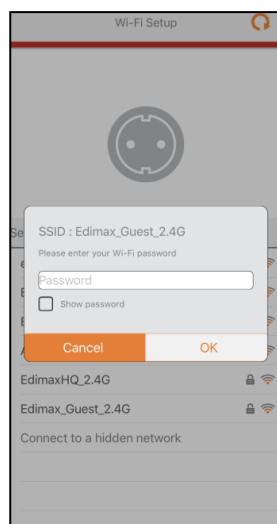

7. Wait for the smart plug to connect to the EdiSmart. And enter a device name and click “Done”.

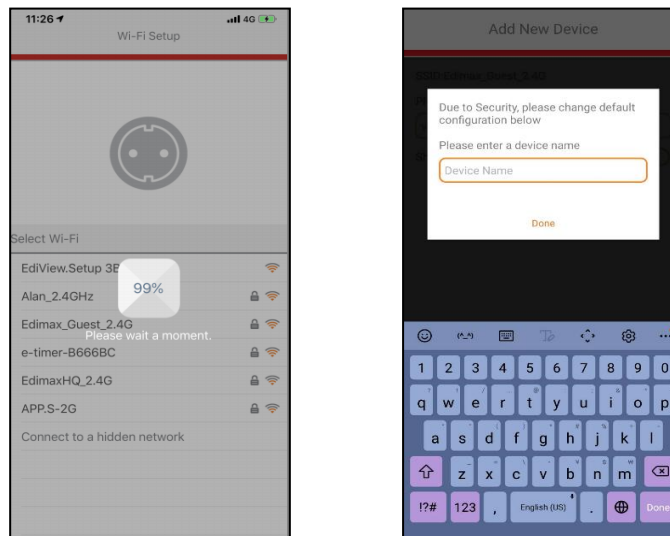

Congratulation! You are finished with the installation.

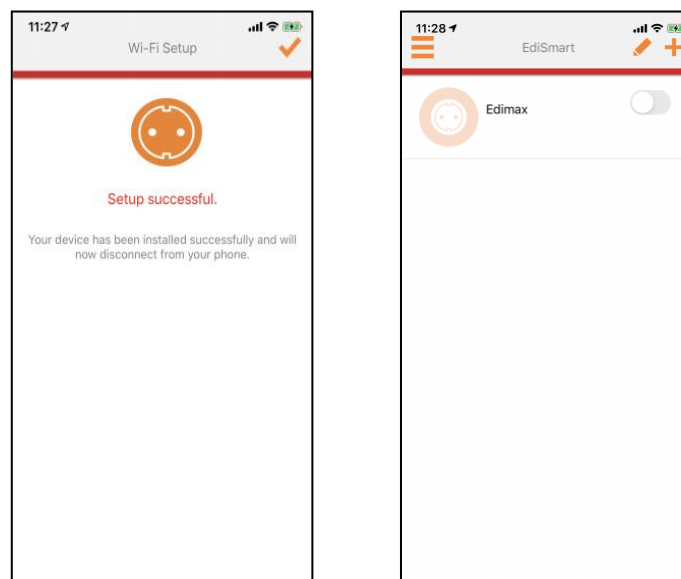

V. Homepage

In this page you can manage your device from the info page, add or remove the devices.

V-1. Delete a device

Please follow the steps below to remove the device from the list,

1. Tap the  icon,

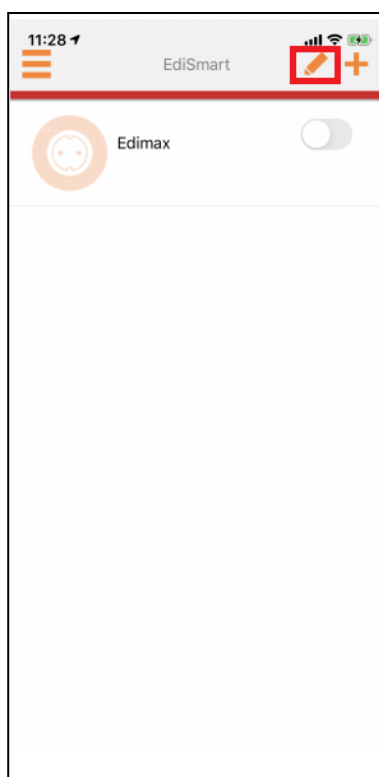

2. Tap the  sign on the left.

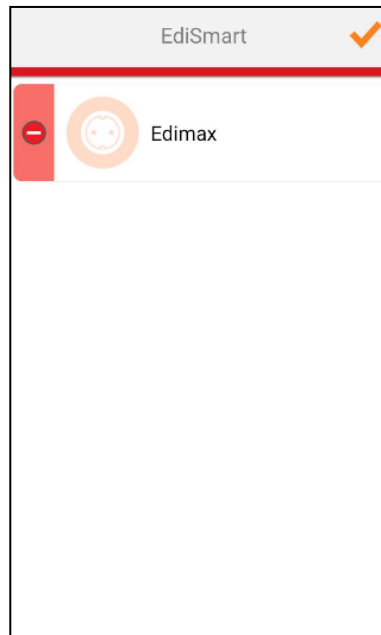

3. Click Yes.

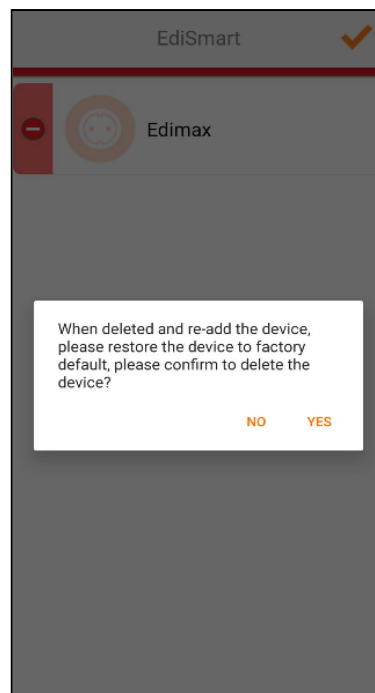

4. Click the save button to save the change.

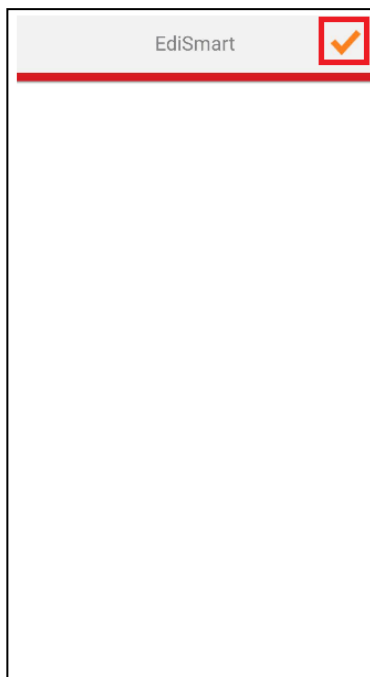

V-2. Info Page

Tap the  to check the info page. The info page includes Language, News, FAQ, Privacy Policy, Share Account and APP Version.

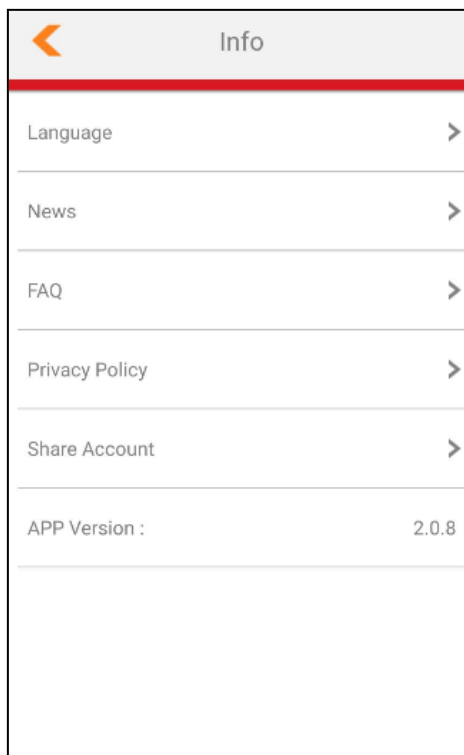
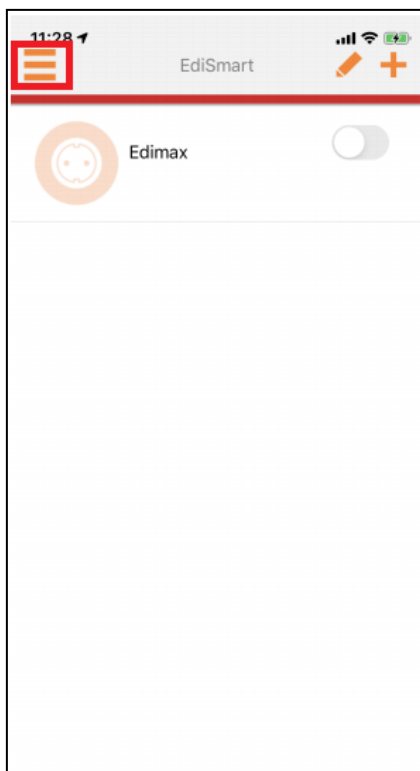

V-3. Language

Please follow the steps below to change the language of the APP,

1. Tap Language.

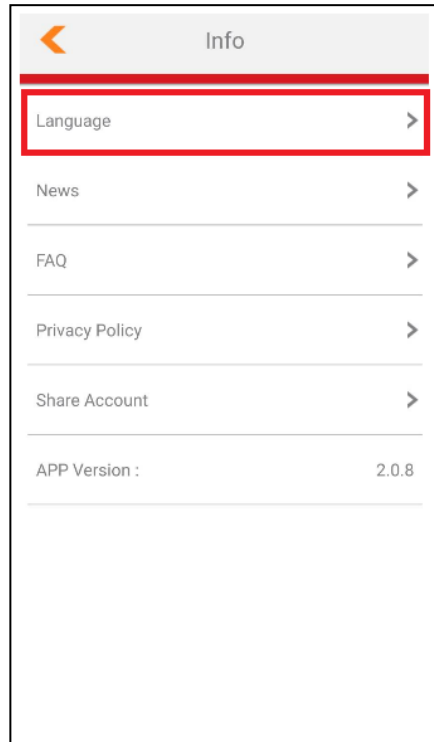

2. Pick a language from the list.



V-4. News

Please follow the step below to check the latest News of Edimax,

Tap News to view the News page of Edimax.

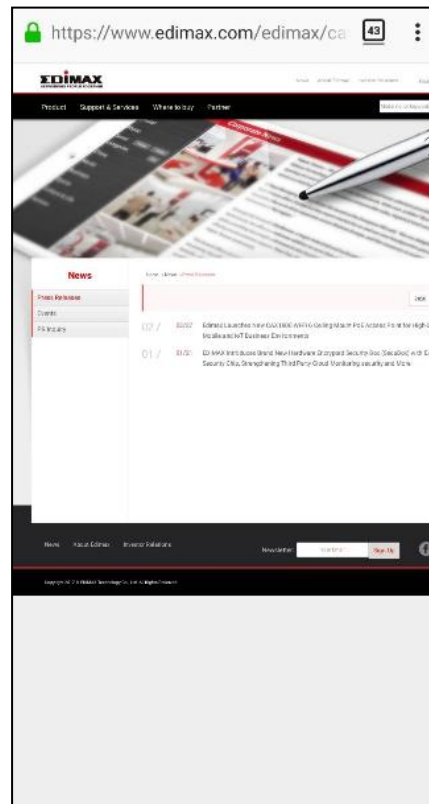
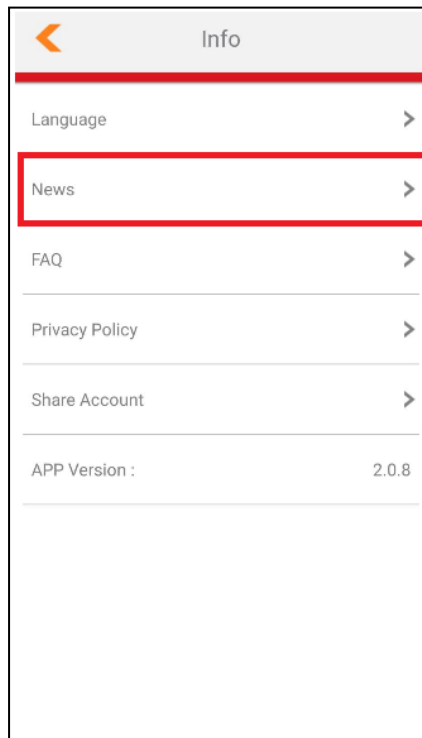

V-5. FAQ

Please follow the step below to enter the FAQ page of Edimax,

Tap FAQ to access the FAQ page of Edimax

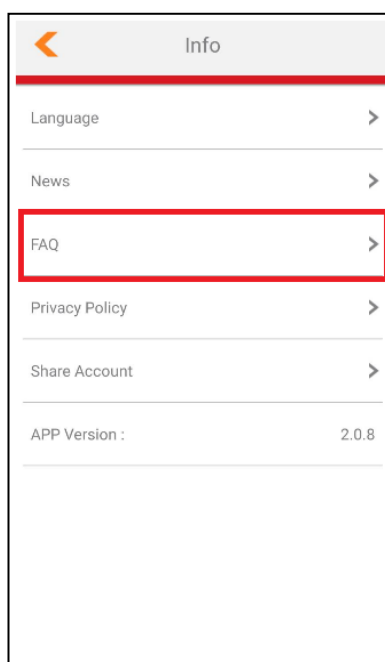

V-6. Privacy Policy

To view privacy policy, please tap Privacy Policy

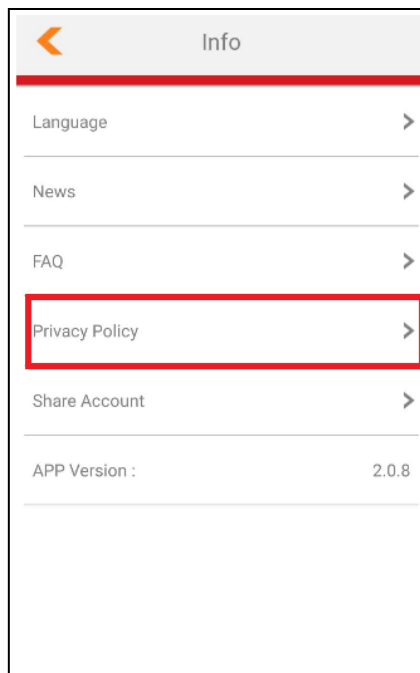

V-7. Share Account

In this page you can share your account with the other user.
Please follow the steps below,

1. Tap Share Account, QR code will pop up. User can scan the QR code to log in your account.

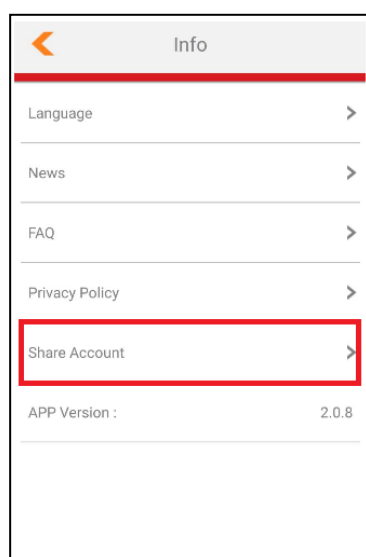

2. Click Scan Account QR Code on the login page.

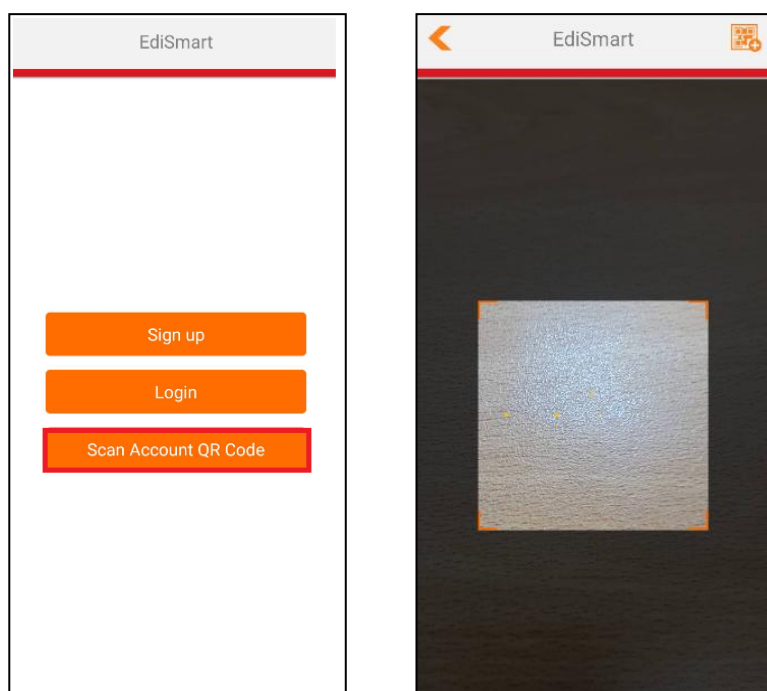

V-8. APP Version

You can check the APP version in info page.

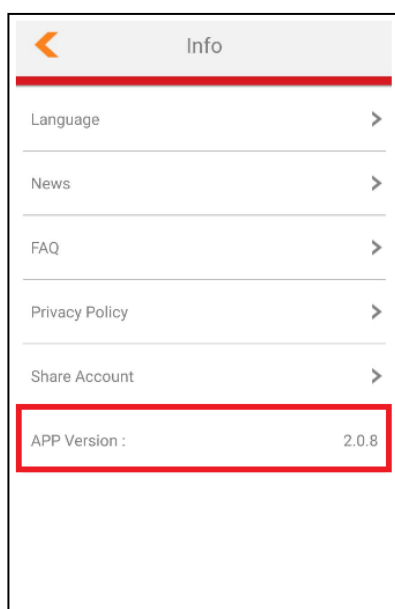

VI. Device Setting

In device setting page you can change the device name, upgrade firmware and reset to default. Click the top right icon  on the device page.

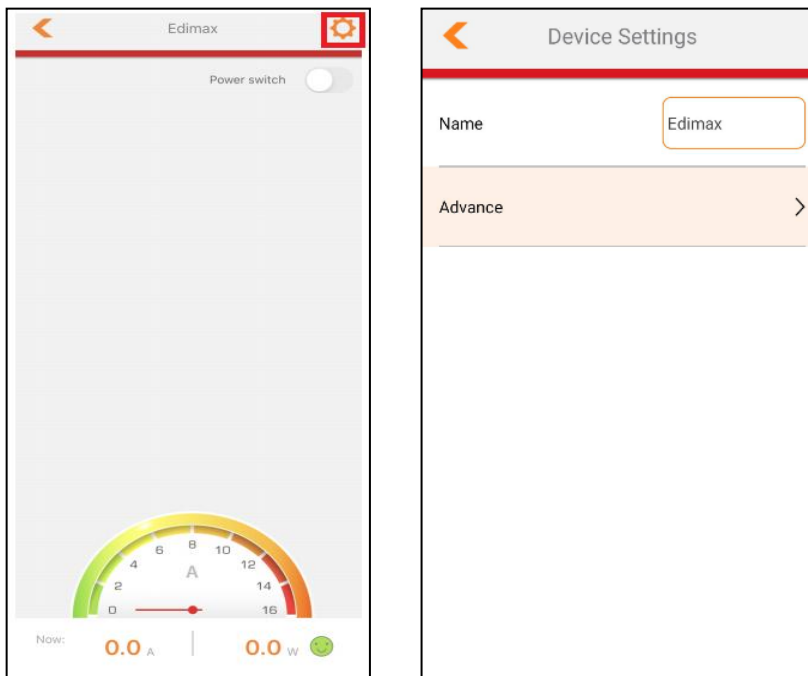

VI-1. Change the name of the device

Please follow the steps below to change the name of your device,

1. Tap the new name of your device and tap OK.

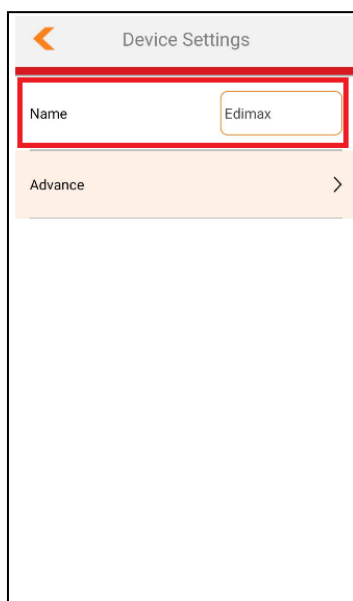

2. Rename your device, then tap OK.

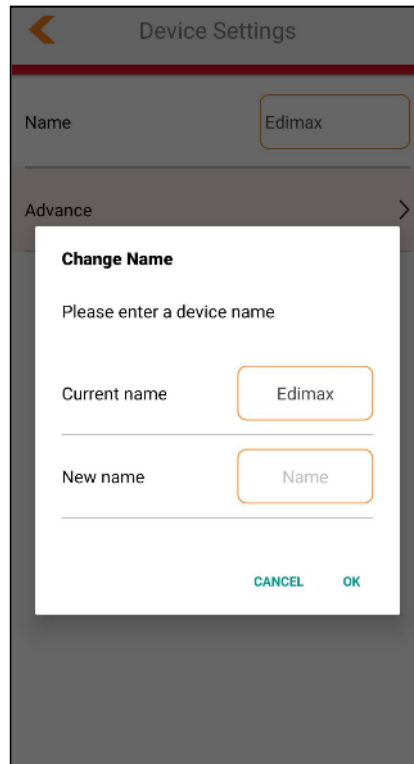

VI-2. Upgrade Firmware

Tap Check to upgrade the firmware.

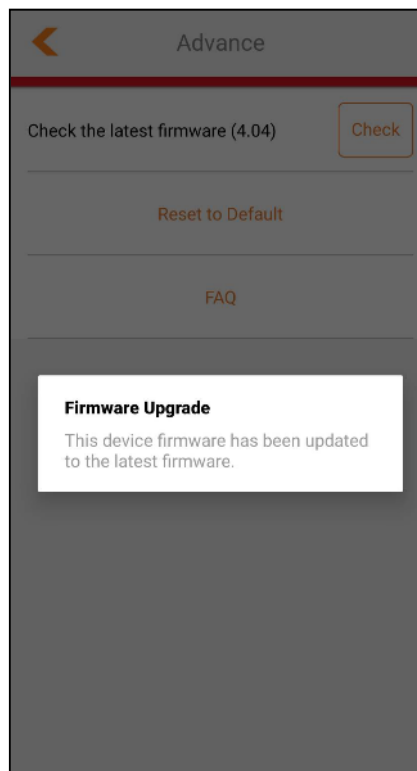

VII. Factory Default

If you experience problems with your smart plug, you can reset the device back to its factory settings.

There are 2 ways to reset the device.

Hardware Reset:

1. Press and hold the power button for 10-15 seconds, release the button when the power LED flashes quickly in **blue**.
2. When the power LED blinks slowly in **blue**, it is ready for setup.

Software Reset:

1. Click the top right  icon on the device page.

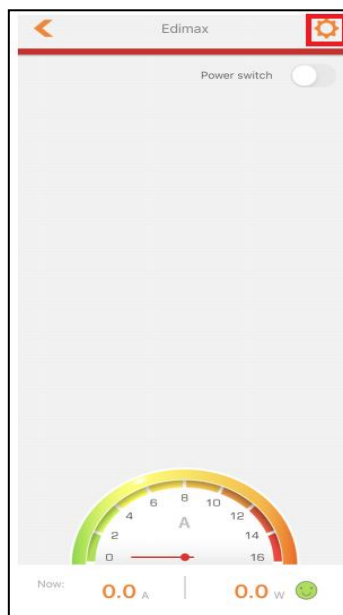

Click Advance and “Reset to Default” button.

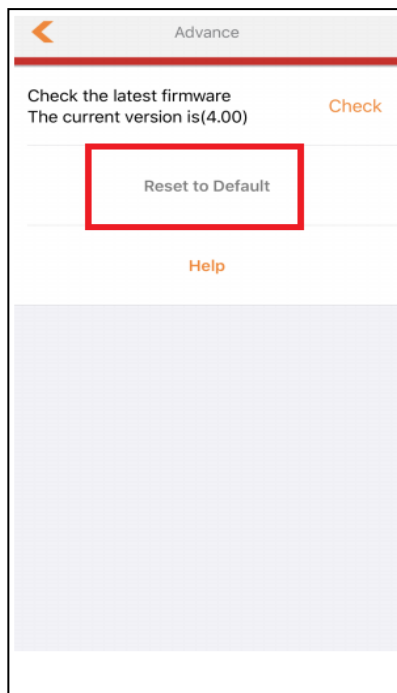
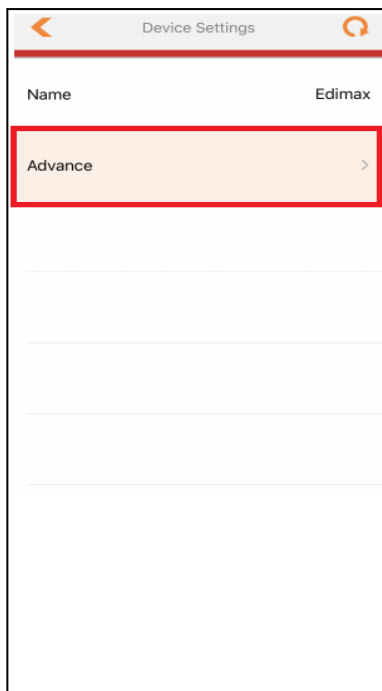

COPYRIGHT

Copyright © Edimax Technology Co., Ltd. all rights reserved. No part of this publication may be reproduced, transmitted, transcribed, stored in a retrieval system, or translated into any language or computer language, in any form or by any means, electronic, mechanical, magnetic, optical, chemical, manual or otherwise, without the prior written permission from Edimax Technology Co., Ltd.

Edimax Technology Co., Ltd. makes no representations or warranties, either expressed or implied, with respect to the contents hereof and specifically disclaims any warranties, merchantability, or fitness for any particular purpose. Any software described in this manual is sold or licensed as is. Should the programs prove defective following their purchase, the buyer (and not this company, its distributor, or its dealer) assumes the entire cost of all necessary servicing, repair, and any incidental or consequential damages resulting from any defect in the software. Edimax Technology Co., Ltd. reserves the right to revise this publication and to make changes from time to time in the contents hereof without the obligation to notify any person of such revision or changes.

The product you have purchased and the setup screen may appear slightly different from those shown in this QIG. The software and specifications are subject to change without notice. Please visit our website www.edimax.com for updates. All brand and product names mentioned in this manual are trademarks and/or registered trademarks of their respective holders.

Federal Communication Commission Interference Statement

This equipment has been tested and found to comply with the limits for a Class B digital device, pursuant to Part 15 of FCC Rules. These limits are designed to provide reasonable protection against harmful interference in a residential installation. This equipment generates, uses, and can radiate radio frequency energy and, if not installed and used in accordance with the instructions, may cause harmful interference to radio communications. However, there is no guarantee that interference will not occur in a particular installation. If this equipment does cause harmful interference to radio or television reception, which can be determined by turning the equipment off and on, the user is encouraged to try to correct the interference by one or more of the following measures:

1. Reorient or relocate the receiving antenna.
2. Increase the separation between the equipment and receiver.
3. Connect the equipment into an outlet on a circuit different from that to which the receiver is connected.
4. Consult the dealer or an experienced radio technician for help.

FCC Caution

Any changes or modifications not expressly approved by the party responsible for compliance could void the authority to operate equipment.

This device complies with Part 15 of the FCC Rules. Operation is subject to the following two conditions: (1) this device may not cause harmful interference, and (2) this device must accept any interference received, including interference that may cause undesired operation.

FCC Radiation Exposure Statement:

This equipment complies with FCC radiation exposure limits set forth for an uncontrolled environment. This equipment should be installed and operated with minimum distance 20cm between the radiator & your body. For product available in the USA/Canada market, only channel 1~11 can be operated. Selection of other channels is not possible. This device and its antenna(s) must not be co-located or operating in conjunction with any other antenna or transmitter.

RED Compliance Statement

Compliance with 2014/53/EU Radio Equipment Directive (RED)

In accordance with Article 10.8(a) and 10.8(b) of the RED, the following table provides information on the frequency bands used and the maximum RF transmit power of the product for sale in the EU:

Frequency range (MHz)	Max. Transmit Power (dBm)
2412-2472	16.70

A simplified DoC shall be provided as follows: Article 10(9)

Hereby, Edimax Technology Co., Ltd. declares that the radio equipment type **Wi-Fi Smart Plug** is in compliance with Directive 2014/53/EU

The full text of the EU declaration of conformity is available at the following internet address: <http://www.edimax.com/edimax/global/>

Safety

This equipment is designed with the utmost care for the safety of those who install and use it. However, special attention must be paid to the dangers of electric shock and static electricity when working with electrical equipment. All guidelines of this and of the computer manufacture must therefore be allowed at all times to ensure the safe use of the equipment.

EU Countries Intended for Use

The ETSI version of this device is intended for home and office use in Austria, Belgium, Bulgaria, Cyprus, Czech, Denmark, Estonia, Finland, France, Germany, Greece, Hungary, Ireland, Italy, Latvia, Lithuania, Luxembourg, Malta, Netherlands, Poland, Portugal, Romania, Slovakia, Slovenia, Spain, Sweden, Turkey, and United Kingdom. The ETSI version of this device is also authorized for use in EFTA member states: Iceland, Liechtenstein, Norway, and Switzerland.

EU Countries Not Intended for Use

None

EU Declaration of Conformity

- English:** This equipment is in compliance with the essential requirements and other relevant provisions of Directive 2014/53/EU, 2014/35/EU.
- Français:** Cet équipement est conforme aux exigences essentielles et autres dispositions de la directive 2014/53/EU, 2014/35/EU.
- Čeština:** Toto zařízení je v souladu se základními požadavky a ostatními příslušnými ustanoveními směrnic 2014/53/EU, 2014/35/EU.
- Polski:** Urządzenie jest zgodne z ogólnymi wymaganiami oraz szczególnymi warunkami określonymi Dyrektywą UE 2014/53/EU, 2014/35/EU.
- Română:** Acest echipament este în conformitate cu cerințele esențiale și alte prevederi relevante ale Directivei 2014/53/UE, 2014/35/UE.
- Русский:** Это оборудование соответствует основным требованиям и положениям Директивы 2014/53/EU, 2014/35/EU.
- Magyar:** Ez a berendezés megfelel az alapvető követelményeknek és más vonatkozó irányelveknek (2014/53/EU, 2014/35/EU).
- Türkçe:** Bu cihaz 2014/53/EU, 2014/35/EU direktifleri zorunlu istekler ve diğer hükümlerle ile uyumludur.
- Українська:** Обладнання відповідає вимогам і умовам директиви 2014/53/EU, 2014/35/EU.
- Slovenčina:** Toto zariadenie spĺňa základné požiadavky a ďalšie príslušné ustanovenia smerníc 2014/53/EU, 2014/35/EU.
- Deutsch:** Dieses Gerät erfüllt die Voraussetzungen gemäß den Richtlinien 2014/53/EU, 2014/35/EU.
- Español:** El presente equipo cumple los requisitos esenciales de la Directiva 2014/53/EU, 2014/35/EU.
- Italiano:** Questo apparecchio è conforme ai requisiti essenziali e alle altre disposizioni applicabili della Direttiva 2014/53/EU, 2014/35/UE.
- Nederlands:** Dit apparaat voldoet aan de essentiële eisen en andere van toepassing zijnde bepalingen van richtlijn 2014/53/EU, 2014/35/EU.
- Português:** Este equipamento cumpre os requisitos essenciais da Directiva 2014/53/EU, 2014/35/EU.
- Norsk:** Dette utstyret er i samsvar med de viktigste kravene og andre relevante regler i Direktiv 2014/53/EU, 2014/35/EU.
- Svenska:** Denna utrustning är i överensstämmelse med de väsentliga kraven och övriga relevanta bestämmelser i direktiv 2014/53/EU, 2014/35/EU.
- Dansk:** Dette udstyr er i overensstemmelse med de væsentligste krav og andre relevante forordninger i direktiv 2014/53/EU, 2014/35/EU.
- suomen kieli:** Tämä laite täyttää direktiivien 2014/53/EU, 2014/35/EU. oleelliset vaatimukset ja muut asiaankuuluvat määräykset.

FOR USE IN 



WEEE Directive & Product Disposal



At the end of its serviceable life, this product should not be treated as household or general waste. It should be handed over to the applicable collection point for the recycling of electrical and electronic equipment, or returned to the supplier for disposal.

Declaration of Conformity

We, Edimax Technology Co., Ltd., declare under our sole responsibility, that the equipment described below complies with the requirements of the European Radio Equipment directives.

Equipment: Wi-Fi Smart Plug
Model No.: SP-2101W V3

The following European standards for essential requirements have been followed:

Directives 2014/53/EU

Spectrum : ESTI EN 300 328 V2.1.1:2016
EMC : Draft EN 301 489-1 V2.0.0:2017
Draft EN 301 489-17 V3.2.0:2017
EMF : EN 62311:2008
Safety (LVD) : IEC 62368-1:2014 (2nd Edition); and/or EN 2368-1:2014/A11:2017

Edimax Technology Europe B.V.
Fijenhof 2,
5652 AE Eindhoven,
The Netherlands

a company of :
Edimax Technology Co., Ltd.
No. 278, Xinhua 1st Rd.,
Neihu Dist., Taipei City,
Taiwan

Signature:

Printed Name: David Huang
Title: Director
Edimax Technology Europe B.V.



Date of Signature: July, 2020

Signature: _____

Printed Name: Albert Chang

Title: Director
Edimax Technology Co., Ltd.