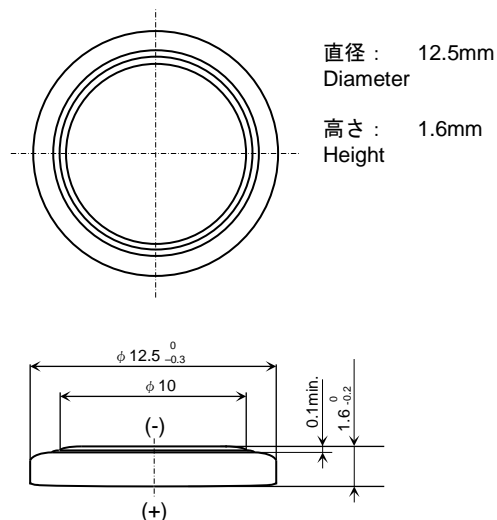
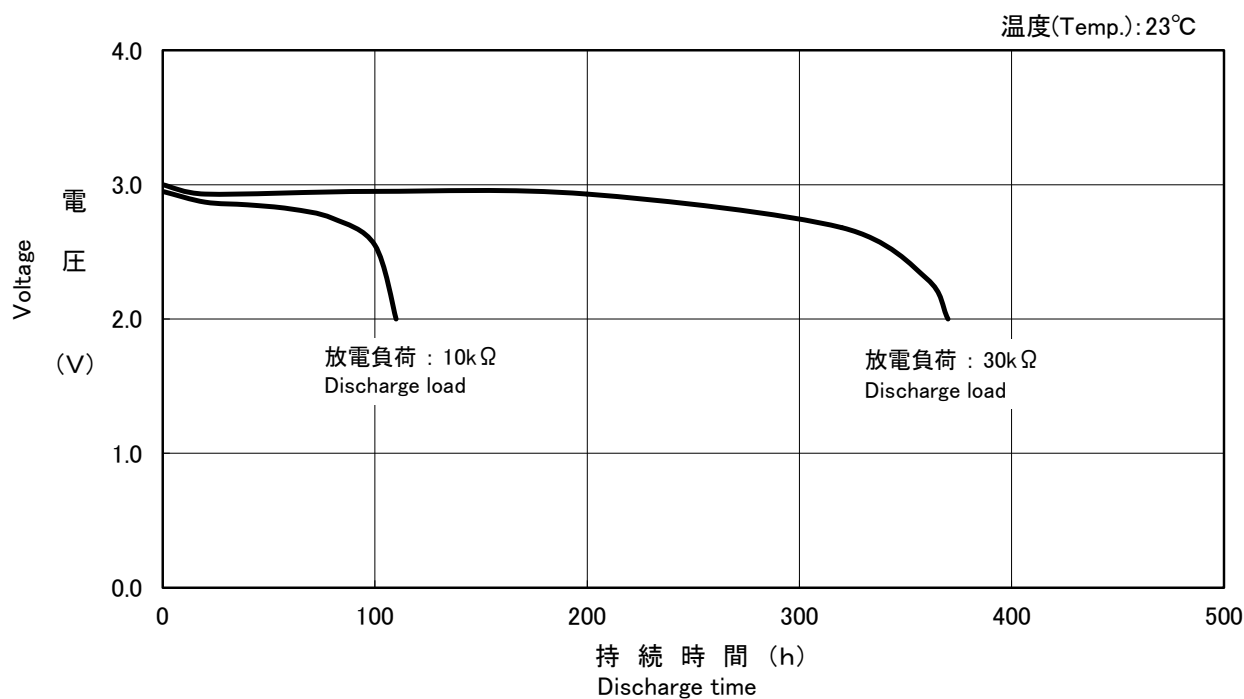

コイン形二酸化マンガンリチウム電池  
 Coin manganese dioxide lithium batteries

# CR1216

**■外形寸法** Dimensions(mm)

**■定格** Specifications

公称電圧 <b>Nominal Voltage</b>	3 V
公称容量 (終止電圧 2.0V) <b>Nominal Capacity (2.0V cutoff)</b>	30 mAh
標準放電電流値 <b>Standard Discharge Current</b>	0.1 mA
標準質量 <b>Weight</b>	0.67 g
使用温度範囲 <b>Operating Temperature</b>	-30 ~ +70°C
<b>用途 Applications</b>	
<ul style="list-style-type: none"> <li>● 時計</li> <li>● 電子手帳・電卓</li> <li>● SRAMやリアルタイムクロック等メモリーバックアップ</li> <li>● Electronic Watch or Clock</li> <li>● Electronic Calculator</li> <li>● Memory Back-up Power Source for SRAM or Real Time Clock (RTC)</li> </ul>	
<b>UL認定合格部品 UL Recognized components</b>	
<ul style="list-style-type: none"> <li>● 許可番号 <b>Certification number</b> : MH12566</li> <li>● User replaceable</li> </ul>	

**■放電特性** Discharge Characteristics

■放電負荷特性

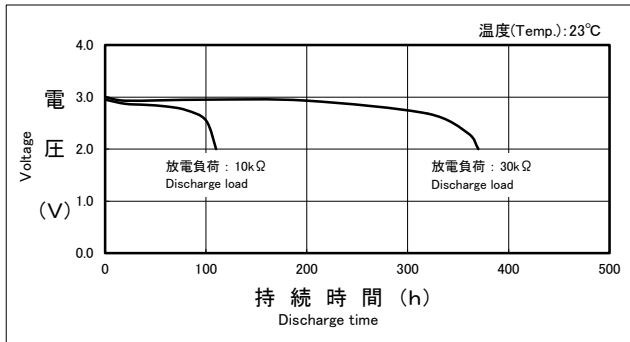
Discharge Characteristics on Load



■放電温度特性

Discharge Characteristics on Temperature

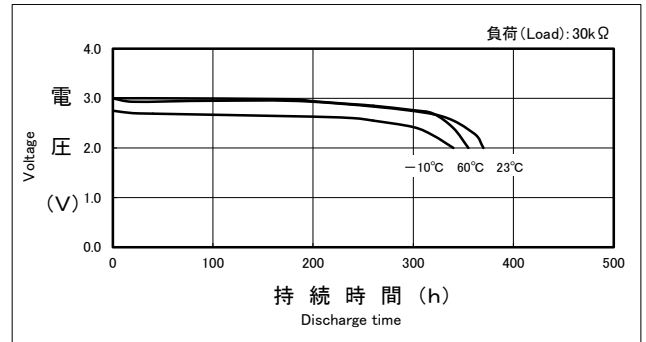

■放電負荷と作動電圧 (放電深度 40%時の電圧)

Discharge Load vs. Operation Voltage (Discharge depth 40%)

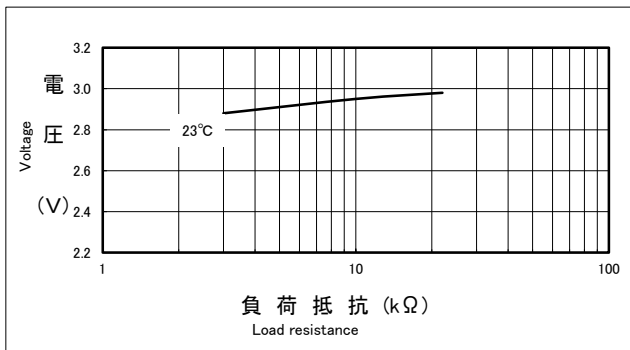

■放電負荷と電気容量

Discharge Load vs. Discharge Capacity

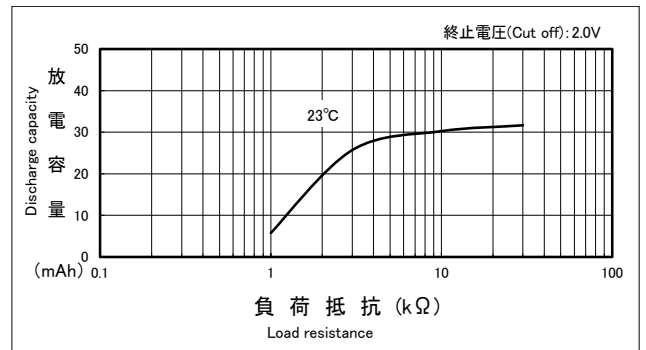

■パルス放電特性 (放電深度 40%時のパルス電圧)

Discharge Characteristics on Pulse Load (Discharge depth 40%)

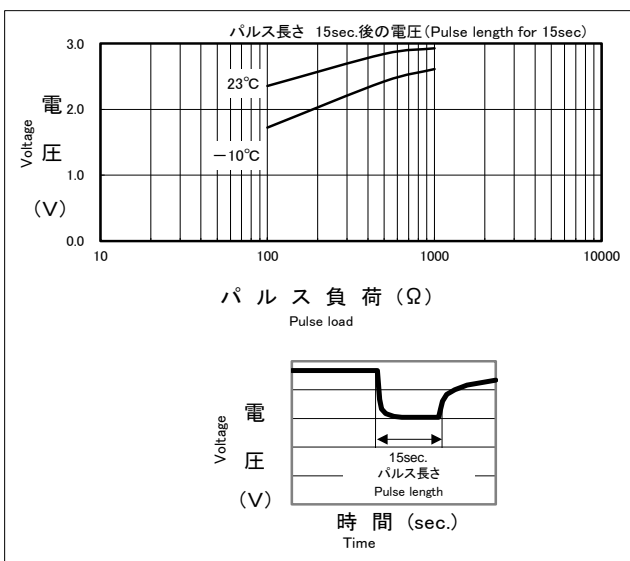

■保存特性

Storage Characteristics

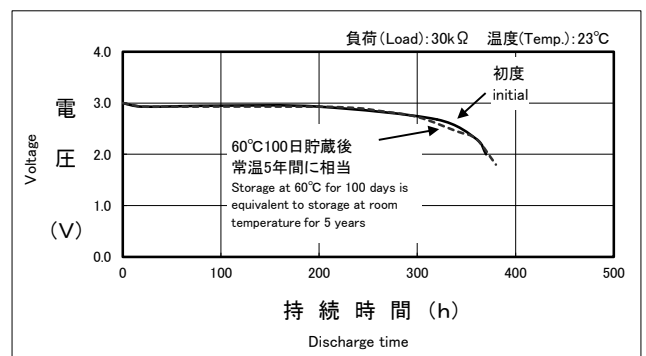

\*記載のデータ及び数値は、参考値であり保証値ではありません。

\*Data is not guaranteed, and is provided for reference purposes only.