



# MV88plus Video

MV88+ Video Kit

The ShurePlus MV88 video app user guide.  
Version: 4.1 (2021-I)

# Table of Contents

<b>MV88plus Video MV88+ Video Kit</b>	<b>3</b>	<b>Using the Apple Watch with ShurePlus MOTIV</b>	<b>12</b>
<b>General Description</b>	<b>3</b>	Connect your Apple Watch to the MOTIV recording app.	1 2
Features	3	Controls and Navigation	13
<b>Standby Mode</b>	<b>3</b>	<b>Recording Tips</b>	<b>13</b>
Visual Settings	4	Turn Off Notifications	13
Record Mode	4	Adjust your Sample Rate	13
<b>Using the ShurePlus MOTIV™ App with the MV88+ microphone</b>	<b>5</b>	Get the Best-looking Video Image	13
Aiming the Microphone	5	Record in Mono	13
MV88+ Outputs	8	Record in Stereo	13
<b>Device Setup</b>	<b>8</b>	Capture the Complete Performance	13
Preset Modes	10	Record with Confidence with Automatic Save	14
Direct Monitoring Blend	11	<b>Sharing MOTIV Video Recordings</b>	<b>14</b>
<b>Advanced Mic Settings</b>	<b>11</b>	<b>Troubleshooting</b>	<b>14</b>
Limiter	11	<b>System Requirements</b>	<b>15</b>
Compressor	11	System Requirements and Compatibility: iOS	15
High Pass Filter	11	System Requirements and Compatibility: Android	15
Left-Right Channel Swap	12	<b>Specifications</b>	<b>15</b>
Equalizer	12	Supported Audio Formats	17
		<b>Certifications</b>	<b>17</b>

# MV88plus Video

## MV88+ Video Kit

## General Description

The Shure® MV88+ Video recording app provides instant video recording with uncompressed audio for your mobile device. Customize the sound with digital signal processing (DSP) preset modes, adjustable gain, and stereo width control.

## Features

- Compatible with iOS, Android, PC and Mac devices.

**Note:** See <https://www.shure.com/MOTIVcompatibility> for information on recommended Android devices.

- Plug-and-Play Operation supporting landscape and portrait recording
- Flexible Recording Control includes gain adjustment settings
- Support for mono and stereo audio devices
- When used with MOTIV microphones, preset modes are available for a variety of recording situations.

**Tip:** Turn on Airplane Mode and Do Not Disturb to prevent interruptions to the recording caused by phone calls, text messages, or alerts.

## Standby Mode

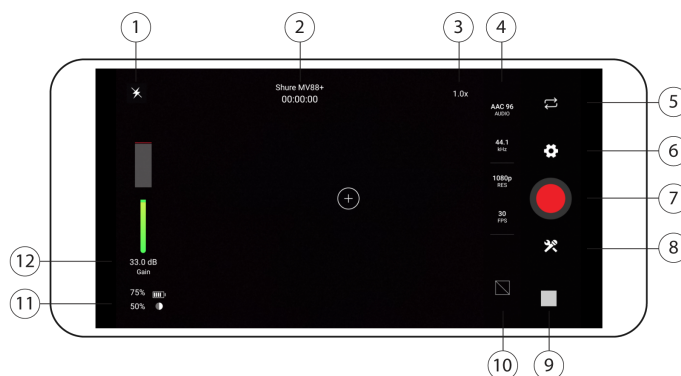

① **Flash** Use the flash when recording in low light situations.

② **Connected Device Status/Recording Length/Focus Lock** Device status will display the model name of the connected MOTIV device. Recording length is displayed in hours, minutes, and seconds. See the Visual Settings topic for more information on setting focus and exposure.

③ **Zoom Level** Pinch the screen to adjust your zoom level for a closer view of your subject.

④ **File Information** Displays available video format options.

**Note:** Option availability may vary based on your mobile device specifications.

- **Audio file formats:** (iOS) WAV, ALAC, AAC 96, AAC 128, AAC 256 (Android) AAC 96, AAC 128, AAC 256

- **Sample rate:** 44.1 kHz, 48 kHz
- **Video resolution:** 720p, 1080p, 4K
- **Frame rate:** 24 fps, 30 fps, 60 fps

⑤ **Reverse Camera** Use the front-facing camera to shoot selfie videos.

⑥ **Settings** Tap the app settings sprocket to select light or dark theme appearance, to find version information, help materials, and to send feedback.

⑦ **Record/Stop Button**

⑧ **Device Setup** Access advanced settings for your audio device. See Device Setup section for more information.

⑨ **Preview Window** Tap to review the most recently recorded video.

⑩ **Grid/Level/Off Display** Tap through to display grid lines or a level for easy image composition. Or turn this feature off if you prefer a clean display.

⑪ **Device Status** Displays remaining battery life and available storage space for your recording device.

⑫ **Input Meter/Microphone Gain** Displays the strength of the mono or stereo input signal. Tap the input meter to bring up the mic gain and direct monitoring sliders. You can adjust microphone gain during recording to match the volume of the sound source. Make live adjustments to ensure levels are in the target range (indicated by the shaded region of the input meter).

**Note:** Display will read AGC when using the app with the built-in microphone. Automatic Gain Control (AGC) adjusts levels to ensure consistent volume. Weaker signals are boosted and stronger signals are attenuated to control gain. The dynamic range is decreased but the result is a more even recording.

## Visual Settings

Be sure to adjust your visual settings to get the best-looking video image. We recommend making adjustments in this order.

**Zoom:** Pinch to zoom in or out and frame your shot.

**Brightness:** Swipe up and down to set brightness level.



**Focus:** Tap to focus or tap and hold to lock brightness and focus. Tap again to release the lock.



## Record Mode

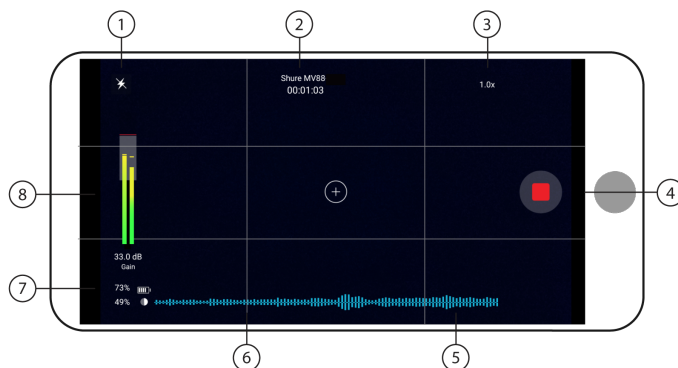

① **Flash** Use the flash when recording in low light situations.

② **Connected Device Status/Recording Length/Focus Lock** Status will display the model name of the connected MOTIV device. Recording length is displayed in hours, minutes, and seconds. The red dot will flash when video is recording. See the Visual Settings topic for more information on focus and exposure.

③ **Zoom Level** Pinch the screen to adjust your zoom level for a closer view of your subject.

④ **Record/Stop Button** Start and stop video recording.

**Note:** Video files are saved to the Photos app on your mobile device.

⑤ **Audio Recording** The MOTIV Video app displays the audio waveform as it is being recorded.

⑥ **Grid** Use the grid lines to assist in composing your image.

⑦ **Device Status** Displays remaining battery life and available storage space for your recording device.

⑧ **Input Meter** Displays the strength of the mono or stereo input signal. Tap the input meter to bring up the mic gain and direct monitoring sliders. You can adjust microphone gain during recording to match the volume of the sound source. Make live adjustments to ensure levels are in the target range (indicated by the shaded region of the input meter).

**Note:** The maximum file size for a recording is 2GB, which will result in approximately 2 hours of record time. This limitation was put in place to maximize app performance. Continuous recording for more than 2 hours will generate a second file.

---

## Using the ShurePlus MOTIV™ App with the MV88+ microphone

The MOTIV app controls microphone settings to optimize performance for specific uses. The device stores the most recently used settings for quick setup each time you record.

### Aiming the Microphone

The following suggestions are for typical use cases. Keep in mind that there are many effective ways to record a source. Experiment with horizontal or landscape orientation, microphone placement and settings to find what works best for you.

#### Portrait (Vertical)

Position your recording device so you can monitor the recording. Aim the front of the microphone toward the source, with left and right sides facing the appropriate directions.

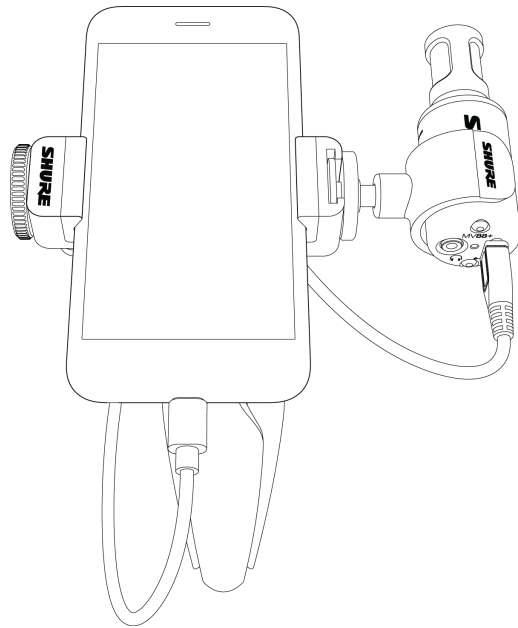

## Landscape (Horizontal) Video Recording

Aim the front of the microphone toward the source. Ensure that the left and right sides of the microphone barrel are facing the appropriate sides.

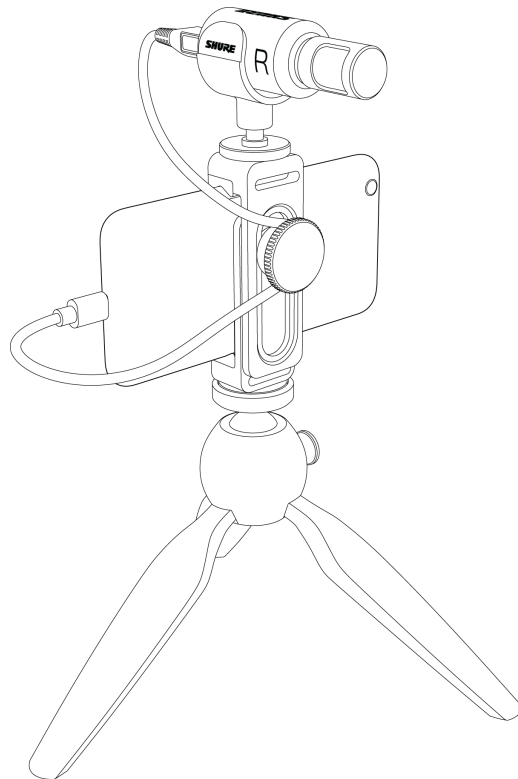

## Portrait/Selfie (Vertical) Video Recording

Aim the microphone toward yourself and select Left - Right Swap.

**Tip:** If you begin shooting in portrait mode, video will remain in portrait mode even if device orientation is turned to landscape.

## Video Interview

- To record audio from on-camera audio only, select the **CARDIOID** polar pattern and point the microphone toward your subject.

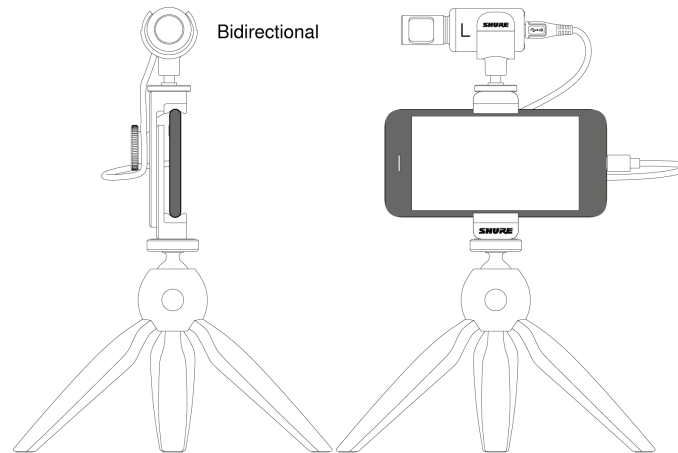

- To capture the voices of both the on-camera subject and the off-camera interviewer, select the **MONO BIDIRECTIONAL** polar pattern in the app. Position the microphone with the left and right sides facing each person.

## Self-Recording (Video Streaming)

Set the device on a flat surface and angle the microphone toward your mouth. Select the **MONO CARDIOID** preset in the MOTIV app to reduce ambient noise.

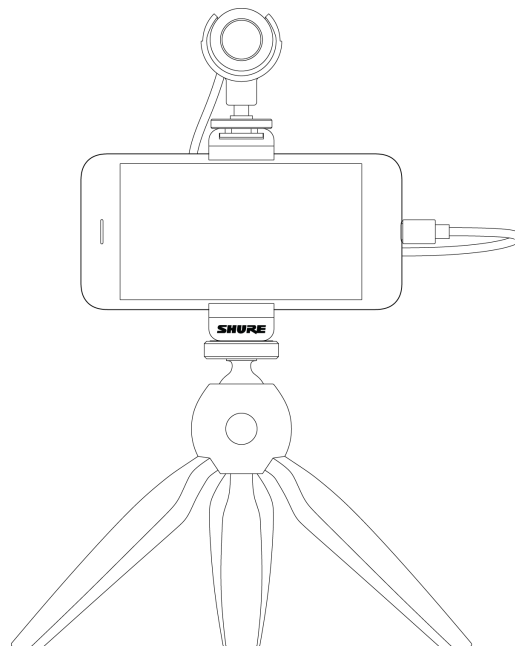

## Handheld Recording

The legs collapse to create a portable hand-held stand.

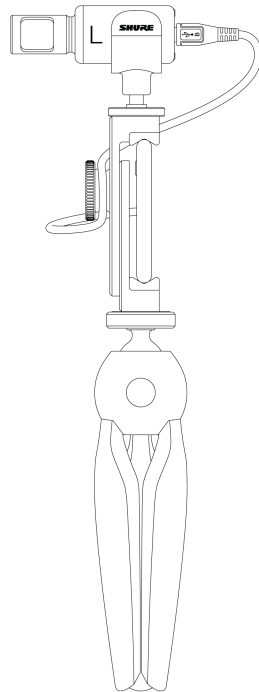

## MV88+ Outputs

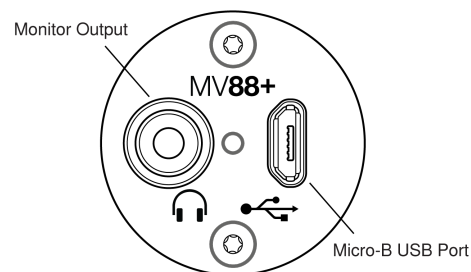

- 3.5mm monitor output for connecting to headphones and earphones
- Send audio to your recording device using the micro-B USB port

## MV88+ LEDs

iOS	Android/Mac/PC
<b>Green: Mic active, audio flowing</b>	<b>Green: Power is on</b>
<b>Amber: Error</b>	
<b>Flash Amber: Firmware is updating</b>	
<b>Red: Microphone is muted</b>	
<b>Flash Red: Audio is clipping</b>	



# Device Setup



Tap Device on the navigation bar to access microphone settings

The screenshot shows the 'Device' settings screen for a Shure MV88+ microphone. The interface is divided into several sections, each with a numbered callout:

- 1:** Top header area showing 'Shure MV88+' and icons for EQ, HPF, headphones, and a lock.
- 2:** Level meters for Left (L) and Right (R) channels, with a dB scale from -48 to 0dB.
- 4:** 'Mic Gain' control set to 33.0 dB with a slider.
- 3:** 'Presets' section with a 'Save' button and a right arrow.
- 5:** 'Instrument' selection icons for voice, guitar, piano, and other instruments.
- 6:** 'Stereo Width' control.
- 7:** A diagram showing the microphone's 60-degree pickup pattern.
- 8:** A large bracket on the right side of the bottom half of the screen, encompassing the Limiter, Compressor, HPF, Left-Right Swap, and Equalizer sections.

Additional settings visible include a 'Limiter' toggle, a 'Compressor' slider with 'OFF', 'LIGHT', 'MEDIUM', and 'HEAVY' options, an 'HPF' (High Pass Filter) slider set to 75Hz, a 'Left - Right Swap' toggle, and an 'Equalizer' section with a waveform icon.

① **Notifications** The top row displays which device is connected. A red flashing dot next to the name let you know whether recording is active. The charms show which advanced features are on. Tap the headphone icon to access direct monitoring control. Tap the lock to lock or unlock the settings.

**Note:** Lock the settings to prevent accidental changes to settings when handling your device during recording. When mic settings are Locked, the setting screen is grayed out.

② **Input Meter** Displays the strength of the input signal and whether that signal is mono or stereo. The loudest peaks should reach within the target range (indicated by the shaded region between -12 and -3 dB).

③ **Microphone Gain** Adjust the mic gain slider to set the volume of the sound source.

④ **Custom Presets** Tap the caret to quickly access your saved presets. Or tap the Save button to save current settings. See Custom Presets for more information.

⑤ **Preset Modes** Set stereo width, equalization, and compression for specific applications. See "Preset Modes" for more information.

⑥ **Polar Pattern Selection** Swipe to choose your pick-up pattern. Use the handles to adjust the width of the stereo image.





**Tip:** Consider the location of the microphone and the size of the sound source when adjusting the width. For example, a large orchestra or ensemble recording benefits from a wide stereo image, which increases separation between instruments. Speech benefits from a narrow width, which improves clarity and rejects ambient (room) sound.

⑦ **Stereo Width Handles** Use the dots to quickly set stereo width.

⑧ **Advanced Features** Fine tune your audio recording with limiter and compressor controls, high pass filter, left-right swap, and equalization settings.

## Preset Modes

Five selectable modes optimize settings for gain, stereo width, equalization, and compression. Set the microphone level and try the modes to find which sounds best. Preset modes can affect the strength of the input signal, so adjust the microphone level as needed after changing presets.

Mode	Application	Characteristics
 <b>Speech</b>	speech	Narrow stereo width to reject background noise, equalization that emphasizes clarity and fullness, and gentle compression.
 <b>Singing</b>	solo or group vocal performances	Medium stereo width with subtle equalization to add richness and clarity for a natural sound.
 <b>Flat</b>	any	An unprocessed signal (no equalization or compression settings used). Adds flexibility when processing the audio after recording.
 <b>Acoustic</b>	acoustic instruments and quiet music	Medium stereo width with transparent compression to smooth out volume spikes and bring out quiet passages. The equalizer setting emphasizes detail and an overall natural sound.
 <b>Loud</b>	live performance and louder sources	Wide stereo to increase separation between sources. Equalization further improves definition by reducing frequencies that can make the instrumentation sound crowded.

## Direct Monitoring Blend

There are two ways to access the Direct Monitoring slider when you want to adjust your monitor source. Tap the input meter to view the mic gain and monitoring blend sliders. Or you can view the slider by tapping the headphone icon in the device settings tab.

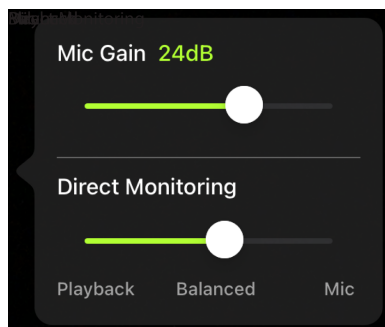

Use the direct monitoring slider to determine how much of each input you hear. For best results, start monitoring at the mid-point and adjust.

- Move the slider towards Mic to hear more of the audio that is being currently recorded by the microphone.
- Move the slider towards Playback when you want to listen to the previously recorded audio and less of the audio coming in to the microphone. This is useful for when you want to review your recording.

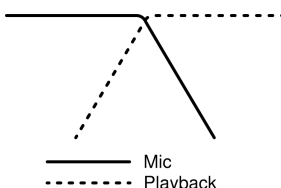

*As one source increases, the other source decreases.*

## Advanced Mic Settings

After you have selected the preset mode for your application, fine tune the sound of your recording with limiter, compressor, and equalizer controls. Your settings will be retained in the microphone when using other audio and video recording applications.

### Limiter

Toggle the limiter on to set an input threshold and prevent distortion from volume peaks in your recordings.

### Compressor

Choose no compression, or select light or heavy compression to control volume when your sound source is dynamic. The compressor will narrow the dynamic range, which means that quiet signals are boosted and loud signals are lowered.

### High Pass Filter

Choose no HPF for the most natural sound. Or select 75 Hz or 150 Hz to reduce wind noise, room noise, or proximity effect.

**75 Hz Low frequency cutoff** Provides a 6 dB-per-octave cutoff at 75 Hz. Helps eliminate floor rumble and low-frequency room noise from heating and air conditioning systems. This setting may also be used to compensate for proximity effect or to reduce low frequencies that make an instrument sound dull or muddy.

**150 Hz Low frequency rolloff** Provides a 6 dB-per-octave rolloff filter at 150 Hz. Use this to compensate for proximity effect or to reduce low frequencies that could make an instrument sound dull or muddy.

## Left-Right Channel Swap



For stereo recordings, use Left - Right Swap to flip the left and right audio channels to match the stereo image to the video. For example, when using video to record yourself.

**Tip:** Use the L and R indicators on the microphone barrel. This way you can set Left - Right Swap before you start to record.

## Equalizer



Change the preset modes to hear the DSP changes, and then use the equalizer to boost or cut bands of frequencies to improve sound clarity.

**Note:** Equalization within presets will not be displayed. However, the equalizer graphic in the advanced settings status bar displays the user-selected equalization.



*Tap to access the MOTIV equalizer. Equalization changes are displayed in the equalizer image.*

EQ persists between preset mode changes.

## Using the Apple Watch with ShurePlus MOTIV

The ShurePlus MOTIV Apple Watch app allows greater recording flexibility when using it as a remote control for the ShurePlus MOTIV Audio and Video Recording Apps.

### Connect your Apple Watch to the MOTIV recording app.

1. Open the Watch App on your iPhone, then tap the My Watch tab
2. Apps that are available to install will appear in the Available Apps section
3. Find the MOTIV Watch app and tap Install

**Note:** See the [Apple support page](#) with additional instructions on Apple watch app installation.

4. The Apple watch will recognize when your MOTIV mic is connected to your phone. The microphone name will be displayed in the upper left corner when the connection is made.

5. Placement of the microphone depends on the size of the room, number of people, and instrument volume. If possible, walk around the room and listen to find where it sounds best.
6. Select the correct preset mode for your recording application. Adjust the microphone level and other settings in the app and place the microphone near your source.

**Note:** Advanced settings should be set up before microphone is in place. The Apple Watch app will only allow you to control record, pause recording, complete recording, make bookmarks and set and lock gain control.

## Controls and Navigation

**Start recording:** Tap the red record button

**Pause recording:** Tap the pause icon. You can continue recording from a paused state

**Create bookmark:** Tap the bookmark icon

**Stop recording:** Tap the Done button

**Adjust gain:** Use the digital crown on the Apple Watch

**Lock mic gain:** Tap the lock icon

---

## Recording Tips

### Turn Off Notifications

When you open the MOTIV app, a message prompts you to enable airplane mode and do not disturb mode. It's important to do this to avoid recording interference from phone calls, messages, and various notifications which can add static to your recordings.

**Note:** Enable airplane mode and then turn Wi-Fi back on to add geolocation information to your audio file.

### Adjust your Sample Rate

Select a lower sample rate when it is useful to have a smaller file, for example, when recording speech or a podcast for download. Select a higher sample rate for music and dynamic recordings.

### Get the Best-looking Video Image

Pinch to zoom in or out and frame your shot. Swipe up and down to set brightness. Tap to focus or tap and hold to lock brightness and focus. Tap again to release the lock.

### Record in Mono

Record in mono to increase your available record time or when recording a single source, like vocals, that would benefit from less ambient noise. Select the Mono Cardioid or Mono Bidirectional polar pattern and audio from all capsules are summed to a single channel. The input meter will indicate mono recording by displaying the top half of the waveform. MOTIV supports third-party microphones with mono recording.

### Record in Stereo

Rotate the MV88+ barrel in the mic clip to accommodate portrait or landscape recording. L and R are labeled to show stereo orientation of the microphone. The stereo image is accurate if the Shure logo is facing upward.

### Capture the Complete Performance

To ensure that you capture the entire sound source, start your recording before the performance starts and edit the recording later to trim any silence.

**Note:** If your microphone accidentally becomes disconnected during recording, MOTIV will automatically stop the recording. The save file dialog will appear, prompting you to name and save your audio.

## Record with Confidence with Automatic Save

If your microphone accidentally becomes disconnected during recording, MOTIV will automatically stop the recording. The save file dialog will appear, prompting you to name and save your audio.

## Sharing MOTIV Video Recordings

Stop the recording to create a video file that is saved in the Photos app on your mobile device. You can share videos created with the MOTIV video recording app from Photos.

- On an iOS device, find your video in Photos > MOTIV. Or in Photos > Media Types > Videos.
- On an Android device, find your video in the main Photos library or in Photos > Albums > Camera.

## Troubleshooting

Issue	Solution
<b>Microphone is plugged in, but the volume meter does not register a signal.</b>	Edit the privacy setting for your recording device under SETTINGS > PRIVACY > MICROPHONE to give the app permission to use the microphone.
<b>Microphone is plugged in, but not detected.</b>	Unplug and reconnect the cable connections so that the app recognizes the microphone. You'll know that the connection is secure when you see the microphone name visible in the status bar.
<b>You hear no audio despite LEDs and the volume meter responding as if audio is present.</b>	Check the Monitor Mix blend to ensure that audio is passing and you can monitor playback. Move the Monitor Mix slider to the center to hear audio that is being currently recorded and previously recorded audio.
<b>Audio sounds bad or distant.</b>	To ensure that you are receiving audio from the MOTIV microphone and not a built-in microphone; unplug and reconnect the microphone. You'll know that the connection is secure when you see the microphone name visible in the status bar.
<b>Audio is distorted.</b>	Use the audio meter to ensure that volume peaks are within the target range (the gray area). If the level reaches the red peak indicator of the input meter, turn the gain down.
<b>Left/right stereo channels do not match video.</b>	Depending on the orientation of the recording device, it may be necessary to engage the Left-Right swap in MOTIV settings. If the audio has already been recorded, you can switch the left and right channels in most audio editing software.
<b>Audio is not in sync with video</b>	Switch to a lower frame rate or resolution size. You might achieve better performance with a less system intensive frame rate.
<b>Unable to share file.</b>	If a file is too large to be shared, there are a couple options for reducing file size.  Convert your file to a compressed file format.

Issue	Solution
	<p>Connect your mobile device to your computer and use file transfer, like iTunes, to download the file to your desktop.</p> <p>Split your track in two, export both files and recombine them using audio editing software.</p>
<b>General troubleshooting.</b>	<p>Ensure that your app is updated to the most current version.</p> <p>Make sure that your phone's operating system is updated to the most current version.</p> <p>Check to see how the microphone works using a different connection cable or different device.</p> <p>Close and restart the application.</p> <p>Powering down and rebooting the device will clear the cache and can sometimes help with software performance.</p>

**Note:** It may be useful to reset the app to restore functionality. Perform a hard reset by unplugging and re-plugging the microphone.

## System Requirements

### System Requirements and Compatibility: iOS

- **iOS:** iOS 12 and higher
- **iPhone:** iPhone 6 and higher
- **iPod Touch:** 6th gen

**Note:** iPad Pro (USB-C) is not supported.

### System Requirements and Compatibility: Android

Will work with any Android device that has:

- Android Oreo 8.0 and higher
- USB Host Power Requirement of  $\geq 100$  mA
- USB Audio Class 1.1 support and higher

Android is a trademark of Google Inc.

**Note:** See <https://www.shure.com/MOTIVcompatibility> for information on supportive Android devices.

## Specifications

### MFi Certified

Yes

### DSP Modes (Presets)

Speech/Singing/Acoustic/Loud/Flat

## Polar Pattern

Adjustable Width Stereo/Mono Bidirectional/Mono Cardioid/Mid-Side

## Stereo Principle

Mid-Side

## Supported Audio Format

*iOS*

WAV, AAC (Up to 256 KHz)

## Supported Audio Format

*Android*

AAC (Up to 256 KHz)

## Frequency Response

20 Hz to 20,000 Hz

## Adjustable Gain Range

0 to +36 dB

## Sensitivity

-37 dBFS/Pa at 1 kHz [1] [2]

## Maximum SPL

120 dB SPL [2]

## Limiter

Yes

## Compressor

Yes

## Equalizer

5-band

[1] 1 Pa=94 dB SPL

[2]At Minimum Gain, Flat Mode

Bit Depth	Sampling Rate
24	48 kHz
24	44.1 kHz
16	48 kHz
16	44.1 kHz



## Supported Audio Formats

### Android

<b>PCM/WAV</b>	Up to 352 KHz
<b>AAC</b>	256, 128, 96

### iOS

<b>PCM/WAV</b>	Up to 352 KHz
<b>MP4 Audio</b>	Audio file extensions: .mp4, .m4a, .m4p, .m4b
<b>AAC</b>	256, 128, 96

## Certifications

**Industry Canada ICES-003 Compliance Label:** CAN ICES-3 (B)/NMB-3(B)

**Note:** Testing is based on the use of supplied and recommended cable types. The use of other than shielded (screened) cable types may degrade EMC performance.

This product meets the Essential Requirements of all relevant European directives and is eligible for CE marking.

The CE Declaration of Conformity can be obtained from: [www.shure.com/europe/compliance](http://www.shure.com/europe/compliance)

Authorized European representative:

Shure Europe GmbH

Global Compliance

Jakob-Dieffenbacher-Str. 12

75031 Eppingen, Germany

Phone: +49-7262-92 49 0

Email: [info@shure.de](mailto:info@shure.de)

[www.shure.com](http://www.shure.com)



Made for iPhone Xs Max, iPhone Xs, iPhone XR, iPhone X, iPhone 8 Plus, iPhone 8, iPhone 7 Plus, iPhone 7, iPhone SE, iPhone 6s Plus, iPhone 6s, iPhone 6 Plus, iPhone 6, iPhone 5s, iPhone 5c, iPhone 5, iPad Pro (10.5-inch), iPad Pro (12.9-inch) 2nd generation, iPad Pro (12.9-inch) 1st generation, iPad Pro (9.7-inch), iPad mini 4, iPad mini 3, iPad mini 2, iPad Air 2, iPad Air, iPad (6th generation), iPad (5th generation), iPad (4th generation), iPod touch.

iPad, iPhone, iPod, and iPod touch are trademarks of Apple Inc., registered in the U.S. and other countries. iPad Air, iPad mini, and Lightning are trademarks of Apple Inc. The trademark "iPhone" is used in Japan with a license from Aiphone K.K.

PIXI® and Manfrotto® are registered trademarks of Vitec Imaging Solutions. Mini tripod maximum weight: 1Kg/2.2 lbs.