

24W POWER SUPPLY

The E2 family of AC/DC switch mode power supplies offers an unmatched degree of flexibility. A variety of housings and customization options allow the same reliable electronic core to be used in a wide range of applications.

Features

- Ultra-low standby losses
- High Efficiency
- Protection class II
- Wide selection of output plugs
- Premium quality Japanese brand capacitors
- Manufacturing according to ISO 9001
- Short circuit proof
- Designed in Austria
- Made in the Czech Republic



Options

- Power on LED
- Customer specific connectors and housing



Specification		
Output Power	24	W
Output Voltage	5 - 24	V
Output current	3	A
Universal input voltage	90 - 264	V
Operating temperature	0 - 40	°C
Efficiency	typ. 86,6	%
Standby Power	typ. 35	mW
Efficiency level	VI	
Means of protection	2 x MOPP	
Insulation of output	SELV	
Leakage current	max. 100	µA

Housing versions			
Wall plug-in, fixed or interchangeable			
EU	UK	US	AUS

Approvals			

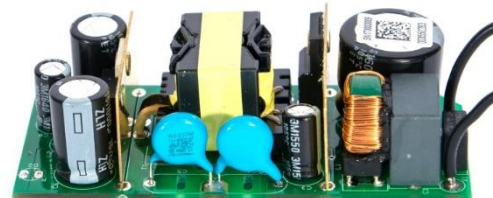
Test standards	
EN 55014-1 EN 55014-2 EN 55032 EN 55024 EN 60601-1-2	General EMC standards
EN 60950-1 UL 60950-1 EN 62368-1 UL 62368-1	Information technology equipment
EN 60335-1 EN 61558-2-16 EN 61558-1	Household devices
EN 60601-1 EN 60601-1-11 ES 60601-1	Medical electrical equipment
EN60601-1-11 Degree of protection: IP22	Home healthcare environment Only for housing types: E, U, G

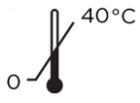

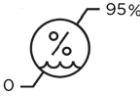
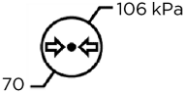
Parameter	Symbol	Min	Typ.	Max	Unit	Test Cond.
Specifications are subject to change without any notice.						
Input Voltage	U_{IN}	90		264	V_{AC}	
	Operation above the specified maximum input voltage may cause damage. Below the minimum input voltage the unit does not meet the specification.					
Input Current	I_{IN}	9	300	800	mA	
Input Frequency	f_{IN}	47	50	63	Hz	
Efficiency	η		86,6		%	at full load
Stand-by power	P_{stb}		35	75	mW	without load
International efficiency mark		VI				
Output Power	P_{out}			24	W	
Output Voltage	U_{out}	5		24	V_{DC}	
Output voltage tolerance	$\Delta U_{out PCB}$			3	%	at PCB
Output voltage tolerance at end of standard cable	$\Delta U_{out cable}$			+3/-5	%	12-24V U_{out} 1,5m/0,5mm ²
Ripple Voltage	$U_{r rms}$			50	mV _{rms}	
Output Current	I_{out}			3	A	
Max. Overload current	$I_{out\ overload}$		140		% of I_{out}	$U_{IN} = 264V$ $U_{IN} = 90V$
			130			
Maximum 1 minute overload duration, followed by 15 minute cooldown period.						
Isolation	Galvanic isolation with safety extra low voltage (SELV) output					
Means of protection	2 x MOPP					
Dielectric Strength	Standard	3			kV_{AC}	50Hz sinusoidal waveform
	Household	3,9				
	Medical	4,4				
Leakage current	I_{LK}			100	μA	
Operating Temperature	 T_{OP}	0		40	$^{\circ}C$	free convection
Storage Temperature		 T_{ST}	-30	25	80	$^{\circ}C$
Humidity					95	%
Atmospheric Pressure			70		106	kPa
Single component failure	A single component failure does not cause any damage to persons or ambient (fire, explosions, etc).					
Disconnecting device	Direct plug-in	The power supply itself is the disconnecting device. Socket-outlet shall be easily accessible.				

Ordering information and part number example									
E2	C	F	M	W	3	L	24	12V	2,5A
	Housing E Euro plug U US, Canada plug G United Kingdom plug C Interchangeable plug		Application S Information Technology H Household M Medical		Tolerance 3 3% 1 1% on PCB	Options L Power On LED		Voltage 5 - 24V Fixed voltage set at factory	Current 0 - 3A 24W/U _{out} max.
For versions with output cable please also specify the plug and cable length. Please refer to the document "secondary plug overview" for our range of standard cables, or specify a customer specific connector as required.									

Reliability		
MTBF	22,2 years	at 50°C ambient
MTBF calculation according to standards	MIL-HDBK-217 F; - Notice 1; - Notice 2	
Maintainability	The power supply is not to be repaired	



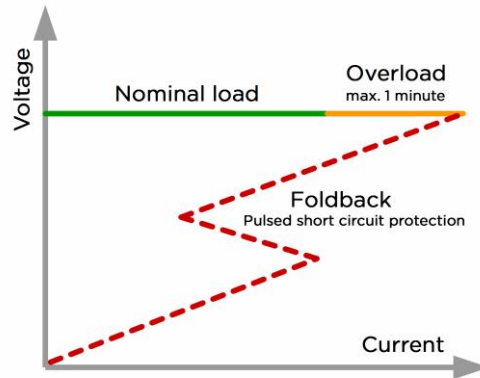



Output template











The power supply is protected against short circuit.
A shorted output does not cause any damage, and normal operation will resume once the short is removed.

Laser marking

Marking plate symbol explanation

Product name Input parameters Output parameters Safety instructions Date code of production CE marking Approval marks		Conformity with the relevant EU directives.
		ENEC is the high quality European Mark for electrical products that demonstrates compliance with European standards (EN).
		NRTL Canada / USA Mark issued by Curtis Straus.
	RoHS conform 	The power supply has to be disposed appropriately according the local regulations for Waste Electrical and Electronic Equipment.
		For indoor use only.
		Read instruction manual.

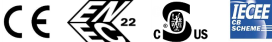
Certification overview

Housing	Information Technology	Household	Medical
EU, UK			
US, Canada			
Interchangeable Plug			

Euro Housing

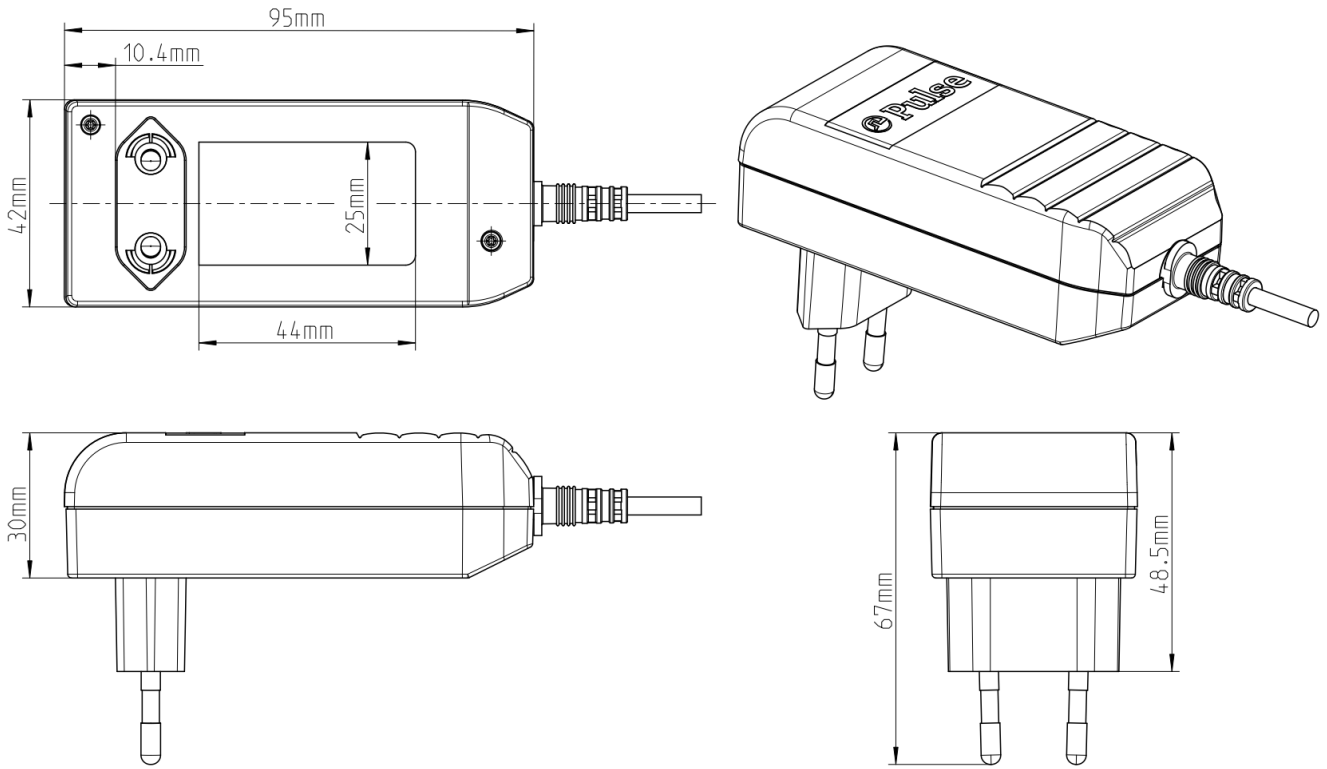

US Housing

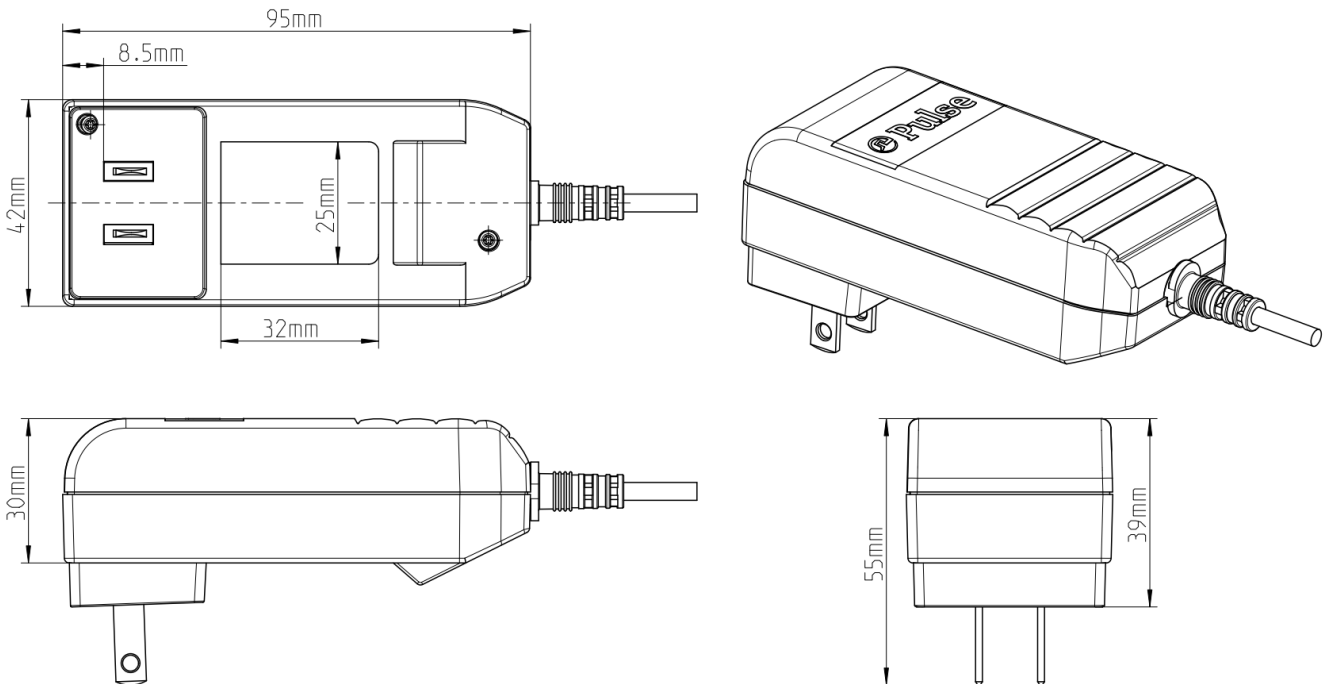

E2xFyW3 24 LV6

UK Housing

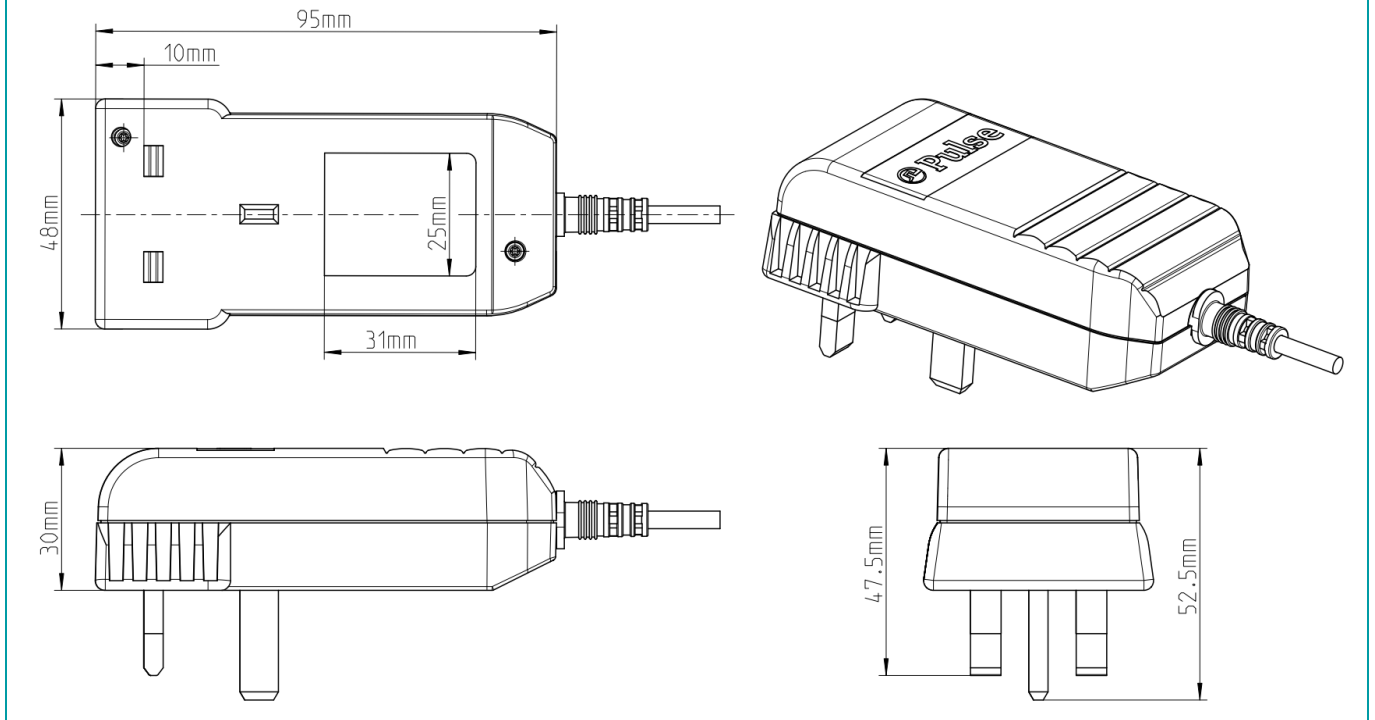

Interchangeable Plug Housing

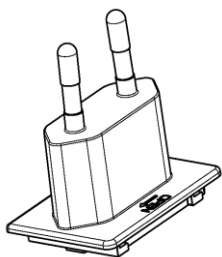
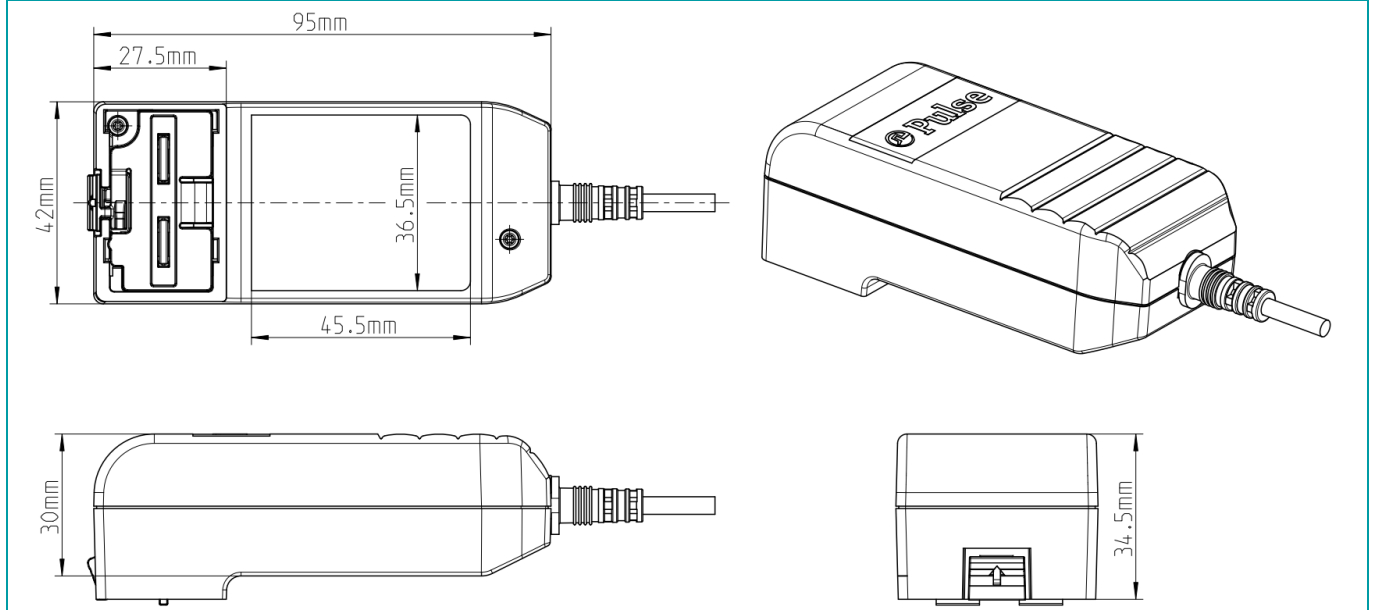

EU Plug
 according EN50075

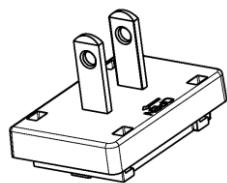

US Plug
 according UL1310

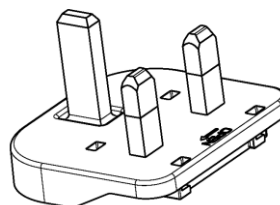

UK Plug
 according BS1363

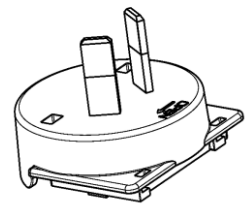

Australia Plug
 acc. AS/NZS 3112

Packaging and weight			
E2EFSW3 24 LV6			
Single Carton	pcs	kg	size (mm)
	1	0,16	125x67x44
Power Supply per Packaging Case	50	8	371x266x242
Power Supply per Layer (EU- Pallet) 9 Packaging cases	450	93	1200x800x242
1 Full Pallet (6 Layer)	2700	453	1200x800x1500
E2GFSW3 24 LV6			
Single Carton	pcs	kg	size (mm)
	1	0,18	135x74x49
Power Supply per Packaging Case	50	9	406x286x272
Power Supply per Layer (EU- Pallet) 8 Packaging cases	400	93	1200x800x272
1 Full Pallet (5 Layer)	2000	360	1200x800x1500
E2UFSW3 24 LV6			
Single Carton	pcs	kg	size (mm)
	1	0,16	125x67x44
Power Supply per Packaging Case	50	8	371x266x242
Power Supply per Layer (EU- Pallet) 9 Packaging cases	450	93	1200x800x242
1 Full Pallet (6 Layer)	2700	453	1200x800x1500
E2CFSW3 30 LV6			
Single Carton (including Power Supply and 4 Adapters)	pcs	kg	size (mm)
	1	0,24	210x74x50
Power Supply per Packaging Case	25	6	406x286x272
Power Supply per Layer (EU- Pallet) 8 Packaging cases	200	69	1200x800x272
1 Full Pallet (5 Layer)	1000	261	1200x800x1500

EMC – Special requirements according medical standard (Only for medical devices)	
Intended use and intended environment	Home healthcare and/or Professional environment
Basic safety and essential performance of the EUT	The power supply unit is not a medical end product, therefore no essential performance is defined by the manufacturer.
Basic safety regarding EMC	The power supply has to ensure proper output voltage according to its characteristics, without service within expected service life.
WARNINGS	Medical electrical equipment needs special precautions regarding EMC and needs to be installed according to EMC information.
	PE of power supply shall be connected to PE of end medical product. User shall not modify power supply.
	The switch mode power supply is designed to achieve the EMI behavior of the specified environment, it includes specific EMI filter to reduce the emissions which are specified in the IEC60601-1-2 standard.
	Please read the complete technical documentation to avoid adverse events to the patient and operator. Read also instructions for use.

EMC - Environment			
The power supply is intended for use in the electromagnetic environment specified below. The customer or the user of the power supply should assure that it is used in such an environment.			
Emissions test	Compliance	Electromagnetic environment - guidance	
RF emissions CISPR 11	Group 1	The power supply uses RF energy only for its internal function. Therefore, its RF emissions are very low and are not likely to cause any interference in nearby electronic equipment.	
RF emissions CISPR 11	Class B	The power supply is suitable for use in all establishments, including domestic establishments and those directly connected to the public low-voltage power supply network that supplies buildings used for domestic purposes.	
Harmonic emissions IEC 61000-3-2	Complies		
Voltage fluctuations / flicker emissions IEC 61000-3-3	Complies		
Immunity test	EN 60601-1-2:2015 test level	Achieved levels according EN 60601-1-2:2015 and achieved levels from additional standards.	Electromagnetic environment - guidance
Electrostatic discharge (ESD) IEC 61000-4-2	± 8 kV contact ±2 kV, ± 4 kV, ± 8 kV, ± 15 kVair	± 8 kV contact ±2 kV, ± 4 kV, ± 8 kV, ± 15 kVair	Floors should be wood, concrete or ceramic tile. If floors are covered with synthetic material, the relative humidity should be at least 30%.
Electrical fast transient/burst IEC 61000-4-4	± 2 kV 100 kHz repetition frequency	± 2 kV (mains input), 100 kHz ± 2 kV (DC output), 5 kHz	Mains power quality should be that of a typical commercial or hospital environment.
Surge IEC 61000-4-5	Line-Line: ± 0,5 kV, ± 1 kV Line-to-ground: ± 0,5 kV, ± 1 kV, ± 2 kV	±1 kV symmetrical – Differential mode (AC), ±2 kV symmetrical – Common mode (AC), ±0.5 kV symmetrical –	Mains power quality should be that of a typical commercial or hospital environment.

		Differential mode (DC), ±0.5 kV symmetrical – Common mode (DC), 1.2/50 us Open Circuit Voltage	
Voltage dips, short interruptions and voltage variations on power supply input lines IEC 61000-4-11	0 % Ut; 0,5 cycle At 0°, 45°, 90°, 135°, 180°, 225°, 270° and 315°	0 % Ut; 0,5 cycle At 0°, 45°, 90°, 135°, 180°, 225°, 270° and 315°	Mains power quality should be that of a typical commercial or hospital environment. If the user of the power supply requires continued operation during power mains interruptions, it is recommended that the power supply is powered from an uninterruptible power supply or battery.
	0 % Ut; 1 cycle and 70 % Ut; 25/30 cycles Single phase: at 0°	0 % Ut; 1 cycle and 70 % Ut; 25/30 cycles Single phase: at 0°	
	0 % Ut; 250/300 cycle	0 % Ut; 250/300 cycle	
Power frequency (50/60 Hz) magnetic field IEC 61000-4-8	30 A/m	1, 3, 30 A/m	Power should be at levels characteristic of frequency magnetic fields a typical location in a typical commercial or hospital environment.
Conducted RF IEC 61000-4-6	6 Vrms 150 kHz to 80 MHz	6 Vrms	Portable and mobile RF communications equipment should not be used closer to any part of the power supply, including cables, than the recommended separation distance.
Radiated RF IEC 61000-4-3	10 V/m 80 MHz to 2.7 GHz	10 V/m	Recommended separation distances see following table.

Field strengths from fixed transmitters such as base stations for radio (cellular/cordless) telephones, land mobile radios, amateur radio, AM and FM radio broadcast and TV broadcast, cannot be predicted theoretically with accuracy. To assess the electromagnetic environment due to fixed RF transmitters an electromagnetic site survey should be considered. If the measured field strength in the location in which the power supply is used, exceeds the applicable RF compliance level above, the power supply should be observed to verify normal operation. If abnormal performance is observed, additional measures may be necessary, such as reorienting or relocating the power supply.

Field strengths from fixed RF transmitters, as determined by an electromagnetic site survey should be less than the compliance level in each frequency range. Over the frequency range 150 kHz to 80 MHz, field strength should be less than 3 V/m.



Interference may occur in the vicinity of equipment marked with the following symbol:

Proximity fields from RF wireless communications equipment IEC 61000-4-3	Frequency range and Level: RF wireless communication equipment			Supplementary information:
	Test Frequency (MHz)	Modulation	Immunity Level (V/m)	
	385	**Pulse Modulation: 18Hz	27	EUT powered at one of the nominal input voltages and frequencies. Dwell time minimum 1s. Actual dwell time noted in results table. Note * - As an alternative to FM modulation, 50% pulse modulation at 18Hz may be used because while it does not represent actual modulation, it would be worst case. Note ** - The carrier shall be modulated using 50% duty cycle square wave signal.
	450	*FM ±5Hz deviation: 1kHz sine	28	
	710 745 780	**Pulse Modulation: 217Hz	9	
	810 870 930	**Pulse Modulation: 18Hz	28	
	1720 1845 1970	**Pulse Modulation: 217Hz	28	
	2450	**Pulse Modulation: 217Hz	28	
	5240 5500 5785	**Pulse Modulation: 217Hz	9	

Recommended separation distances between portable and mobile RF communications equipment and the power supply

The power supply is intended for use in the electromagnetic environment in which radiated RF disturbances are controlled. The customer or the user of the power supply can help prevent electromagnetic interference by maintaining a minimum distance between portable and mobile RF communications equipment (transmitters) and the power supply as recommended below, according to the maximum output power of the communication equipment.

Rated maximum output power of transmitter (W)	Separation distance according to frequency of transmitter (m)		
	150 kHz to 80 MHz $d = 1.2\sqrt{P}$	80 MHz to 800 MHz $d = 1.2\sqrt{P}$	800 MHz to 2.5 GHz $d = 2.3\sqrt{P}$
0.01	0.12	0.12	0.23
0.1	0.38	0.38	0.73
1	1.2	1.2	2.3
10	3.8	3.8	7.3
100	12	12	23

For transmitters rated at a maximum output power not listed above, the recommended separation distance d in metres (m) can be determined using the equation applicable to the frequency of the transmitter, where P is the maximum output power rating of the transmitter in watts (W) according to the transmitter manufacturer.

- NOTE 1 At 80 MHz and 800 MHz, the separation distance for the higher frequency range applies.
 NOTE 4 These guidelines may not apply in all situations. Electromagnetic propagation is affected by absorption and reflection from structures, objects and people.

Energy Efficiency

This power supply family fulfills Directive 2009/125/EC with Commission Regulation (EU) 2019/1782. The vales “Average active efficiency”, “Efficiency at low load” and “No-load power consumption” are typical measured values, measured at one representative sample at an input voltage of 230VAC.

Input specification		
Input Voltage	100-240	VAC
Input Frequency	50-60	Hz

Output specification						
Output voltage	5	9	12	15	24	VDC
Output current	3	2,67	2	1,6	1	A
Output power	15	24	24	24	24	W
Average active efficiency (100%/75%/50%/25%)	82,39	86,75	87,90	87,45	88,46	%
Efficiency at low load (10 %)	80,28	83,63	82,98	83,30	81,48	%
No-load power consumption	22	32	33	36	49	mW

Revision	Date	Author	Change
A	01.09.2016	Krimmel	First edition
B	08.03.2017	Mauritz	Disconnecting Device added
C	07.08.2017	Mauritz	HV testing voltage changed
D	08.08.2017	Mauritz	Reliability, EMC added, Approval and test standards
E	19.12.2017	Mauritz	MTBF added
F	30.03.2018	Krimmel	Update to new document design
G	06.03.2019	Mauritz	ENEC at medical devices removed
H	21.03.2019	Mauritz	Disconnecting device changed
I	27.08.2019	Mauritz	Test standards changed
J	04.02.2020	Mauritz	Energy Efficiency added
K	14.04.2020	Mauritz	Parameter Symbols added, Test standards changed
L	17.11.2020	Mauritz	Trademark Pulse added

CONFIDENTIAL

This document contains proprietary information originated and/or owned by EGSTON System Electronics Eggenburg GmbH. This information shall not be duplicated, used or disclosed in whole, or in part, to any other party or used for any other purpose without the prior consent of EGSTON System Electronics Eggenburg GmbH.

Copyright © 2020 EGSTON System Electronics Eggenburg GmbH, A-3730 Eggenburg, Grafenberger Straße 37
All Rights Reserved.