

WP1.2-6 6V 1.2Ah

Specifications

Nominal Voltage(V) **6V**

Nominal Capacity

20 hour rate	(0.06A to 5.25V)	1.2Ah
10 hour rate	(0.114A to 5.25V)	1.14Ah
5 hour rate	(0.204A to 5.1V)	1.02Ah
1 C	(1.2A to 4.8V)	0.68Ah
3 C	(3.6A to 4.8V)	0.48Ah

Weight **Approx. 297g(0.65Lbs.)**

Internal Resistance (at 1KHz) **Approx. 41 mΩ**

Maximum Discharge Current for 5 seconds: **18A**

Charging Methods at 25 (77)

Cycle use:	
Charging Voltage	7.20 to 7.50V
Coefficient -5.0mV/ /cell	
Maximum Charging Current :	0.36A
Standby use:	
Float Charging Voltage	6.75 to 6.90V
Coefficient -3.0mV/ /cell	

Operating Temperature Range

Charge	-15 (5) to 40 (104)
Discharge	-15 (5) to 50 (122)
Storage	-15 (5) to 40 (104)

Charge Retention (shelf life) at 20 (68)

1 month	92%
3 month	90%
6 month	80%

Case Material **ABS UL94 HB**
Option: Flammability resistance of (UL94 V-0)

Terminal **F1 or F2 (Faston Tab 187 or 250)**



Dimensions

mm(inch)

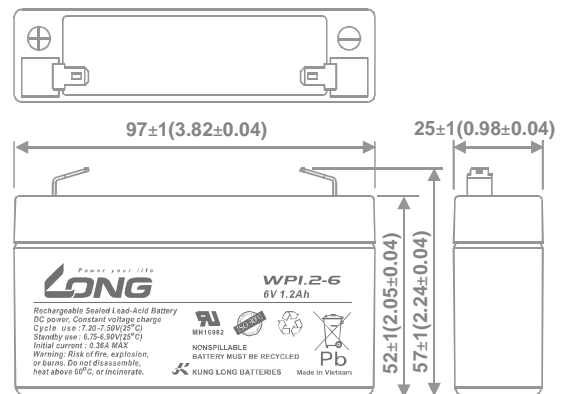
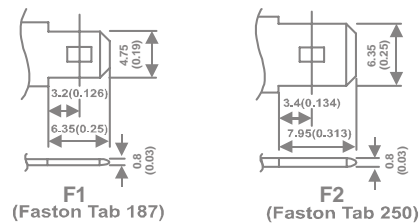

(V) FOR 6V BATTERY Discharge Time VS. Discharge Current (25)

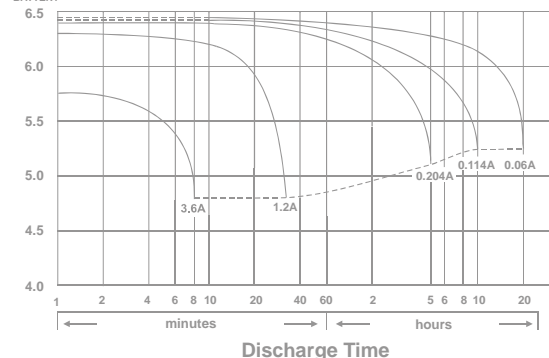

Effect of Temperature on Capacity 25 (77)

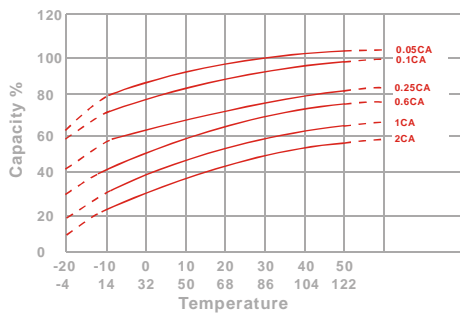

Capacity Retention Characteristic

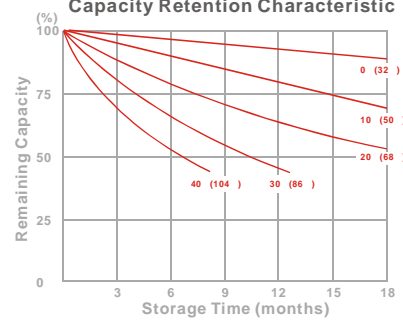

Trickle (or float) Service Life

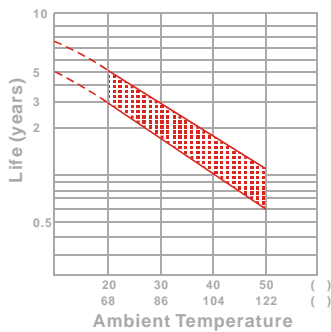

Cycle Service Life

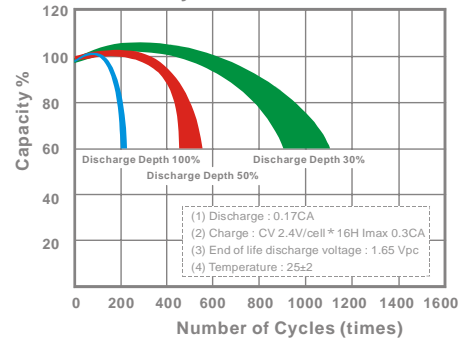

- PERFORMANCE DATA

Discharge Rates in Watts to Various End Voltages at 25 (77)

End Voltage		1.85V	1.80V	1.75V	1.70V	1.67V	1.65V	1.60V
Time								
5	min	7.18	7.82	8.27	8.65	8.80	8.98	9.28
10	min	4.62	5.00	5.30	5.52	5.58	5.67	5.77
15	min	3.65	3.87	4.05	4.20	4.25	4.32	4.38
30	min	2.15	2.25	2.32	2.37	2.38	2.42	2.45
60	min	1.32	1.39	1.43	1.47	1.48	1.50	1.52
120	min	0.747	0.808	0.847	0.875	0.887	0.900	0.915
180	min	0.533	0.573	0.602	0.623	0.633	0.645	0.657
240	min	0.435	0.470	0.495	0.513	0.520	0.528	0.537
300	min	0.420	0.442	0.457	0.468	0.472	0.477	0.482
600	min	0.220	0.233	0.243	0.250	0.252	0.255	0.258
1200	min	0.123	0.126	0.129	0.130	0.131	0.131	0.132

- Discharge Rates in Amperes to Various End Voltages at 25 (77)

End Voltage		1.85V	1.80V	1.75V	1.70V	1.67V	1.65V	1.60V
Time								
5	min	3.49	4.11	4.57	4.94	5.09	5.26	5.51
10	min	2.12	2.43	2.63	2.81	2.88	2.96	3.11
15	min	1.71	1.95	2.09	2.20	2.24	2.29	2.35
30	min	0.931	1.06	1.17	1.24	1.26	1.29	1.32
60	min	0.680	0.716	0.735	0.759	0.765	0.772	0.779
120	min	0.392	0.415	0.429	0.440	0.444	0.449	0.456
180	min	0.272	0.291	0.302	0.311	0.314	0.318	0.324
240	min	0.223	0.238	0.247	0.254	0.257	0.260	0.264
300	min	0.207	0.219	0.226	0.231	0.233	0.236	0.238
600	min	0.112	0.117	0.121	0.124	0.125	0.126	0.127
1200	min	0.0615	0.0624	0.0631	0.0637	0.0639	0.0642	0.0646

All data on the spec. sheet is an average value:

The tolerance range : X<6min(+15%~-15%), 6min X<10min(+12%~-12%),10min X < 60min(+8%~-8%), X 60min(+5%~-5%)

211016-1F



Head Quarter Service - TEL: +886-49-2254-777 FAX: +886-49-2255-139 E-mail: sales@mail.klb.com.tw
 USA Customer Service - TEL: +1-949-328-7936 FAX: +1-949-266-9917 E-mail: sales@kunglong.com
 Vietnam Customer Service - TEL: +84-72-3779666 FAX: +84-72-3779476 E-mail: sales@mail.klb.com.tw