

Circutor

Expansion modules for the line-CVM and
line-EDS devices

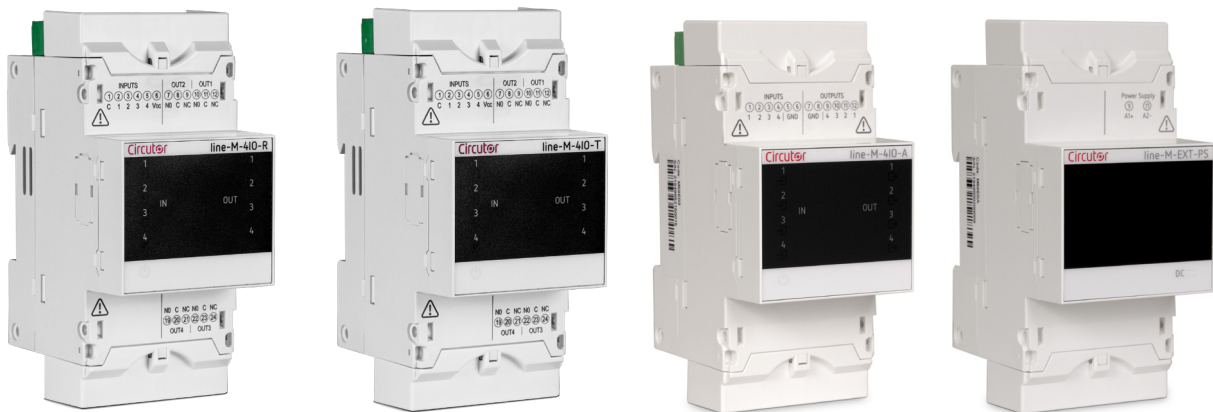

INSTRUCTION MANUAL

(M239B01-03-21A)



SAFETY PRECAUTIONS

Follow the warnings described in this manual with the symbols shown below.

	<p>DANGER Warns of a risk, which could result in personal injury or material damage.</p>
---	---

	<p>ATTENTION Indicates that special attention should be paid to a specific point.</p>
---	--

If you must handle the unit for its installation, start-up or maintenance, the following should be taken into consideration:

	<p>Incorrect handling or installation of the unit may result in injury to personnel as well as damage to the unit. In particular, handling with voltages applied may result in electric shock, which may cause death or serious injury to personnel. Defective installation or maintenance may also lead to the risk of fire.</p> <p>Read the manual carefully prior to connecting the unit. Follow all installation and maintenance instructions throughout the unit's working life. Pay special attention to the installation standards of the National Electrical Code.</p>
---	--

	<p>Refer to the instruction manual before using the unit</p> <p>In this manual, if the instructions marked with this symbol are not respected or carried out correctly, it can result in injury or damage to the unit and /or installations.</p>
---	---

CIRCUTOR, SA reserves the right to modify features or the product manual without prior notification.

DISCLAIMER

CIRCUTOR, SA reserves the right to make modifications to the device or the unit specifications set out in this instruction manual without prior notice.

CIRCUTOR, SA on its web site, supplies its customers with the latest versions of the device specifications and the most updated manuals.

www.circutor.com



	<p>CIRCUTOR, recommends using the original cables and accessories that are supplied with the device.</p>
---	---

CONTENTS

SAFETY PRECAUTIONS	3
DISCLAIMER	3
CONTENTS.....	4
REVISION LOG	7
SYMBOLS.....	7
1 - VERIFICATION UPON RECEPTION	8
2 - PRODUCT DESCRIPTION	8
3.- INSTALLATION OF THE DEVICE	10
3.1.- PRELIMINARY RECOMMENDATIONS	10
3.2.- INSTALLATION	11
3.3.- PANEL ADAPTER 72 x 72 mm.....	12
4.- LINE-M-4IO-R.....	14
4.1.- DEVICE TERMINALS	14
4.2.- CONNECTION DIAGRAM	15
4.3.- LED INDICATORS.....	16
4.4.- CONFIGURATION line-M-4IO-R	17
4.4.1.- CONFIGURATION OF DIGITAL INPUTS 1 ... 4	18
4.4.2.- CONFIGURATION OF RELAY OUTPUTS 1 ... 4.....	20
4.5.- MODBUS MEMORY MAP line-M-4IO-R.....	29
4.5.1.- INPUT AND OUTPUT STATUS	29
4.5.2.- PULSE METERS	29
4.5.3.- ALARMS	30
4.5.4.- DEVICE CONFIGURATION VARIABLES	30
4.6.- TECHNICAL FEATURES: line-M-4IO-R.....	36
5.- LINE-M-4IO-T	38
5.1.- DEVICE TERMINALS	38
5.2.- CONNECTION DIAGRAM	39
5.3.- LED INDICATORS.....	40
5.4.- CONFIGURATION line-M-4IO-T	41
5.4.1.- CONFIGURATION OF DIGITAL INPUTS 1 ... 4	42
5.4.2.- CONFIGURATION OF TRANSISTOR OUTPUTS 1 ... 4	42
5.5.- MODBUS MEMORY MAP line-M-4IO-T	42
5.5.1.- INPUT AND OUTPUT STATUS	42
5.5.2.- PULSE METERS	42
5.5.3.- ALARMS	42
5.5.4.- DEVICE CONFIGURATION VARIABLES	42
5.6.- TECHNICAL FEATURES: line-M-4IO-T	43
6.- LINE-M-4IO-A.....	44
6.1.- DEVICE TERMINALS	44
6.2.- CONNECTION DIAGRAM	45
6.3.- LED INDICATORS.....	45
6.4.- CONFIGURATION Line-M-4IO-A	47
6.4.1.- CONFIGURATION OF ANALOGUE INPUTS 1 ... 4.....	48
6.4.2.- CONFIGURATION OF ANALOGUE OUTPUTS 1 ... 4.....	50
6.5.- MODBUS MEMORY MAP line-M-4IO-A	51
6.5.1.- ANALOGUE INPUT.....	51
6.5.2.- DEVICE CONFIGURATION VARIABLES	51
6.6.- TECHNICAL FEATURES: line-M-4IO-A.....	55
7.- LINE-M-4IO-RV	57
7.1.- DEVICE TERMINALS.....	57
7.2.- CONNECTION DIAGRAM.....	58
7.3.- LED INDICATORS.....	59
7.4.- CONFIGURATION line-M-4IO-RV	60
7.4.1.- CONFIGURATION OF DIGITAL INPUTS 1 ... 4.....	61
7.4.2.- CONFIGURATION OF RELAY OUTPUTS 1 ... 4	61
7.5.- MODBUS MEMORY MAP Line-M-4IO-RV.....	61
7.5.1.- INPUT AND OUTPUT STATUS	61
7.5.2.- ALARMS	61
7.5.3.- DEVICE CONFIGURATION VARIABLES.....	61

7.6.- TECHNICAL FEATURES: Line-M-410-RV	62
8.- LINE-M-EXT-PS	64
8.1.- INSTALLATION	64
8.2.- DEVICE TERMINALS.....	65
8.3.- CONNECTION DIAGRAM	65
8.3.1.- MAXIMUM CONNECTION.....	65
8.3.2.- MULTIPLE CONNECTION Line-M-EXT-PS	66
8.4.- LED INDICATORS	66
8.5.- TECHNICAL FEATURES: Line-M-EXT-PS	67
9.- LINE-M-3G	68
9.1.- INSTALLATION OF THE SIM CARD	68
9.2.- LED INDICATORS.....	69
9.3.- COMMUNICATIONS	70
9.3.1.- USAGE ENVIRONMENT AND HEALTH	70
9.3.2.- 3G COMMUNICATIONS	70
9.4.- TECHNICAL FEATURES: line-M-3G.....	71
10.- LINE-TCPRS1	73
10.1.- INSTALLATION	73
10.2.- DEVICE TERMINALS	73
10.3.- LED INDICATORS.....	74
10.4.- COMMUNICATIONS	75
10.4.1.- USAGE ENVIRONMENT AND HEALTH	75
10.4.2.- Wi-Fi COMMUNICATIONS	75
10.4.3.- Bluetooth® COMMUNICATIONS.....	75
10.4.4.- CONFIGURATION WEBSITE	75
10.4.5.- MOBILE APP	78
10.5.- TECHNICAL FEATURES: line-TCPRS1	79
11.- LINE-M-20I	81
11.1.- INSTALLATION.....	81
11.2.- DEVICE TERMINALS.....	81
11.3.- CONNECTION DIAGRAM.....	82
11.4.- LED INDICATORS.....	83
11.5.- MODBUS MEMORY MAP.....	83
11.5.1.- DIGITAL INPUTS	83
11.5.2.- PULSE METERS	84
11.5.3.- OTHER DEVICE PARAMETERS.....	85
11.5.4.- DEVICE CONFIGURATION VARIABLES	85
11.6.- TECHNICAL FEATURES: line-M-20I.....	86
12.- LINE-LM20I-TCP KIT	88
12.1.- INSTALLATION	88
12.2.- DEVICE TERMINALS	89
12.3.- CONNECTION DIAGRAM	90
12.4.- LED INDICATORS	91
12.5.- MODBUS MEMORY MAP	92
12.6.- COMMUNICATIONS.....	92
12.6.1.- USAGE ENVIRONMENT AND HEALTH.....	92
12.6.2.- Wi-Fi COMMUNICATIONS.....	92
12.6.3.- Bluetooth® COMMUNICATIONS.....	92
12.6.4.- CONFIGURATION WEBSITE	93
12.6.5.- MOBILE APP	93
12.7.- TECHNICAL FEATURES: line-LM20I-TCP kit.....	93
13.- LINE-LM40I-TCP KIT	96
13.1.- INSTALLATION	96
13.2.- DEVICE TERMINALS	97
13.3.- CONNECTION DIAGRAM	98
13.4.- LED INDICATORS	99
13.5.- MODBUS MEMORY MAP	100
13.6.- COMMUNICATIONS.....	100
13.6.1.- USAGE ENVIRONMENT AND HEALTH.....	100
13.6.2.- Wi-Fi COMMUNICATIONS	100
13.6.3.- Bluetooth® COMMUNICATIONS.....	100
13.6.4.- CONFIGURATION WEBSITE.....	101

13.6.5.- MOBILE APP	101
13.7.- TECHNICAL FEATURES: line-LM40I-TCP kit.....	101
14.- MAINTENANCE AND TECHNICAL SERVICE	104
15.- GUARANTEE.....	104
16.- CE CERTIFICATE	105
ANNEX A.- CONFIGURATION MENUS.....	108
A.1.- line-M-4IO-R, line-M-4IO-T and line-M-4IO-RV.....	108
A.2.- line-M-4IO-A.....	110





REVISION LOG

Table 1: Revision log.

Date	Revision	Description
03/20	M239B01-03-19A	First Version
06/20	M239B01-03-20A	Changes in the following sections: 2.- 3.2.- 4.2.- 4.4.1.1.- 4.5.4.1.- 4.6.- 5.2.- 5.6.- 6.6.- 7.2.- 7.6.- 9.- 10.- 11.- 14.
11/20	M239B01-03-20B	Changes in the following sections: 2.- 9.4.- 10.- 10.2.- 10.3.- 10.4.5.- 11.- 11.1.- 12.- 13.
05/21	M239B01-03-21A	Changes in the following sections: 10.

SYMBOLS

Table 2: Symbols.

Symbol	Description
	In accordance with the relevant European directive.
	In accordance with the CMiM directive.
	Device covered by European Directive 2012/19/EC. At the end of its useful life, do not leave the device in a household refuse bin. Follow local regulations on electronic equipment recycling.
	Direct current.
	Alternating current.

Note: The images of the devices are for illustrative purposes only and may differ from the original device.

1 - VERIFICATION UPON RECEPTION

Upon reception of the device check the following points:

- The device meets the specifications described in your order.
- The device has not suffered any damage during transport.
- Perform an external visual inspection of the device prior to switching it on.
- Check that it has been delivered with the following:
 - An installation guide
 - An expansion connector.
 - 4 clamping clips.



If any problem is noticed upon reception, immediately contact the transport company and/or **CIRCUTOR**'s after-sales service

2 - PRODUCT DESCRIPTION

The **line-CVM** and **line-EDS** devices have expansion modules to increase their performance.

The expansion modules available are:

- ✓ **line-M-4IO-R**, expansion module with 4 digital inputs and 4 relay outputs.
- ✓ **line-M-4IO-T** expansion module, with 4 digital inputs and 4 transistor outputs.
- ✓ **line-M-4IO-A**, expansion module with 4 analogue inputs and outputs.
- ✓ **line-M-4IO-RV**, expansion module with 4 digital inputs (230 V~) and 4 relay outputs.
- ✓ **Line-M-EXT-PS**, power adapter module.
- ✓ **line-M-3G**, expansion module that adds 3G connectivity to **line-EDS** devices.
- ✓ **line-M-20I**, hub with 20 digital inputs.
- ✓ **line-TCPRS1**, RS-485/RS-232 to TCP/IP converter.
- ✓ **line-LM20I-TCP kit**, hub with 20 digital inputs that includes an RS-485/RS-232 to TCP/IP converter.
- ✓ **line-LM40I-TCP kit**, hub with 40 digital inputs that includes an RS-485/RS-232 to TCP/IP converter.

Each **line-CVM** or **line-EDS** device enables up to 2 expansion modules to be directly connected to their right-hand side.⁽¹⁾

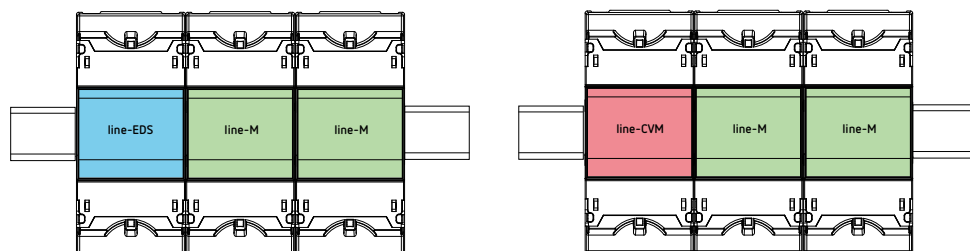

Figure 1: Line-EDS and line CVM expansion module connection.

⁽¹⁾ Expansion module types: **line-M-4IO-R**, **line-M-4IO-T**, **line-M-4IO-RV**, **line-M-4IO-A** and **line-TCPRS1**.

The **line-M-3G** module can only be connected on the left side of **line-EDS** devices. If the **line-EDS** has a **line-M-3G** connected to it, only 1 expansion module can be connected on its right side.

In installations with **line-EDS** devices a total of up to seven devices may be connected to their right-hand side.

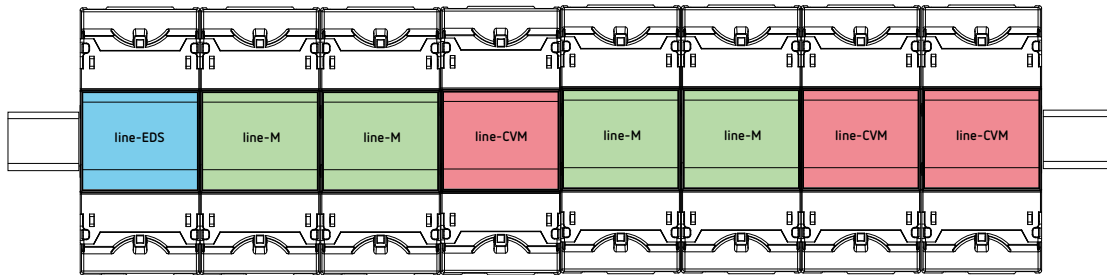

Figure 2: Typical installation of a line-EDS with 7 devices.

Note: An installation may only be fitted with one **line-EDS** device.

Note: In installations without **line-EDS** devices only one **line-CVM** may be installed.

Note: All **line-EDS** or **line-CVM** must be connected to the auxiliary power supply.

3.- INSTALLATION OF THE DEVICE

3.1.- PRELIMINARY RECOMMENDATIONS



In order to use the device safely, personnel operating it must follow the safety measures that comply with the standards of the country where it is to be installed; operators must wear the required personal protective equipment (rubber gloves, approved facial protection and flame-resistant clothing) to prevent injuries from electric shock or arcs caused by exposure to current-carrying conductors, and they must heed the various warnings indicated in this instruction manual.

The **line-M** device must be installed by authorised, qualified personnel.

The power supply plug must be disconnected and measurement systems switched off before handling, altering the connections or replacing the device. It is dangerous to handle the device while it is powered.

Cables must always be kept in perfect condition to avoid accidents or injury to personnel or installations.

Restrict the operation of the device to the specified measurement category, voltage or current values.

The manufacturer of the device is not responsible for any damage resulting from failure by the user or installer to heed the warnings and/or recommendations set out in this manual, nor for damage resulting from the use of non-original products or accessories or those made by other manufacturers.

Do not use the device to take any measurements if an anomaly or malfunction is detected.

Check the surrounding environment before starting to take measurements. Do not take any measurements in hazardous or explosive environments.





Before carrying out maintenance, repair or handling of any of the device's connections, the device must be disconnected from all power sources, both from the device's own power supply and the measurement's.
Contact the after-sales service if you detect that the device is not working properly.

3.2.- INSTALLATION

	<p>When the device is on, its terminals, opening covers or removing elements may expose the user to parts that are hazardous to touch. Do not use the device until it is fully installed.</p>
---	---

The device must be installed inside electric panel or enclosure, with DIN rail mounting (IEC 60715).

	<p>Before installing the expansion module, the line-CVM or line-EDS devices must be disconnected from all power supplies, both the device's power supply itself and the measurement's.</p>
---	--

	<p>The line-M-3G module can only be connected on the left side of the line-EDS device.</p>
---	--

	<p>The line-CVM and line-EDS devices may only have 2 expansion modules connected to their right-hand side. If the line-EDS has a line-M-3G connected to it, only 1 expansion module can be connected on its right side. See "2.- PRODUCT DESCRIPTION".</p>
---	---

The steps to follow to connect the expansion modules are:

1.- Using a flat head screwdriver, remove the expansion connector's protective covers located on the side of the devices, (**Figure 3**).

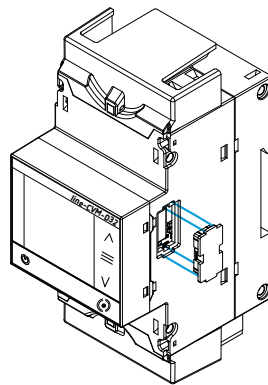

Figure 3: Installation step 1.

2.- Insert the expansion connector and fastening clips into one of the devices (**Figure 4**).

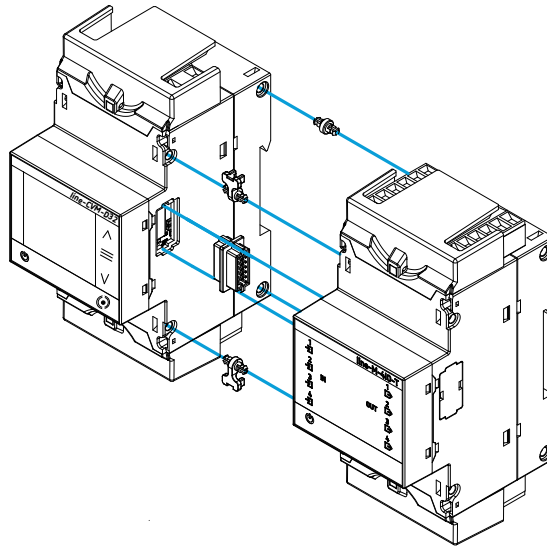

Figure 4: Installation step 2.

3.- Connect both devices and fasten them by pushing the front clips down (Figure 5).

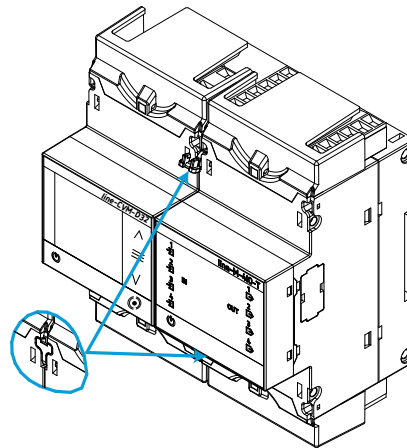

Figure 5: Installation step 3.

3.3.- PANEL ADAPTER 72 x 72 mm

Note: The panel adapter 72 x 72 mm is a separately sold accessory.

CIRCUTOR has a panel adapter for the **line-M** expansion modules for their installation on 72 x 72 mm panels.

The **Figure 6** illustrates how the panel adapter connects to a **line-M**.



Before installing the adapter, the device must be disconnected from all power and measurement supplies.

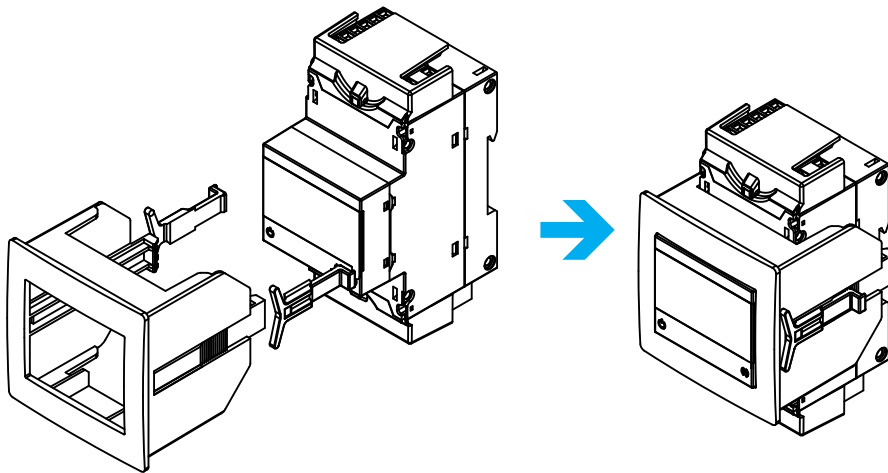

Figure 6: Installation of the panel adapter.

Table 3: Technical characteristics of the Panel Adapter.

Technical Specifications	
Protection degree	IP40
Enclosure	Self-extinguishing V0 plastic

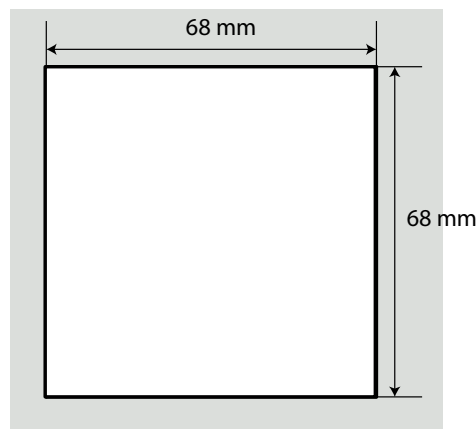

Figure 7: Cut in the panel.

4.- line-M-4IO-R

The line-M-4IO-R expansion module has 4 digital inputs and 4 relay outputs.



4.1.- DEVICE TERMINALS

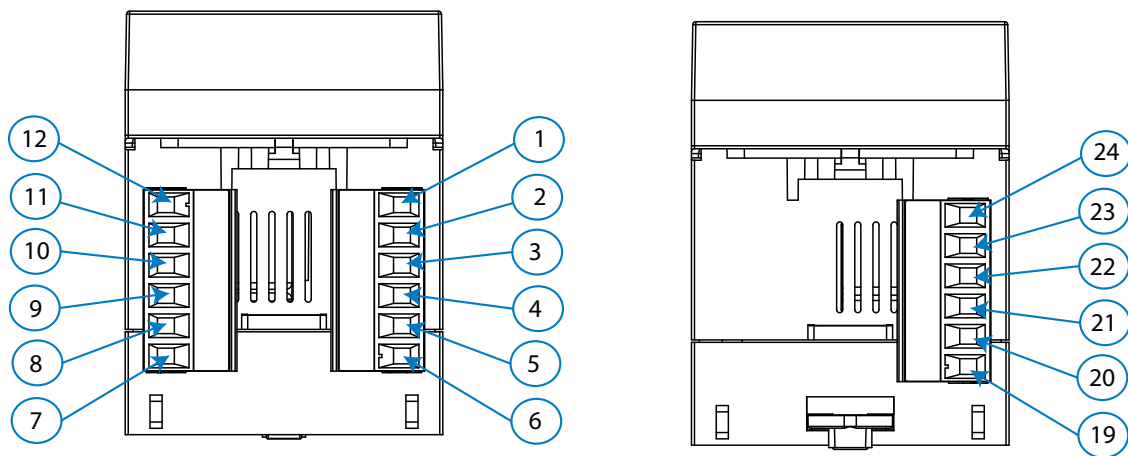

Figure 8: Line-M-4IO-R terminals: Upper - Lower.

Table 4: List of line-M-4IO-R terminals.

Device terminals	
1: C, Common digital inputs	10: NO, Relay Output 1 (NO)
2: 1, Digital input 1	11: C, Relay output 1 (Common)
3: 2, Digital input 2	12: NC, Relay output 1 (NC)
4: 3, Digital input 3	19: NO, Relay output 4 (NO)
5: 4, Digital input 4	20: C, Relay output 4 (Common)
6: Vcc, + 12V	21: NC, Relay output 4 (NC)
7: NO, Relay output 2 (NO)	22: NO, Relay output 3 (NO)
8: C, Relay output 2 (Common)	23: C, Relay output 3 (Common)
9: NC, Relay output 2 (NC)	24: NC, Relay output 3 (NC)

4.2. - CONNECTION DIAGRAM

Enabling digital inputs with the device's internal source (+12 V)

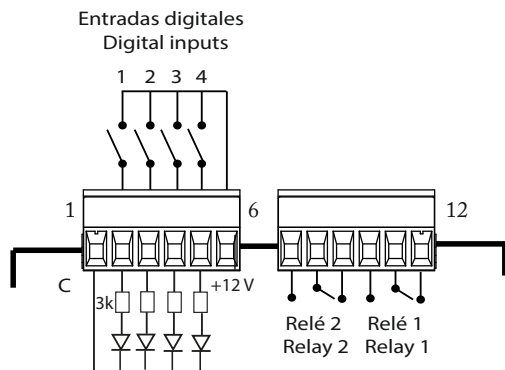

Enabling digital inputs with an external source (+24 V)

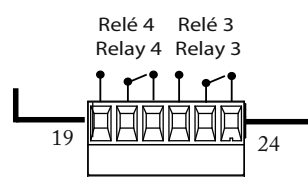
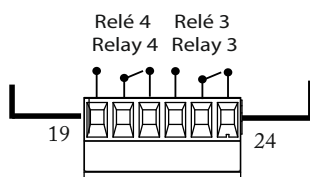
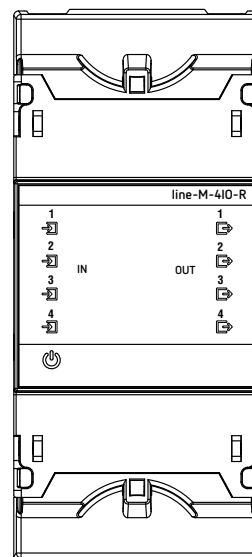
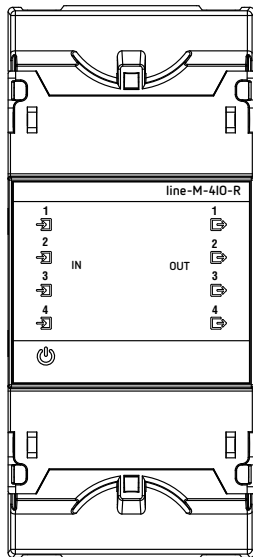
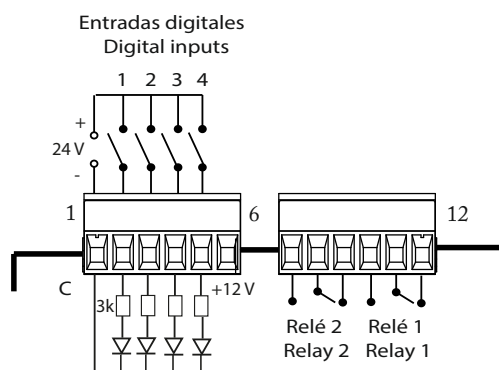

Figure 9: Line-M-4IO-R connection diagram.

4.3 .- LED INDICATORS

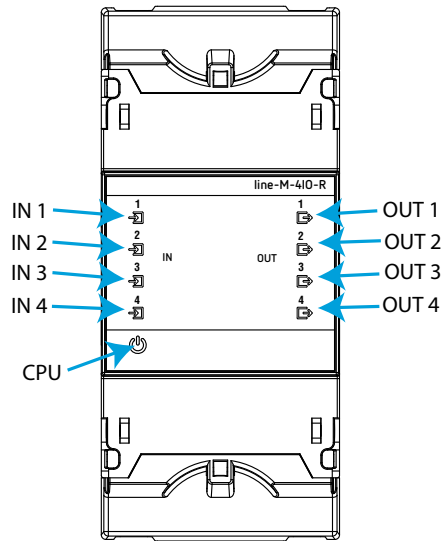

Figure 10: LEDs: line-M-4IO-R.

The **line-M-4IO-R** have 9 indicating LEDs:

✓ **CPU**, Indicates device status:

Table 5: CPU LED.

LED	Description
CPU	Flashing:
	<i>White</i> : Indicates that the device is powered

✓ **IN x**, Indicates digital input x status:

Table 6: Led IN x.

LED	Description
IN x	On:
	<i>Green</i> : Indicates activated input

✓ **OUT x**, Indicates relay output x status:

Table 7: LED OUT x.

LED	Description
OUT x	On:
	<i>Red</i> : Indicates activated output

4.4.- CONFIGURATION line-M-4IO-R

Configuration via display of the **line-M-4IO-R** is carried out via **line-CVM** to which it is connected. To access the configuration menu, hold down (>2s) key .

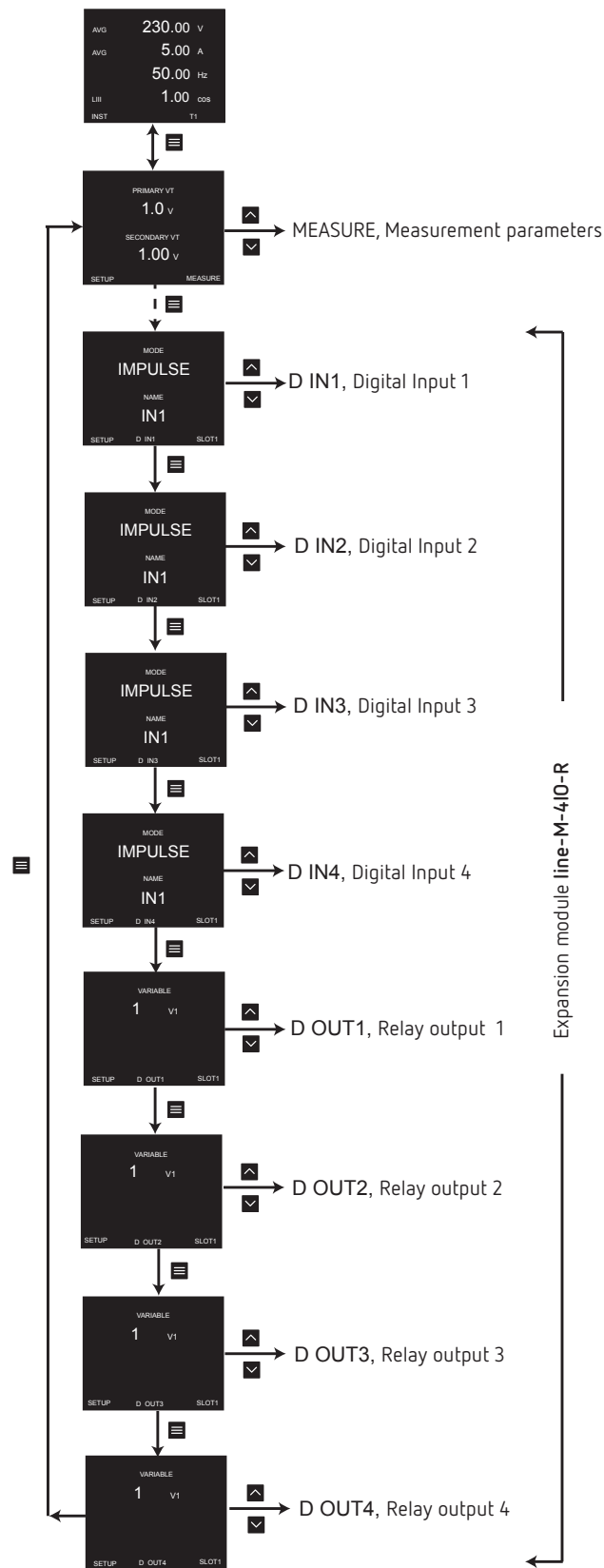



Figure 11: Configuration menu.

Note: SLOT1 is the expansion module nearest **line-CVM**, SLOT2 is the following expansion module.

To exit the configuration menu, hold down (>2s) key .

4.4.1.- CONFIGURATION OF DIGITAL INPUTS 1 ... 4



Note: Digital input *x* configuration is identified by the literal **D IN_x** at the bottom centre of the display.

4.4.1.1.- Mode and name of digital input *x*

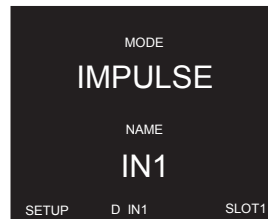
The operating mode and name of digital input *x* are configured on this screen.



Hold down key  to set **operating mode (MODE)**.

Use keys  and  to skip through the different options:

IMPULSE, The digital input functions as a pulse input.

STATUS, Functions as a status input

TARIFF, It enables selection of tariff.

Note: The option **TARIFF** is only available for Digital inputs 1 and 2.



Note: To select the **TARIFF**, digital inputs 1 and 2 are needed simultaneously.

Note: If 2 modules are configured in the **TARIFF** option, the device will apply the tariff set in the second module.

Table 8: Tariff selection.

	D IN2	D IN1
Tariff 1	0	0
Tariff 2	0	1
Tariff 3	1	0
Tariff 4	1	1

Hold down key  to set **input name (NAME)**.

Use keys  and  to modify the digit's value.

Press key  to skip through the digits.

To validate the option, hold down key .

Use key  to skip to the next programming point.

4.4.1.2.- Units and energy per pulse

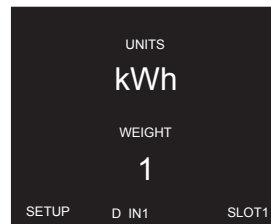

Note: Screen visible if the selected operating mode is a pulse input, **IMPULSE**.

This screen enables unit and energy per pulse configuration.



Hold down key  to set the **units (UNITS)**.

Hold down key  to set the **energy per pulse (WEIGHT)**.

Use keys  and  to modify the digit's value.

Press key  to skip through the digits.

To validate the option, hold down key .

Use key  to skip to the next programming point.



4.4.1.3.- Decimals

Note: Screen visible if the selected operating mode is a pulse input, **IMPULSE**.

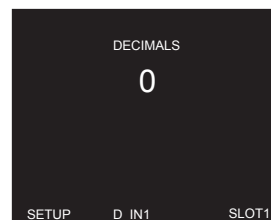
This screen enables decimal number configuration.



Hold down key  to set **number of decimals (DECIMALS)**.

Use keys  and  to modify the digit's value.

To validate the option, hold down key .

✓ **No. of decimals:**

Minimum value: 0.

Maximum value: 9.

Use key  to skip to the next programming point.



4.4.1.4.- Input signal logic

Note: Screen visible if the selected operating mode is a pulse input, **STATUS**.

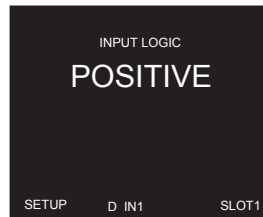
This screen enables configuration of input signal operating logic.





Hold down key  to set the **operating logic (INPUT LOGIC)**.

Use keys  and  to skip through the different options:

POSITIVE, Positive logic, a high signal input shows 1 and a low signal input shows 0.

NEGATIVE, Negative logic, a high signal input shows 0 and a low signal input shows 1.

To validate the option, hold down key .

Use key  to skip to the next programming point.

4.4.2.- CONFIGURATION OF RELAY OUTPUTS 1 ... 4



Note: Configuration of relay output x is shown by the literal **D OUT x** at the bottom centre of the display.

4.4.2.1.- Variable

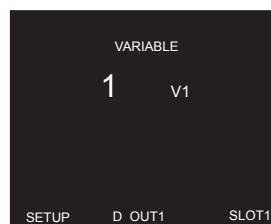
This screen enables configuration of the **relay output variable (VARIABLE)**.



Hold down key  to enter programming mode.

Use keys  and  to modify the digit's value.

Press key  to skip through the digits.

The codes for the variables are shown in **Table 9**, **Table 10**, **Table 11** and **Table 12**.

To validate the option, hold down key .

Use key  to skip to the next programming point.

Table 9: Variable codes for Output programming (Table 1).

Parameter	Phase	Code	Phase	Code	Phase	Code	Phase	Code
Phase-Neutral voltage	L1	1	L2	9	L3	17	III	31
Phase-Phase voltage	L12	28	L23	29	L31	30	III	32
Current	L1	2	L2	10	L3	18	III	33
Frequency	-	27	-	-	-	-	-	-
Total Active Power	L1	3	L2	11	L3	19	III	34
Consumed Active Power	L1	700	L2	707	L3	714	III	721
Generated Active Power	L1	728	L2	735	L3	742	III	749
Total Apparent Power	L1	6	L2	14	L3	22	III	37
Consumed Apparent Power	L1	704	L2	711	L3	718	III	725
Generated Apparent Power	L1	732	L2	739	L3	746	III	753
Total Reactive Power	L1	69	L2	70	L3	71	III	72
Total Consumed Reactive Power	L1	703	L2	710	L3	717	III	724
Total Generated Reactive Power	L1	731	L2	738	L3	745	III	752
Total Inductive Reactive Power	L1	4	L2	12	L3	20	III	35
Consumed Inductive Reactive Power	L1	701	L2	708	L3	715	III	722
Generated Inductive Reactive Power	L1	729	L2	736	L3	743	III	750
Total Capacitive Reactive Power	L1	5	L2	13	L3	21	III	36
Consumed Capacitive Reactive Power	L1	702	L2	709	L3	716	III	723
Generated Capacitive Reactive Power	L1	730	L2	737	L3	744	III	751
Total Power Factor	L1	7	L2	15	L3	23	III	38
Generated Power Factor	L1	705	L2	712	L3	719	III	726
Consumed Power Factor	L1	733	L2	740	L3	747	III	754
Cos φ Total	L1	8	L2	16	L3	24	III	39
Cos φ Generated	L1	706	L2	713	L3	720	III	727
Cos φ Consumed	L1	734	L2	741	L3	748	III	755
THD% Voltage ⁽³⁾	L1	40	L2	41	L3	42	-	-
THD % Current ⁽³⁾	L1	44	L2	45	L3	46	-	-
Quality Parameter ⁽²⁾⁽³⁾	L1	109	L2	110	L3	111	III	112

⁽²⁾ The output is activated when any of the quality parameters (overvoltage, gap or interruption) meet the programmed parameters.

⁽³⁾ These variables are not present when programming the Analogue Output variables.

The outputs are also configurable depending on the digital or analogue inputs of the connected expansion modules (Table 10).

Note: SLOT1 is the expansion module nearest line-CVM, SLOT2 is the following expansion module.

The code MANUAL⁽⁴⁾ is used to manually activate the output, see "4.4.2.8. - Manual operation of the relay output".

Table 10: Variable codes for Output programming (Table 2).

Parameter	IN	Code	IN	Code	IN	Code	IN	Code
Digital input SLOT1	1	902	2	903	3	904	4	905
Digital input SLOT2	1	910	2	911	3	912	4	913
Analogue input SLOT1	1	934	2	935	3	936	4	937
Analogue input SLOT1	1	942	2	943	3	944	4	945
MANUAL ⁽⁴⁾		0						

Table 11: Variable codes for Output programming (Table 3).

Parameter	Tariff	Code	Tariff	Code	Tariff	Code
Maximum Current Demand L1 ⁽³⁾	T1	600	T2	612	T3	624
	T4	636	-	-	-	-
Maximum L2 Current Demand L2 ⁽³⁾	T1	601	T2	613	T3	625
	T4	637	-	-	-	-
Maximum Current Demand L3	T1	602	T2	614	T3	626
	T4	638	-	-	-	-
Maximum Current Demand III ⁽³⁾	T1	603	T2	615	T3	627
	T4	639	-	-	-	-
Maximum Active Power Demand L1 ⁽³⁾	T1	604	T2	616	T3	628
	T4	640	-	-	-	-
Maximum Active Power Demand L2 ⁽³⁾	T1	605	T2	617	T3	629
	T4	641	-	-	-	-
Maximum Active Power Demand L3 ⁽³⁾	T1	606	T2	618	T3	630
	T4	642	-	-	-	-
Maximum Active Power Demand III ⁽³⁾	T1	607	T2	619	T3	631
	T4	643	-	-	-	-
Maximum Apparent Power Demand L1 ⁽³⁾	T1	608	T2	620	T3	632
	T4	644	-	-	-	-
Maximum Apparent Power Demand L2 ⁽³⁾	T1	609	T2	621	T3	633
	T4	645	-	-	-	-
Maximum Apparent Power Demand L3 ⁽³⁾	T1	610	T2	622	T3	634
	T4	646	-	-	-	-
Maximum Apparent Power Demand III ⁽³⁾	T1	611	T2	623	T3	635
	T4	647	-	-	-	-
Consumption hour no.	T1	531	T2	537	T3	543
	T4	549	Total	585	-	-
Generation hour no.	T1	534	T2	540	T3	546
	T4	552	Total	588	-	-
Consumption cost	T1	529	T2	535	T3	541
	T4	547	Total	583	-	-
Generation cost	T1	532	T2	538	T3	544
	T4	550	Total	586	-	-
CO ₂ emissions from consumption	T1	530	T2	536	T3	542
	T4	548	Total	584	-	-

Table 11 (Continuation): Variable codes for Output programming (Table 3).

Parameter	Tariff	Code	Tariff	Code	Tariff	Code
CO ₂ emissions from generation	T1	533	T2	539	T3	545
	T4	551	Total	587	-	-

Table 12: Variable codes for Output programming (Energy Pulses).

Parameter	L1		L2		L3		III	
	Tariff	Code	Tariff	Code	Tariff	Code	Tariff	Code
Consumed Active Energy	T1	129	T1	134	T1	139	T1	144
	T2	169	T2	174	T2	179	T2	184
	T3	209	T3	214	T3	219	T3	224
	T4	249	T4	254	T4	259	T4	264
	Total	489	Total	494	Total	499	Total	504
Generated Active Energy	T1	149	T1	154	T1	159	T1	164
	T2	189	T2	194	T2	199	T2	204
	T3	229	T3	234	T3	239	T3	244
	T4	269	T4	274	T4	279	T4	284
	Total	509	Total	514	Total	519	Total	524
Consumed Reactive Energy	T1	132	T1	137	T1	142	T1	147
	T2	172	T2	177	T2	182	T2	187
	T3	212	T3	217	T3	222	T3	227
	T4	252	T4	257	T4	262	T4	267
	Total	492	Total	497	Total	502	Total	507
Generated Reactive Energy	T1	152	T1	157	T1	162	T1	167
	T2	192	T2	197	T2	202	T2	207
	T3	232	T3	237	T3	242	T3	247
	T4	272	T4	277	T4	282	T4	287
	Total	512	Total	517	Total	522	Total	527
Consumed Inductive Reactive Energy	T1	130	T1	135	T1	140	T1	145
	T2	170	T2	175	T2	180	T2	185
	T3	210	T3	215	T3	220	T3	225
	T4	250	T4	255	T4	260	T4	265
	Total	490	Total	495	Total	500	Total	505
Generated Inductive Reactive Energy	T1	150	T1	155	T1	160	T1	165
	T2	190	T2	195	T2	200	T2	205
	T3	230	T3	235	T3	240	T3	245
	T4	270	T4	275	T4	280	T4	285
	Total	510	Total	515	Total	520	Total	525
Consumed Capacitive Reactive Energy	T1	131	T1	136	T1	141	T1	146
	T2	171	T2	176	T2	181	T2	186
	T3	211	T3	216	T3	221	T3	226
	T4	251	T4	256	T4	261	T4	266
	Total	491	Total	496	Total	501	Total	506

Table 12 (Continuation): Variable codes for Output programming (Energy Pulses).

Parameter	L1		L2		L3		III	
	Tariff	Code	Tariff	Code	Tariff	Code	Tariff	Code
Generated Capacitive Reactive Energy	T1	151	T1	156	T1	161	T1	166
	T2	191	T2	196	T2	201	T2	206
	T3	231	T3	236	T3	241	T3	246
	T4	271	T4	276	T4	281	T4	286
	Total	511	Total	516	Total	521	Total	526
Consumed Apparent Energy	T1	133	T1	138	T1	143	T1	148
	T2	173	T2	178	T2	183	T2	188
	T3	213	T3	218	T3	223	T3	228
	T4	253	T4	258	T4	263	T4	268
	Total	493	Total	498	Total	503	Total	508
Generated Apparent Energy	T1	153	T1	158	T1	163	T1	168
	T2	193	T2	198	T2	203	T2	208
	T3	233	T3	238	T3	243	T3	248
	T4	273	T4	278	T4	283	T4	288
	Total	513	Total	518	Total	523	Total	528

4.4.2.2.- Maximum and minimum values

Note: Screen visible if the selected digital output variable is in **Table 9**, **Table 10** or **Table 11**.

This screen enables maximum and minimum alarm variable configuration.

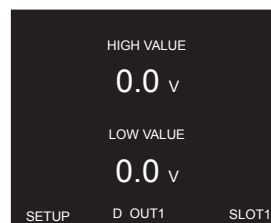

Hold down key to set **maximum value (HIGH VALUE)**, i.e. the value above which the alarm is activated.
 Hold down key to set **minimum value (LOW VALUE)**, i.e. the value below which the alarm is activated.

Use keys and to modify the digit's value.
 Press key to skip through the digits.

Note: maximum and minimum programming value depends on the selected variable.

Hold down key to validate the value.
 Use key to skip to the next programming point.

4.4.2.3.- Connection and disconnection delay

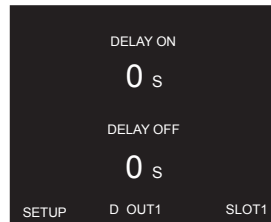

Note: Screen visible if the selected digital output variable is in [Table 9](#), [Table 10](#) or [Table 11](#).

This screen enables alarm connection and disconnection delay configuration in seconds.



Hold down key  to set **connection delay** (DELAY ON).

Hold down key  to set **disconnection delay** (DELAY OFF).

Use keys  and  to modify the digit's value.

Press key  to skip through the digits.

✓ **Connection and Disconnection delay:**

Minimum value: 0 s.

Maximum value: 65499 s.

Hold down key  to validate the value.

Use key  to skip to the next programming point.



4.4.2.4.- Hysteresis and status of contacts

Note: Screen visible if the selected digital output variable is in [Table 9](#), [Table 10](#) or [Table 11](#).

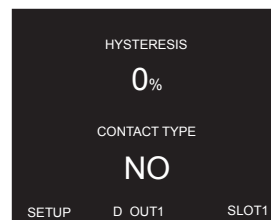
This screen enables hysteresis value and contact status configuration.



Hold down key  to set **hysteresis value** (HYSTERESIS), the difference between the alarm on and off value in %.

Use keys  and  to modify the digit's value.

Press key  to skip through the digits.

✓ **Hysteresis:**

Minimum value: 0%.

Maximum value: 99%.

Hold down key  to set **contact status (CONTACT TYPE)**.

Use keys  and  to skip through the different options:

NC, Contact normally closed.
NO, Contact normally open.

Hold down key  to validate the value.

Use key  to skip to the next programming point.

4.4.2.5.- Latch

Note: Screen visible if the selected digital output variable is in *Table 9, Table 10 or Table 11*.

This screen enables alarm latch configuration.

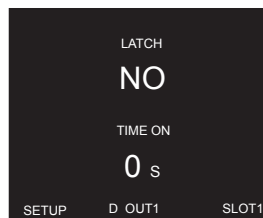



Hold down key  to set latch (**LATCH**), i.e. if it remains interlocked after the alarm is triggered, even if the event that triggered it disappears.

Use keys  and  to skip through the different options:

NO, Latching is not activated.
YES, Latching is activated.
TIME, Alarm latching is activated for a set time, **Latching time**.

Hold down key  to validate the value.

Hold down key  to set **Latching time (TIME ON)**. The time in seconds that the alarm is interlocked is displayed. After such time, if the alarm status no longer applies, disconnection delay is activated.

Use keys  and  to modify the digit's value.

Press key  to skip through the digits.

✓ Latching time:

Minimum value: 0 s.

Maximum value: 65499 s.

Hold down key  to validate the value.

Use key  to skip to the next programming point.



4.4.2.6.- Energy per pulse and contact status

Note: Screen visible if the selected digital output variable is an energy, see [Table 12](#).

This screen enables energy per pulse and contact status configuration.



Hold down key  to set the **energy per pulse (WEIGHT)**.

Use keys  and  to modify the digit's value.

Press key  to skip through the digits.

✓ **Energy per pulse:**

Minimum value: 1 wh / varLh / varCh / varh / VAh.

Maximum value: 1999999 wh / varLh / varCh / varh / VAh.

Hold down key  to validate the value.

Hold down key  to set **contact status (CONTACT TYPE)**.

Use keys  and  to skip through the different options:

NC, Contact normally closed.

NO, Contact normally open.

Hold down key  to validate the value.

Use key  to skip to the next programming point.

4.4.2.7.- Pulse

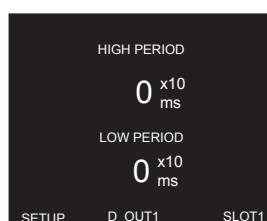

Note: Screen visible if the selected digital output variable is an energy, see [Table 12](#).

This screen enables pulse width configuration



Hold down key  to set **pulse width** to a high level (**HIGH PERIOD**).

Hold down key  to set **pulse width** to a low level (**LOW PERIOD**).

Use keys  and  to modify the digit's value.

Press key  to skip through the digits.

✓ Pulse width:

Minimum value: 0 x 10 ms.

Maximum value: 999 x 10 ms.

Hold down key  to validate the value.

Use key  to skip to the next programming point.



4.4.2.8.- Manual operation of the relay output

Note: Screen visible if the selected relay output variable is **MANUAL**, see *Table 10*.

This screen enables manual relay output activation.



Hold down key  to set **output status (STATUS)**.

Use keys  and  to skip through the different options:

OFF, Disconnected output.

ON, Connected output.

Hold down key  to set **contact status (CONTACT TYPE)**.

Use keys  and  to skip through the different options:

NC, Contact normally closed.

NO, Contact normally open.

Hold down key  to validate the value.

Use key  to skip to the next programming point.

4.5.- MODBUS MEMORY MAP line-M-4IO-R

Note: For all modbus map parameters, SLOT1 corresponds to the first expansion module connected to the right-hand side of the line-CVM-D and SLOT2 corresponds to the second connected module.

4.5.1.- INPUT AND OUTPUT STATUS

The **Function 0x02**, is implemented for these variables.

Table 13: Modbus Memory Map: Output and input status.

Parameter	Format	Address		Value
		SLOT 1	SLOT 2	
Digital input 1	bool	C5A8	C990	0: Deactivated - 1: activated
Digital input 2	bool	C5AC	C994	0: Deactivated - 1: activated
Digital input 3	bool	C5B0	C998	0: Deactivated - 1: activated
Digital input 4	bool	C5B4	C99C	0: Deactivated - 1: activated
Relay output 1	bool	C679	CA61	0: Deactivated - 1: activated
Relay output 2	bool	C68D	CA75	0: Deactivated - 1: activated
Relay output 3	bool	C6A1	CA89	0: Deactivated - 1: activated
Relay output 4	bool	C6B5	CA9D	0: Deactivated - 1: activated

4.5.2.- PULSE METERS

The **Function 0x04**: register readout, is implemented for these variables.

Table 14: Modbus Memory Map: Pulse meter.

Parameter	Format	Address	
		SLOT 1	SLOT 2
Pulse counter of digital input 1	Uint [64]	C5A8 - C5A9 - C5AA - C5AB	C990 - C991 - C992 - C993
Pulse counter of digital input 2	Uint [64]	C5AC - C5AD - C5AE - C5AF	C994 - C995 - C996 - C997
Pulse counter of digital input 3	Uint [64]	C5B0 - C5B1 - C5B2 - C5B3	C998 - C999 - C99A - C99B
Pulse counter of digital input 4	Uint [64]	C5B4-C5B5- C5B6-C5B7	C99C-C99D- C99E-C99F

Parameter deletion is carried out by **Function 05**: writing a relay.

Table 15: Modbus Memory Map: Pulse meter deletion.

Deleting parameters	Format	Address		Value to be sent
		SLOT 1	SLOT 2	
Deleting the pulse counter from digital input 1	Bool	C710	CAF8	0xFF00
Deleting the pulse counter from digital input 2	Bool	C711	CAF9	0xFF00
Deleting the pulse counter from digital input 3	Bool	C712	CAFA	0xFF00
Deleting the pulse counter from digital input 4	Bool	C713	CAFB	0xFF00

4.5.3.- ALARMS

The Function 0x04, is implemented for these variables.

Table 16: Modbus Memory Map: Alarms.

Parameter	Format	Address		Units ⁽⁵⁾
		SLOT 1	SLOT 2	
Output relay 1 alarm activation date	Uint [32]	C677-C678	CA5F-CA60	Epoch
Output relay 2 alarm activation date	Uint [32]	C68B-C68C	CA73-CA74	Epoch
Output relay 3 alarm activation date	Uint [32]	C69F-6CA0	CA87-CA88	Epoch
Output relay 4 alarm activation date	Uint [32]	C6B3-C6B4	CA9B-CA9C	Epoch

⁽⁵⁾ Date and time are given in Epoch format.

4.5.4.- DEVICE CONFIGURATION VARIABLES

The following functions are used for these variables:

Function 0x03: register readout.

Function 0x10: Writing multiple registers.

4.5.4.1.- Digital Input Configuration

Table 17: Modbus Memory Map: Digital Inputs.

SLOT 1				
Digital Input 1				
Parameter	Format	Address	Valid data range	Default value
Mode ^{(6) (7)}	Int [16]	C4E0	- 1: Tariff - 0: Status input - > 0: Pulse input (energy per pulse) ⁽⁸⁾	0
Name	String	C4E3-C4E4- C4E5-C4E6	-	-
Units ⁽⁹⁾	String	C4E7-C4E8-C4E9	-	-
Decimals ⁽⁹⁾	Uint [16]	C4E2	0... 9	0
Input signal logic ⁽¹⁰⁾	Uint [16]	C4E1	0: Positive logic 1: Negative logic	0
Digital input 2				
Mode ^{(6) (7)}	Int [16]	C4EC	- 1: Tariff - 0: Status input - > 0: Pulse input (energy per pulse) ⁽⁸⁾	0
Name	String	C4EF-C4F0- C4F1-C4F2	-	-
Units ⁽⁹⁾	String	C4F3-C4F4-C4F5	-	-
Decimals ⁽⁹⁾	Uint [16]	C4EE	0... 9	0
Input signal logic ⁽¹⁰⁾	Uint [16]	C4ED	0: Positive logic 1: Negative logic	0
Digital input 3				
Mode	Int [16]	C4F8	0: Status input - > 0: Pulse input (energy per pulse) ⁽⁸⁾	0
Name	String	C4FB-C4FC- C4FD-C4FE	-	-
Units ⁽⁹⁾	String	C4FF-C500-C501	-	-

Table 17 (Continuation): Modbus Memory Map: Digital Inputs.

Parameter	Format	Address	Valid data range	Default value
Decimals ⁽⁹⁾	Uint [16]	C4FA	0... 9	0
Input signal logic ⁽¹⁰⁾	Uint [16]	C4F9	0: Positive logic 1: Negative logic	0
Digital input 4				
Mode	Int [16]	C504	0: Status input - > 0: Pulse input (energy per pulse) ⁽⁸⁾	0
Name	String	C507-C508- C509-C50A	-	-
Units ⁽⁹⁾	String	C50B-C50C- C50D	-	-
Decimals ⁽⁹⁾	Uint [16]	C506	0... 9	0
Input signal logic ⁽¹⁰⁾	Uint [16]	C505	0: Positive logic 1: Negative logic	0
SLOT 2				
Digital Input 1				
Mode ^{(6) (7)}	Int [16]	C8C8	- 1: Tariff - 0: Status input - > 0: Pulse input (energy per pulse) ⁽⁸⁾	0
Name	String	C8CB-C8CC- C8CD-C8CE	-	-
Units ⁽⁹⁾	String	C8CF-C8D0- C8D1	-	-
Decimals ⁽⁹⁾	Uint [16]	C8CA	0... 9	0
Input signal logic ⁽¹⁰⁾	Uint [16]	C8C9	0: Positive logic 1: Negative logic	0
Digital input 2				
Mode ^{(6) (7)}	Int [16]	C8D4	- 1: Tariff - 0: Status input - > 0: Pulse input (energy per pulse) ⁽⁸⁾	0
Name	String	C8D7-C8D8- C8D9-C8DA	-	-
Units ⁽⁹⁾	String	C8DB-C8DC- C8DD	-	-
Decimals ⁽⁹⁾	Uint [16]	C8D6	0... 9	0
Input signal logic ⁽¹⁰⁾	Uint [16]	C8D5	0: Positive logic 1: Negative logic	0
Digital input 3				
Mode	Int [16]	C8E0	0: Status input - > 0: Pulse input (energy per pulse) ⁽⁸⁾	0
Name	String	C8E3-C8E4- C8E5-C8E6	-	-
Units ⁽⁹⁾	String	C8E7-C8E8- C8E9	-	-
Decimals ⁽⁹⁾	Uint [16]	C8E2	0... 9	0
Input signal logic ⁽¹⁰⁾	Uint [16]	C8E1	0: Positive logic 1: Negative logic	0
Digital input 4				
Mode	Int [16]	C8EC	0: Status input - > 0: Pulse input (energy per pulse) ⁽⁸⁾	0
Name	String	C8EF-C8F0- C8F1-C8F2	-	-

Table 17 (Continuation): Modbus Memory Map: Digital Inputs.

Parameter	Format	Address	Valid data range	Default value
Units ⁽⁹⁾	String	C8F3-C8F4-C8F5	-	-
Decimals ⁽⁹⁾	Uint [16]	C8EE	0... 9	0
Input signal logic ⁽¹⁰⁾	Uint [16]	C8ED	0: Positive logic 1: Negative logic	0

⁽⁶⁾ If 2 modules are configured in the **TARIFF** option, the device will apply the tariff set in the second module.

⁽⁷⁾ To select the Tariff mode, Digital Inputs 1 and 2 must be configured as tariffs simultaneously. See **Table 8** to select the tariff.

⁽⁸⁾ To configure the Operating Mode as **pulse input**, this parameter must be set to **Energy per pulse** (Value > 0).

⁽⁹⁾ Parameters to be configured if **pulse input** mode has been selected.

⁽¹⁰⁾ Parameters to be configured if **status input** mode has been selected.

4.5.4.2. - Relay Output Configuration

Table 18: Modbus Memory Map: Relay outputs.

SLOT 1				
Relay output 1				
Configuration parameters	Format	Address	Valid data range	Default value
Variable	Uint [16]	C350	0: Manual - Table 9 - Table 10 - Table 11 - Table 12	0
Maximum value ⁽¹³⁾ / Energy per pulse ⁽¹⁴⁾	Float [32]	C352-C353	Depends on the selected variable	-
Minimum value ⁽¹³⁾	Float [32]	C354-C355	Depends on the selected variable	-
Connection delay	Uint [16]	C356	0... 65499 s	0 s
High level pulse width ⁽¹⁴⁾			0... 999 ms (x10)	
Disconnection delay	Uint [16]	C357	0... 65499 s	0 s
Low level pulse width ⁽¹⁴⁾			0... 999 ms (x10)	
Hysteresis	Uint [16]	C358	0... 99%	0%
Contact status	Uint [16]	C351	0: Normally open - 1: Normally closed	0
Latch	Bool	C359	0: No - 1: Yes	
Latching time	Uint [16]	C35A	0... 65499 s	0 s
Output unlocking ⁽¹¹⁾	Bool	C670	0	0
Manual Operation: Output status ⁽¹¹⁾ ⁽¹²⁾	Bool	C679	ON (Connect output): FF00 OFF (Disconnect output): 0000	0
Relay output 2				
Variable	Uint [16]	C364	0: Manual - Table 9 - Table 10 - Table 11 - Table 12	0
Maximum value ⁽¹³⁾ / Energy per pulse ⁽¹⁴⁾	Float [32]	C366 - C367	Depends on the selected variable	-
Minimum value ⁽¹³⁾	Float [32]	C368 - C369	Depends on the selected variable	-
Connection delay	Uint [16]	C36A	0... 65499 s	0 s
High level pulse width ⁽¹⁴⁾			0... 999 ms (x10)	
Disconnection delay	Uint [16]	C36B	0... 65499 s	0 s
Low level pulse width ⁽¹⁴⁾			0... 999 ms (x10)	
Hysteresis	Uint [16]	C36C	0... 99%	0%
Contact status	Uint [16]	C365	0: Normally open - 1: Normally closed	0

Table 18 (Continuation): Modbus Memory Map: Relay outputs.

Configuration parameters	Format	Address	Valid data range	Default value
Latch	Bool	C36D	0: No - 1: Yes	
Latching time	Uint [16]	C36E	0... 65499 s	0 s
Output unlocking ⁽¹²⁾	Bool	C684	0	0
Manual Operation: Output status ⁽¹¹⁾ ⁽¹²⁾	Bool	C68D	ON (Connect output): FF00 OFF (Disconnect output): 0000	0
Relay output 3				
Variable	Uint [16]	C378	0: Manual - Table 9 - Table 10 - Table 11 - Table 12	0
Maximum value ⁽¹³⁾ / Energy per pulse ⁽¹⁴⁾	Float [32]	C37A-C37B	Depends on the selected variable	-
Minimum value ⁽¹³⁾	Float [32]	C37C-C37D	Depends on the selected variable	-
Connection delay	Uint [16]	C37E	0... 65499 s	0 s
High level pulse width ⁽¹⁴⁾			0... 999 ms (x10)	
Disconnection delay	Uint [16]	C37F	0... 65499 s	0 s
Low level pulse width ⁽¹⁴⁾			0... 999 ms (x10)	
Hysteresis	Uint [16]	C380	0... 99%	0%
Contact status	Uint [16]	C379	0: Normally open - 1: Normally closed	0
Latch	Bool	C381	0: No - 1: Yes	
Latching time	Uint [16]	C382	0... 65499 s	0 s
Output unlocking ⁽¹¹⁾	Bool	C698	0	0
Manual Operation: Output status ⁽¹¹⁾ ⁽¹²⁾	Bool	C6A1	ON (Connect output): FF00 OFF (Disconnect output): 0000	0
Relay output 4				
Variable	Uint [16]	C38C	0: Manual - Table 9 - Table 10 - Table 11 - Table 12	0
Maximum value ⁽¹³⁾ / Energy per pulse ⁽¹⁴⁾	Float [32]	C38E - C38F	Depends on the selected variable	-
Minimum value ⁽¹³⁾	Float [32]	C390 - C391	Depends on the selected variable	-
Connection delay	Uint [16]	C392	0... 65499 s	0 s
High level pulse width ⁽¹⁴⁾			0... 999 ms (x10)	
Disconnection delay	Uint [16]	C393	0... 65499 s	0 s
Low level pulse width ⁽¹⁴⁾			0... 999 ms (x10)	
Hysteresis	Uint [16]	C394	0... 99%	0%
Contact status	Uint [16]	C38D	0: Normally open - 1: Normally closed	0
Latch	Bool	C395	0: No - 1: Yes	
Latching time	Uint [16]	C396	0... 65499 s	0 s
Output unlocking ⁽¹¹⁾	Bool	C6AC	0	0
Manual Operation: Output status ⁽¹¹⁾ ⁽¹²⁾	Bool	C6B5	ON (Connect output): FF00 OFF (Disconnect output): 0000	0
SLOT 2				
Relay output 1				
Variable	Uint [16]	C738	0: Manual - Table 9 - Table 10 - Table 11 - Table 12	0
Maximum value ⁽¹³⁾ / Energy per pulse ⁽¹⁴⁾	Float [32]	C73A-C73B	Depends on the selected variable	-

Table 18 (Continuation): Modbus Memory Map: Relay outputs.

Configuration parameters	Format	Address	Valid data range	Default value
Minimum value ⁽¹³⁾	Float [32]	C73C-C73D	Depends on the selected variable	-
Connection delay	Uint [16]	C73E	0... 65499 s	0 s
High level pulse width ⁽¹⁴⁾			0... 999 ms (x10)	
Disconnection delay	Uint [16]	C73F	0... 65499 s	0 s
Low level pulse width ⁽¹⁴⁾			0... 999 ms (x10)	
Hysteresis	Uint [16]	C740	0... 99%	0%
Contact status	Uint [16]	C739	0: Normally open - 1: Normally closed	0
Latch	Bool	C741	0: No - 1: Yes	
Latching time	Uint [16]	C742	0... 65499 s	0 s
Output unlocking ⁽¹¹⁾	Bool	CA58	0	0
Manual Operation: Output status ⁽¹¹⁾ ⁽¹²⁾	Bool	CA61	ON (Connect output): FF00 OFF (Disconnect output): 0000	0
Relay output 2				
Variable	Uint [16]	C74C	0: Manual - Table 9 - Table 10 - Table 11 - Table 12	0
Maximum value ⁽¹³⁾ / Energy per pulse ⁽¹⁴⁾	Float [32]	C74E-C74F	Depends on the selected variable	-
Minimum value ⁽¹³⁾	Float [32]	C750-C751	Depends on the selected variable	-
Connection delay	Uint [16]	C752	0... 65499 s	0 s
High level pulse width ⁽¹⁴⁾			0... 999 ms (x10)	
Disconnection delay	Uint [16]	C753	0... 65499 s	0 s
Low level pulse width ⁽¹⁴⁾			0... 999 ms (x10)	
Hysteresis	Uint [16]	C754	0... 99%	0%
Contact status	Uint [16]	C74D	0: Normally open - 1: Normally closed	0
Latch	Bool	C755	0: No - 1: Yes	
Latching time	Uint [16]	C756	0... 65499 s	0 s
Output unlocking ⁽¹¹⁾	Bool	CA6C	0	0
Manual Operation: Output status ⁽¹¹⁾ ⁽¹²⁾	Bool	CA75	ON (Connect output): FF00 OFF (Disconnect output): 0000	0
Relay output 3				
Variable	Uint [16]	C760	0: Manual - Table 9 - Table 10 - Table 11 - Table 12	0
Maximum value ⁽¹³⁾ / Energy per pulse ⁽¹⁴⁾	Float [32]	C762-C763	Depends on the selected variable	-
Minimum value ⁽¹³⁾	Float [32]	C764-C765	Depends on the selected variable	-
Connection delay	Uint [16]	C766	0... 65499 s	0 s
High level pulse width ⁽¹⁴⁾			0... 999 ms (x10)	
Disconnection delay ⁽¹⁴⁾	Uint [16]	C767	0... 65499 s	0 s
Low level pulse width			0... 999 ms (x10)	
Hysteresis	Uint [16]	C768	0... 99%	0%
Contact status	Uint [16]	C761	0: Normally open - 1: Normally closed	0
Latch	Bool	C769	0: No - 1: Yes	

Table 18 (Continuation): Modbus Memory Map: Relay outputs.

Configuration parameters	Format	Address	Valid data range	Default value
Latching time	Uint [16]	C76A	0... 65499 s	0 s
Output unlocking ⁽¹¹⁾	Bool	CA80	0	0
Manual Operation: Output status ⁽¹¹⁾ ⁽¹²⁾	Bool	CA89	ON (Connect output): FF00 OFF (Disconnect output): 0000	0
Relay output 4				
Variable	Uint [16]	C774	0: Manual - Table 9 - Table 10 - Table 11 - Table 12	0
Maximum value ⁽¹³⁾ / Energy per pulse ⁽¹⁴⁾	Float [32]	C776-C777	Depends on the selected variable	-
Minimum value ⁽¹³⁾	Float [32]	C778-C779	Depends on the selected variable	-
Connection delay	Uint [16]	C77A	0... 65499 s	0 s
High level pulse width ⁽¹⁴⁾			0... 999 ms (x10)	
Disconnection delay	Uint [16]	C77B	0... 65499 s	0 s
Low level pulse width ⁽¹⁴⁾			0... 999 ms (x10)	
Hysteresis	Uint [16]	C77C	0... 99%	0%
Contact status	Uint [16]	C775	0: Normally open - 1: Normally closed	0
Latch	Bool	C77D	0: No - 1: Yes	
Latching time	Uint [16]	C77E	0... 65499 s	0 s
Output unlocking ⁽¹¹⁾	Bool	CA94	0	0
Manual Operation: Output status ⁽¹¹⁾ ⁽¹²⁾	Bool	CA9D	ON (Connect output): FF00 OFF (Disconnect output): 0000	0

⁽¹¹⁾ Functions 0x01 and 0x05 are used and for this variable.

⁽¹²⁾ Parameters to be configured if the parameter **Variable** has been selected as **Manual**.

⁽¹³⁾ Parameters to be configured if the parameter **Variable** has been selected from those in **Table 9 - Table 10 - Table 11**.

⁽¹⁴⁾ Parameters to be configured if the parameter **Variable** has been selected in **Table 12**.

4.6.- TECHNICAL FEATURES: line-M-4IO-R

General features	
Maximum power of the module	3 W
Installation category	CAT III 300V
Refresh time ⁽¹⁵⁾	200 ms
Response time (outputs)/Detection time (inputs) ⁽¹⁵⁾	< 200 ms



⁽¹⁵⁾ With the module connected to a line-CVM.

Digital inputs	
Quantity	4
Type	Optocoupled
Insulation	3750 V ~
Input impedance	3 kΩ

Digital relay outputs	
Quantity	4
Type	Electronic class A - High Frequency Current Filtering
Maximum switching voltage	250 V ~
Maximum instantaneous current	6 A ~
Maximum switching power	1500 VA
Electrical life (maximum load)	5x10 ⁴ cycles
Mechanical life	5x10 ⁶ cycles
Protection	Contacts protected by varistor (Maximum voltage: 275 V~)

User interface	
LED	9 LEDs

Environmental features	
Operating temperature	-10°C ... + 50°C
Storage temperature	-20°C ... +70°C
Relative humidity (non-condensing)	5... 95%
Maximum altitude	2000 m
Protection degree	IP30, Front: IP40,

Mechanical features			
Terminals			
1... 12, 19... 24	2.5 mm ²	≤ 0.4 Nm, M2.5	flat
Dimensions	Figure 12 (mm)		
Weight	175 g.		
Enclosure	Self-extinguishing V0 plastic		
Attachment	DIN rail ⁽¹⁶⁾		

⁽¹⁶⁾ Recommended minimum distance between DIN rails: 150 mm

Standards	
Safety requirements for electrical equipment for measurement, control, and laboratory use Part 1: General requirements.	EN 61010-1
Electromagnetic compatibility (EMC) Part 6-2: General standards. Immunity for industrial environments.	EN 61000-6-2
Electromagnetic Compatibility (EMC) Part 6-4: General standards. Emission standard for industrial environments. (IEC 61000-6-4: 2006).	EN 61000-6-4

(Continuation) Standards

Safety Requirements for Electrical Equipment for Measurement, Control, and Laboratory Use - Part 1: General Requirements

UL 61010-1

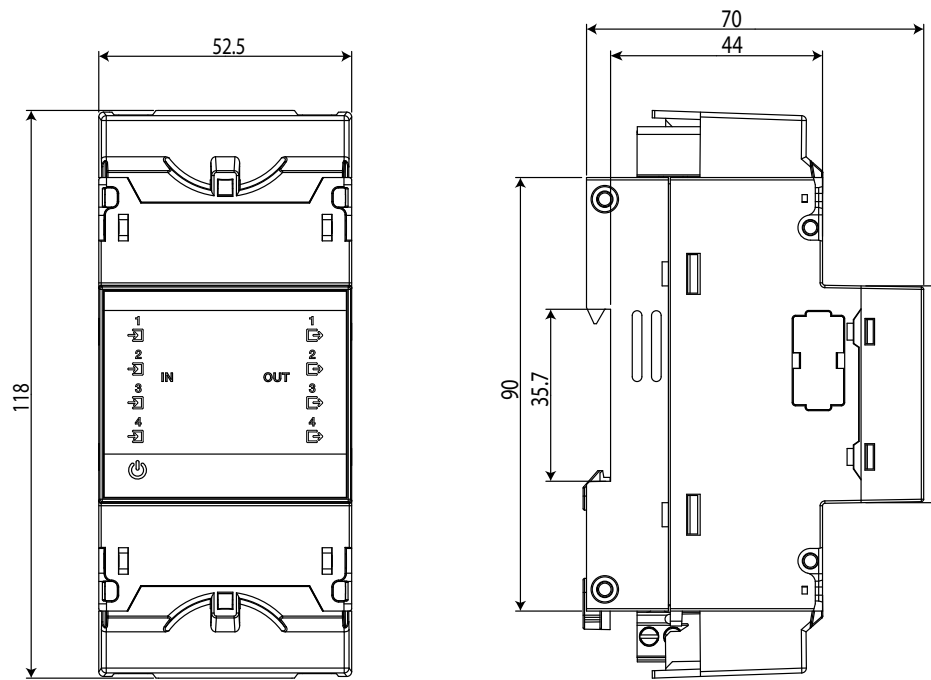

Figure 12: Line-M dimensions.

5.- line-M-410-T

The line-M-410-T expansion module has 4 digital inputs and 4 transistor outputs.



5.1.- DEVICE TERMINALS

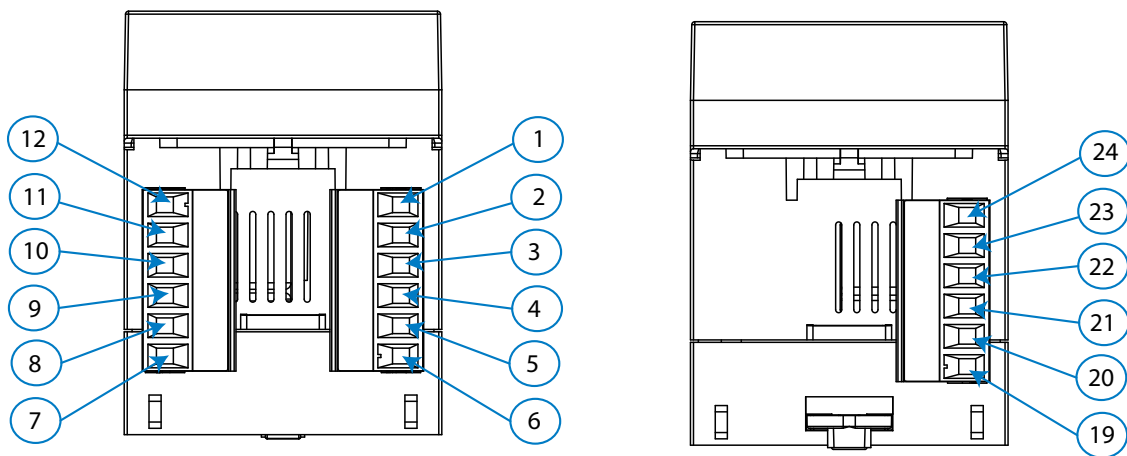

Figure 13: Line-M-410-T terminals: Upper - Lower.

Table 19: List of line-M-410-T terminals.

Device terminals	
1: C, Common digital inputs	10: NO, Transistor output 1 (NO)
2: 1, Digital input 1	11: C, Transistor output 1 (Common)
3: 2, Digital input 2	12: NC, Transistor output 1 (NC)
4: 3, Digital input 3	19: NO, Transistor output 4 (NO)
5: 4, Digital input 4	20: C, Transistor output 4 (Common)
6: Vcc, + 12V	21: NC, Transistor output 4 (NC)
7: NO, Transistor output 2 (NO)	22: NO, Transistor output 3 (NO)
8: C, Transistor output 2 (Common)	23: C, Transistor output 3 (Common)
9: NC, Transistor output 2 (NC)	24: NC, Transistor output 3 (NC)

5.2. - CONNECTION DIAGRAM

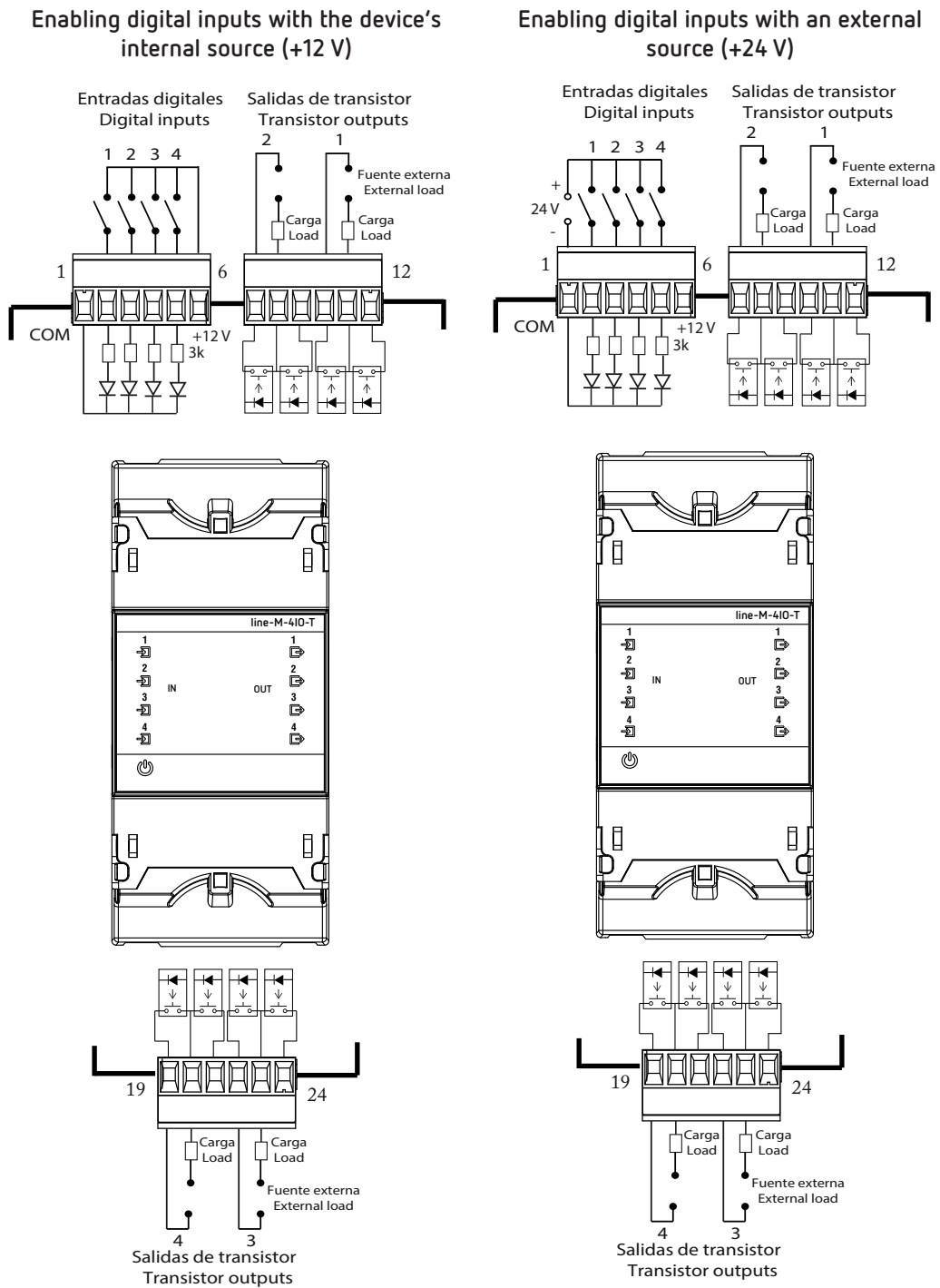

Figure 14: Line-M-410-T connection diagram.

5.3 .- LED INDICATORS

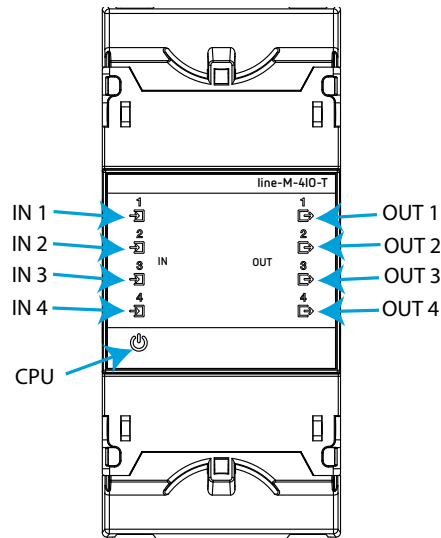

Figure 15: LEDs: line-M-4IO-T.

The **line-M-4IO-T** expansion module have 9 indicating LEDs:

✓ **CPU**, Indicates device status:

Table 20: CPU LED.

LED	Description
CPU	Flashing:
	<i>White</i> : Indicates that the device is powered

✓ **IN x**, Indicates digital input x status:

Table 21: Led IN x.

LED	Description
IN x	On:
	<i>Green</i> : Indicates activated input

✓ **OUT x**, Indicates relay output x status:

Table 22: LED OUT x.

LED	Description
OUT x	On:
	<i>Red</i> : Indicates activated transistor output.

5.4.- CONFIGURATION line-M-4IO-T

Configuration via display of the **line-M-4IO-T** expansion module is carried out via **line-CVM** to which it is connected.

To access the configuration menu, hold down (>2s) key .

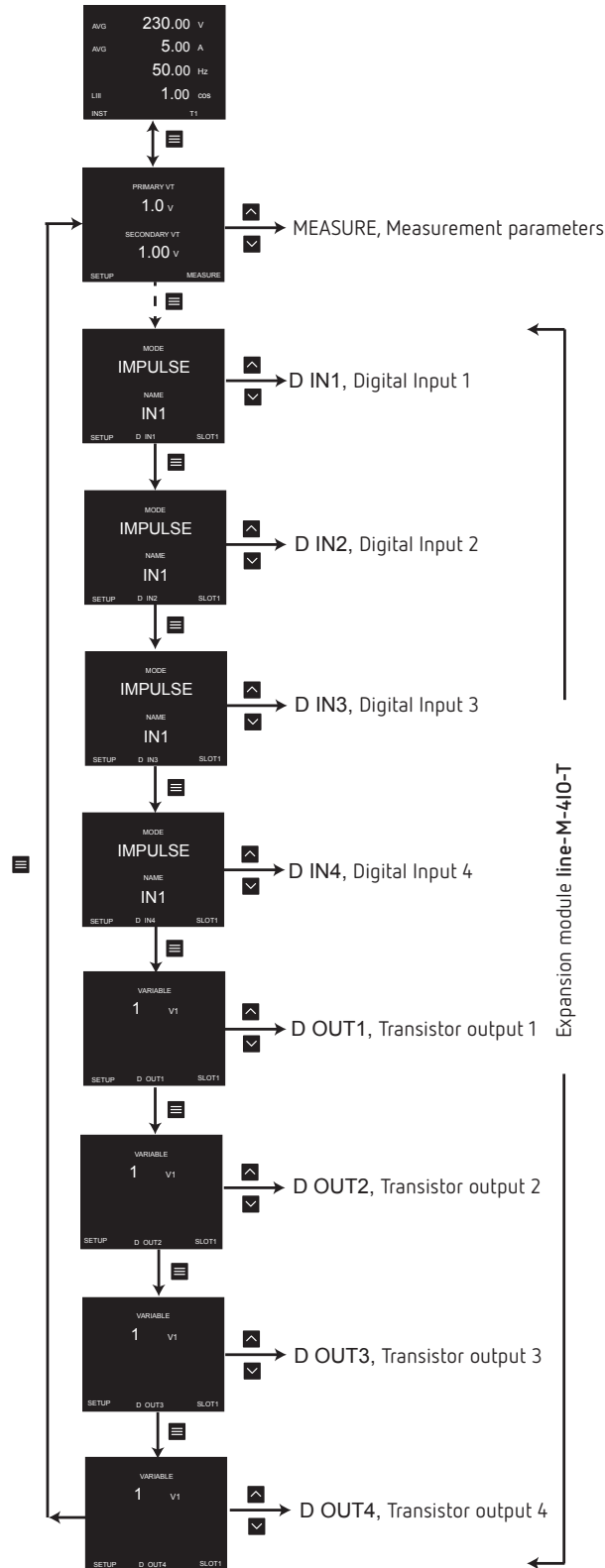

Figure 16: Configuration menu.

Note: SLOT1 is the expansion module nearest **line-CVM**, SLOT2 is the following expansion module.

To exit the configuration menu, hold down (>2s) key .

5.4.1.- CONFIGURATION OF DIGITAL INPUTS 1 ... 4

Note: Digital input *x* configuration is identified by the literal **D IN_x** at the bottom centre of the display.

See Digital Input Configuration in section "4.4.1.- CONFIGURATION OF DIGITAL INPUTS 1 ... 4."

5.4.2.- CONFIGURATION OF TRANSISTOR OUTPUTS 1 ... 4

Note: Transistor output *x* configuration is identified by the literal **D OUT_x** at the bottom centre of the display.

Transistor output configuration is the same as relay output configuration, see "4.4.2.- CONFIGURATION OF RELAY OUTPUTS 1 ... 4."

5.5.- MODBUS MEMORY MAP line-M-4IO-T

Note: For all modbus map parameters, SLOT1 corresponds to the first expansion module connected to the right-hand side of the **line-CVM-D** and SLOT2 corresponds to the second connected module.

5.5.1.- INPUT AND OUTPUT STATUS

See input and output status addresses in section "4.5.1.- INPUT AND OUTPUT STATUS"

5.5.2.- PULSE METERS

See input and output status addresses in section "4.5.2.- IMPULSE METERS"

5.5.3.- ALARMS

See alarm activation date addresses in section "4.5.3.- ALARMS"

5.5.4.- DEVICE CONFIGURATION VARIABLES

5.5.4.1.- Digital Input Configuration

See Digital Input Configuration Addresses in section "4.5.4.1.- Digital Input Configuration"

5.5.4.2.- Transistor Output Configuration

Transistor output configuration addresses are the same as those for relay outputs, see section "4.5.4.2.- Relay Output Configuration".

5.6.- TECHNICAL FEATURES: line-M-4IO-T

General features	
Maximum power of the module	3 W
Installation category	CAT III 300V
Refresh time ⁽¹⁷⁾	200 ms
Response time (outputs)/Detection time (inputs) ⁽¹⁷⁾	< 200 ms



⁽¹⁷⁾ With the module connected to a line-CVM.

Digital inputs	
Quantity	4
Type	Optocoupled
Insulation	3750 V ~
Input impedance	3 kΩ

Digital transistor outputs	
Quantity	4
Type	Optocoupled (Open-Collector)
Maximum voltage	48 V ---
Maximum current	120 mA
Maximum frequency	500 Hz
Pulse width	1 ms

User interface	
LED	9 LEDs

Environmental features	
Operating temperature	-10°C ... + 50°C
Storage temperature	-20°C ... +70°C
Relative humidity (non-condensing)	5... 95%
Maximum altitude	2000 m
Protection degree	IP30, Front: IP40,

Mechanical features			
Terminals			
1... 12, 19... 24	2.5 mm ²	≤ 0.4 Nm, M2.5	flat
Dimensions	Figure 12 (mm)		
Weight	155 g.		
Enclosure	Self-extinguishing V0 plastic		
Attachment	DIN rail ⁽¹⁸⁾		

⁽¹⁸⁾ Recommended minimum distance between DIN rails: 150 mm

Standards	
Safety requirements for electrical equipment for measurement, control, and laboratory use Part 1: General requirements.	En 61010-1
Electromagnetic compatibility (EMC) Part 6-2: General standards. Immunity for industrial environments.	EN 61000-6-2
Electromagnetic Compatibility (EMC) Part 6-4: General standards. Emission standard for industrial environments. (IEC 61000-6-4: 2006).	EN 61000-6-4
Safety Requirements for Electrical Equipment for Measurement, Control, and Laboratory Use - Part 1: General Requirements	UL 61010-1

6.- line-M-4IO-A

The line-M-4IO-A expansion module has 4 analogue inputs and outputs.



6.1.- DEVICE TERMINALS

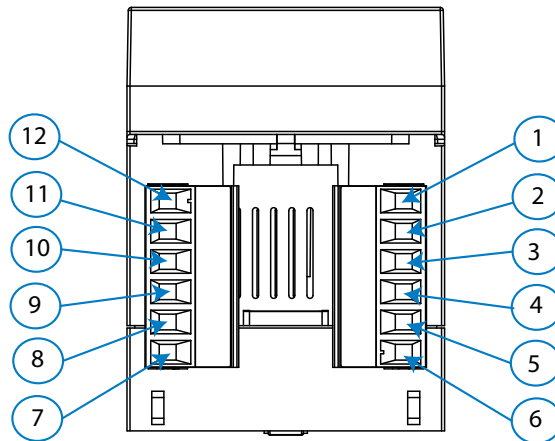

Figure 17: Line-M-4IO-A terminals: Upper - Lower.

Table 23: List of line-M-4IO-A terminals.

Device terminals	
1: 1, Analogue input 1	7, 8: GND, Common analogue outputs
2: 2, Analogue input 2	9: 4, Analogue output 4
3: 3, Analogue input 3	10: 3, Analogue output 3
4: 4, Analogue input 4	11: 2, Analogue output 2
5, 6: GND, Common analogue inputs	12: 1, Analogue output 1

6.2. - CONNECTION DIAGRAM

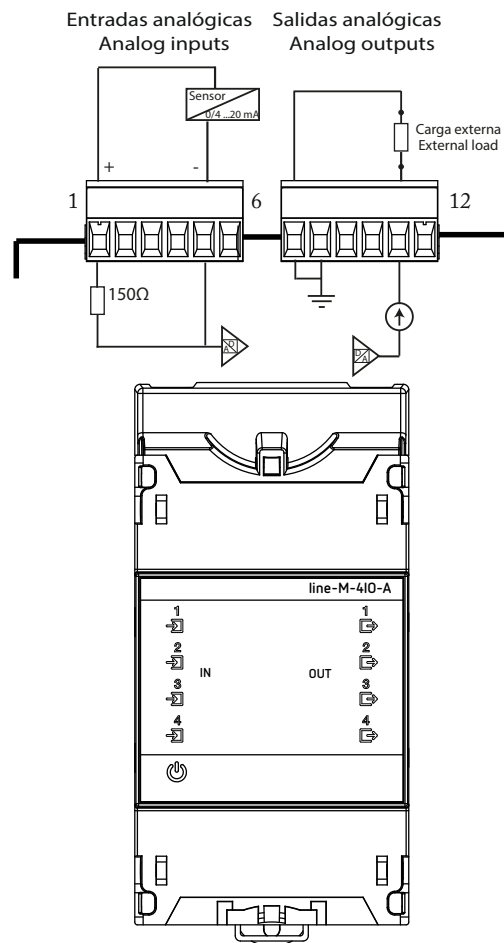

Figure 18: Line-M-4IO-A connection diagram.

6.3. - LED INDICATORS

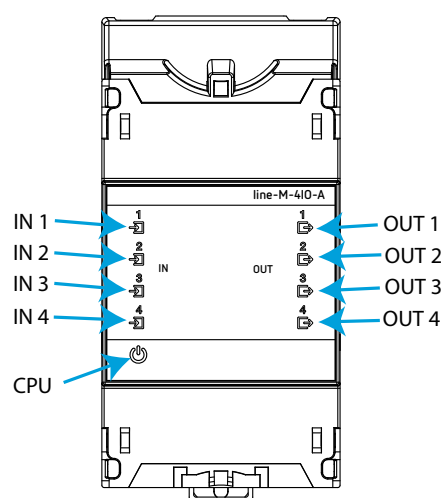

Figure 19: LEDs: line-M-4IO-A.

The **line-M-4IO-A** have 9 indicating LEDs:

✓ CPU, Indicates device status:

Table 24: CPU LED.

LED	Description
CPU	Flashing:
	<i>White</i> : Indicates that the device is powered

✓ IN x, Indicates analogue input x status:

Table 25: Led IN x.

LED	Description
IN x	On:
	<i>Green</i> : Indicates activated x input

✓ OUT x, Indicates analogue output x status:

Table 26: LED OUT x.

LED	Description
OUT x	On:
	<i>Red</i> : Indicates activated x output

6.4.- CONFIGURATION Line-M-410-A

Configuration via display of the **line-M-410-A** is carried out via **line-CVM** to which it is connected. To access the configuration menu, hold down (>2s) key .

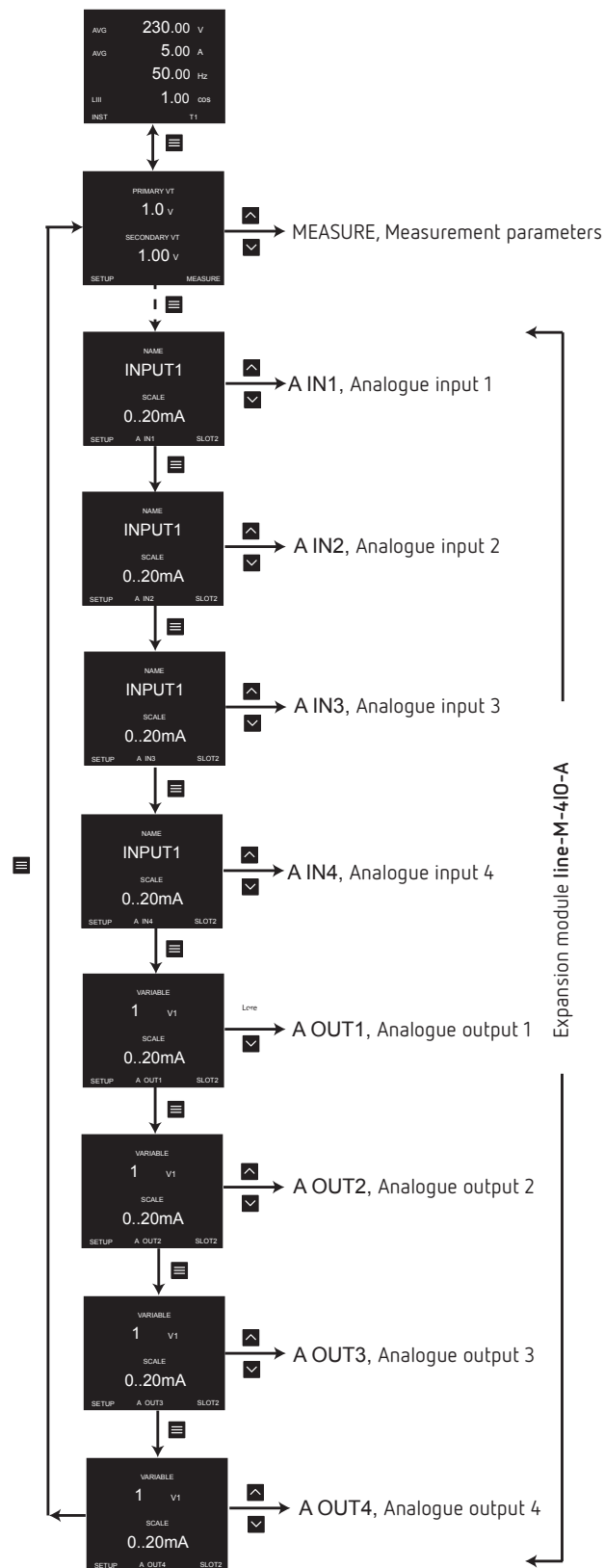



Figure 20: Configuration menu.

Note: SLOT1 is the expansion module nearest line-CVM, SLOT2 is the following expansion module.

To exit the configuration menu, hold down (>2s) key .

6.4.1.- CONFIGURATION OF ANALOGUE INPUTS 1 ... 4



Note: Analogue input x configuration is identified by the literal **A IN x** at the bottom centre of the display.

6.4.1.1 .- Analogue input x Name and Scale

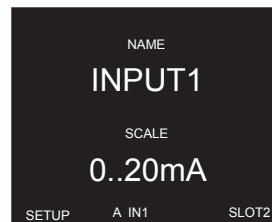
This screen enables the name of analogue input X and its scale to be configured.



Hold down key  to set **input name (NAME)**.

Use keys  and  to modify the digit's value.

Press key  to skip through the digits.

Hold down key  to set the **scale (SCALE)**.

Use keys  and  to skip through the different options:

0..20 mA, Analogue input scale 0.. 20 mA.

4.. 20 mA, Analogue input scale 4 .. 20 mA.

To validate the option, hold down key .

Use key  to skip to the next programming point.

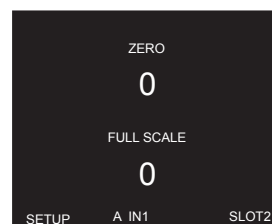

6.4.1.2.- Zero and Full Scale

This screen enables configuration of the analogue input's Zero and Full Scale.



Hold down key  to set **zero (ZERO)**, whose initial analogue input value is 0 or 4 mA.

Hold down key  to set **full scale (FULL SCALE)**, whose final analogue input value is 20 mA.

Use keys  and  to modify the digit's value.

Press key  to skip through the digits.

✓ **Zero and Full Scale:**

Minimum value: - 32765.

Maximum value: 32765.

Hold down key  to validate the value.

Use key  to skip to the next programming point.

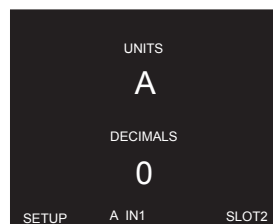

6.4.1.3.- Units and decimal No.

This screen enables configuration of the analogue input's units and number of decimals.



Hold down key  to set the **Units (UNITS)** for the analogue input.

Hold down key  to set **the number of decimals (DECIMALS)** for the analogue input.

Use keys  and  to modify the digit's value.

Press key  to skip through the digits.

✓ **No. of decimals:**

Minimum value: 0.

Maximum value: 5.

Hold down key  to validate the value.

Use key  to skip to the next programming point.

6.4.2.- CONFIGURATION OF ANALOGUE OUTPUTS 1 ... 4



Note: Analogue output x configuration is identified by the literal **A OUT x** at the bottom centre of the display.

6.4.2.1.- Variable and Scale

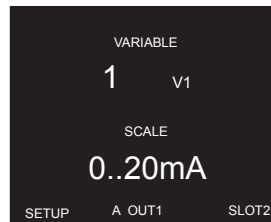
This screen enables the analogue output's Variable and Scale to be configured.



Hold down key  to select the **analogue output's variable (VARIABLE)**.

Use keys  and  to modify the digit's value.

Press key  to skip through the digits.

The codes for the variables are shown in **Table 9**, **Table 11** and **Table 12**.

To validate the option, hold down key .

Hold down key  to set the **scale (SCALE)**.

Use keys  and  to skip through the different options:

0..20 mA, Analogue output scale 0.. 20 mA.

0.. 10 V, Analogue output scale 0.. 10 V.

4.. 20 mA, Analogue output scale 4 .. 20 mA.

To validate the option, hold down key .

Use key  to skip to the next programming point.

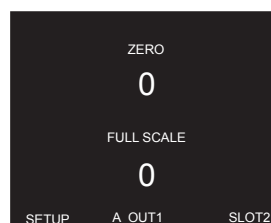

6.4.2.2.- Zero and Full Scale

This screen enables configuration of the analogue output's Zero and Full Scale.



Hold down key  to set **zero (ZERO)**, whose initial analogue output value is 0 mA, 4 mA or 0 V.

Hold down key  to set **full scale (FULL SCALE)**, whose final analogue output value is 20 mA or 10 V.

Use keys  and  to modify the digit's value.

Press key  to skip through the digits.

✓ **Zero and Full Scale:**

Minimum value: - 32765.

Maximum value: 32765.

Hold down key  to validate the value.

Use key  to skip to the next programming point.

6.5.- MODBUS MEMORY MAP line-M-410-A

Note: For all modbus map parameters, SLOT1 corresponds to the first expansion module connected to the right-hand side of the **line-CVM-D** and SLOT2 corresponds to the second connected module.

6.5.1.- ANALOGUE INPUT

The **Function 0x04**, is implemented for these variables.

Table 27: Modbus Memory Map: Analogue Input Value.

Parameter	Format	Address	
		SLOT 1	SLOT 2
Analogue Input Value 1	Int [32]	D390 - D391	D778 - D779
Analogue Input Value 2	Int [32]	D392 - D393	D77A - D77B
Analogue Input Value 3	Int [32]	D394 - D395	D77C - D77D
Analogue Input Value 4	Int [32]	D396 - D397	D77E - D77F

6.5.2.- DEVICE CONFIGURATION VARIABLES

The following functions are used for these variables:

Function 0x03: register readout.

Function 0x10: Writing multiple registers.

6.5.2.1.- Analogue Input Configuration

Table 28: Modbus Memory Map: Analogue Inputs.

SLOT 1				
Analogue Input 1				
Parameter	Format	Address	Valid data range	Default value
Name	String	D2F4 - D2F5 - D2F6 - D2F7	-	-
Scale	Uint [16]	D2F2	0: 0... 20 mA - 1: 4... 20 mA	0
Zero Value	Int [16]	D2F0	- 32765... 32765	0
Full Scale Value	Int [16]	D2F1	- 32765... 32765	0
Units	String	D2F8 - D2F9 -D2FA	-	-
N° of Decimals	Uint [16]	D2F3	0... 5	0
Analogue Input 2				
Name	String	D308-D309 - D30A-D30B	-	-
Scale	Uint [16]	D306	0: 0... 20 mA - 1: 4... 20 mA	0
Zero Value	Int [16]	D304	- 32765... 32765	0
Full Scale Value	Int [16]	D305	- 32765... 32765	0
Units	String	D30C- D30D - D30E	-	-
N° of Decimals	Uint [16]	D307	0... 5	0
Analogue Input 3				
Name	String	D31C - D31D - D31E - D31F	-	-
Scale	Uint [16]	D31A	0: 0... 20 mA - 1: 4... 20 mA	0
Zero Value	Int [16]	D318	- 32765... 32765	0
Full Scale Value	Int [16]	D319	- 32765... 32765	0
Units	String	D320- D321 - D322	-	-
N° of Decimals	Uint [16]	D31B	0... 5	0
Analogue Input 4				
Name	String	D330-D331 - D332-D333	-	-
Scale	Uint [16]	D32E	0: 0... 20 mA - 1: 4... 20 mA	0
Zero Value	Int [16]	D32C	- 32765... 32765	0
Full Scale Value	Int [16]	D32D	- 32765... 32765	0
Units	String	D334- D335 - D336	-	-
N° of Decimals	Uint [16]	D32F	0... 5	0
SLOT 2				
Analogue Input 1				
Name	String	D6DC-D6DD - D6DE-D6DF	-	-
Scale	Uint [16]	D6DA	0: 0... 20 mA - 1: 4... 20 mA	0
Zero Value	Int [16]	D6D8	- 32765... 32765	0
Full Scale Value	Int [16]	D6D9	- 32765... 32765	0
Units	String	D6E0-D6E1-D6E2	-	-
N° of Decimals	Uint [16]	D6DB	0... 5	0

Table 28 (Continuation): Modbus Memory Map: Analogue Inputs.

Parameter	Format	Address	Valid data range	Default value
Analogue Input 2				
Name	String	D6F0-D6F1-D6F2-D6F3	-	-
Scale	Uint [16]	D6EE	0: 0... 20 mA - 1: 4... 20 mA	0
Zero Value	Int [16]	D6EC	- 32765... 32765	0
Full Scale Value	Int [16]	D6ED	- 32765... 32765	0
Units	String	D6F4-D6F5 -D6F6	-	-
N° of Decimals	Uint [16]	D6EF	0... 5	0
Analogue Input 3				
Name	String	D704 - D705 - D706 - D707	-	-
Scale	Uint [16]	D702	0: 0... 20 mA - 1: 4... 20 mA	0
Zero Value	Int [16]	D700	- 32765... 32765	0
Full Scale Value	Int [16]	D701	- 32765... 32765	0
Units	String	D708-D709-D70A	-	-
N° of Decimals	Uint [16]	D703	0... 5	0
Analogue Input 4				
Name	String	D718-D719 - D71A-D71B	-	-
Scale	Uint [16]	D716	0: 0... 20 mA - 1: 4... 20 mA	0
Zero Value	Int [16]	D714	- 32765... 32765	0
Full Scale Value	Int [16]	D715	- 32765... 32765	0
Units	String	D71C-D71D -D71E	-	-
N° of Decimals	Uint [16]	D717	0... 5	0

6.5.2.2.- Analogue Output Configuration

Table 29: Modbus Memory Map: Analogue outputs.

SLOT 1				
Analogue output 1				
Configuration parameters	Format	Address	Valid data range	Default value
Variable	Uint [16]	D340	Table 9 - Table 11 - Table 12	0
Scale	Uint [16]	D345	0: 0... 20 mA - 1: 4... 20 mA - 2: 0... 10 V	0
Zero Value	Int [32]	D341-D342	- 32765... 32765	0
Full Scale Value	Int [32]	D343-D344	- 32765... 32765	0
Analogue output 2				
Variable	Uint [16]	D34A	Table 9 - Table 11 - Table 12	0
Scale	Uint [16]	D34F	0: 0... 20 mA - 1: 4... 20 mA - 2: 0... 10 V	0
Zero Value	Int [32]	D34B-D34C	- 32765... 32765	0
Full Scale Value	Int [32]	D34D-D34E	- 32765... 32765	0
Analogue output 3				
Variable	Uint [16]	D354	Table 9 - Table 11 - Table 12	0

Table 29 (Continuation): Modbus Memory Map: Analogue outputs.

Configuration parameters	Format	Address	Valid data range	Default value
Scale	Uint [16]	D359	0: 0... 20 mA - 1: 4... 20 mA - 2: 0... 10 V	0
Zero Value	Int [32]	D355-D356	- 32765... 32765	0
Full Scale Value	Int [32]	D357-D358	- 32765... 32765	0
Analogue output 4				
Variable	Uint [16]	D35E	Table 9 - Table 11 - Table 12	0
Scale	Uint [16]	D363	0: 0... 20 mA - 1: 4... 20 mA - 2: 0... 10 V	0
Zero Value	Int [32]	D35F-D360	- 32765... 32765	0
Full Scale Value	Int [32]	D361-D362	- 32765... 32765	0
SLOT 2				
Analogue output 1				
Variable	Uint [16]	D728	Table 9 - Table 11 - Table 12	0
Scale	Uint [16]	D72D	0: 0... 20 mA - 1: 4... 20 mA - 2: 0... 10 V	0
Zero Value	Int [32]	D729-D72A	- 32765... 32765	0
Full Scale Value	Int [32]	D72B-D72C	- 32765... 32765	0
Analogue output 2				
Variable	Uint [16]	D732	Table 9 - Table 11 - Table 12	0
Scale	Uint [16]	D737	0: 0... 20 mA - 1: 4... 20 mA - 2: 0... 10 V	0
Zero Value	Int [32]	D733-D734	- 32765... 32765	0
Full Scale Value	Int [32]	D735-D736	- 32765... 32765	0
Analogue output 3				
Variable	Uint [16]	D73C	Table 9 - Table 11 - Table 12	0
Scale	Uint [16]	D741	0: 0... 20 mA - 1: 4... 20 mA - 2: 0... 10 V	0
Zero Value	Int [32]	D73D-D73E	- 32765... 32765	0
Full Scale Value	Int [32]	D73F-D740	- 32765... 32765	0
Analogue output 4				
Variable	Uint [16]	D746	Table 9 - Table 11 - Table 12	0
Scale	Uint [16]	D74B	0: 0... 20 mA - 1: 4... 20 mA - 2: 0... 10 V	0
Zero Value	Int [32]	D747-D748	- 32765... 32765	0
Full Scale Value	Int [32]	D749-D74A	- 32765... 32765	0

6.6.- TECHNICAL FEATURES: line-M-4IO-A

General features	
Maximum power of the module	3 W
Installation category	CAT III 300V
Refresh time ⁽¹⁹⁾	200 ms
Response time (outputs)/Detection time (inputs) ⁽¹⁹⁾	< 200 ms

⁽¹⁹⁾ With the module connected to a line-CVM.



Analogue inputs	
Quantity	4
Type of measure	Current
Nominal input range	0 - 20 mA, 4 - 20 mA (Programmable)
Input impedance	150 Ω
Permissible maximum current to the input	22 mA ---

Analogue outputs	
Quantity	4
Maximum internal voltage	12 V
Linearity	< 1%
DAC resolution	4096 points
Analogue outputs in current mode	
Nominal output range	0 - 20 mA, 4 - 20 mA (Programmable)
Maximum load resistance	300 Ω
Analogue outputs in voltage mode	
Nominal output range	0 - 10 V
Maximum load resistance	5000 Ω

Accuracy			
	Inputs	Outputs	
	0... 20 mA	0... 20 mA	0... 10 V
Accuracy	< 1 %	1%	1%
Accuracy range in relation to Full Scale	5... 100%	0,5... 100%	2... 100%
Measurement range in relation to Full Scale	1... 100%	0,1... 100%	0,2... 100%

User interface	
LED	9 LEDs

Environmental features	
Operating temperature	-10°C ... + 50°C
Storage temperature	-20°C ... +70°C
Relative humidity (non-condensing)	5... 95%
Maximum altitude	2000 m
Protection degree	IP30, Front: IP40,

Mechanical features			
Terminals			
1... 12,	2.5 mm ²	≤ 0.4 Nm, M2.5	flat
Dimensions	Figure 12 (mm)		
Weight	153 g.		

(Continuation) Mechanical features	
Enclosure	Self-extinguishing V0 plastic
Attachment	DIN rail ⁽²⁰⁾

⁽²⁰⁾ Recommended minimum distance between DIN rails: 150 mm.

Standards	
Safety requirements for electrical equipment for measurement, control, and laboratory use Part 1: General requirements.	En 61010-1
Electromagnetic compatibility (EMC) Part 6-2: General standards. Immunity for industrial environments.	EN 61000-6-2
Electromagnetic Compatibility (EMC) Part 6-4: General standards. Emission standard for industrial environments. (IEC 61000-6-4: 2006).	EN 61000-6-4
Safety Requirements for Electrical Equipment for Measurement, Control, and Laboratory Use - Part 1: General Requirements	UL 61010-1

7.- line-M-4IO-RV

The **line-M-4IO-RV** expansion module has 4 digital inputs in voltage at 230 V~ and 4 relay outputs.



7.1.- DEVICE TERMINALS

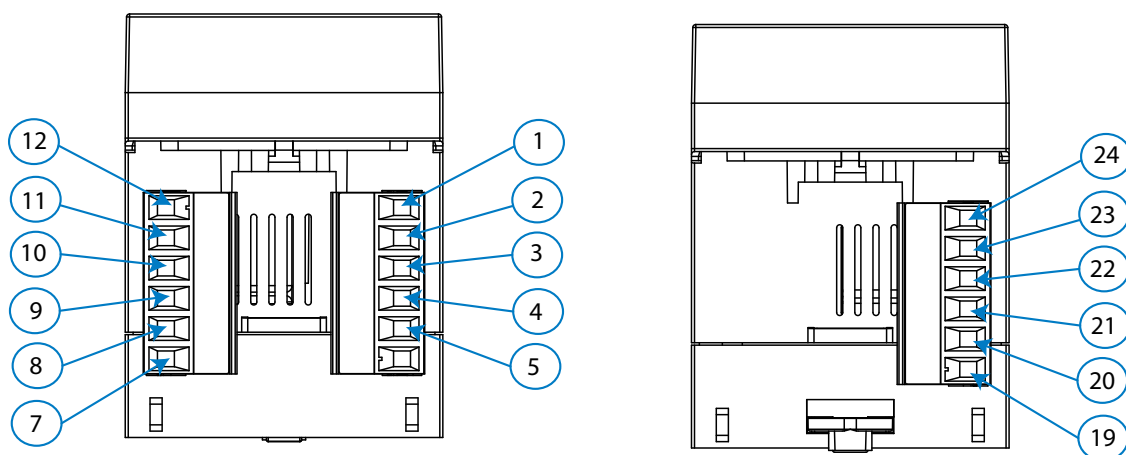

Figure 21: Line-M-4IO-RV terminals: Upper - Lower.

Table 30: List of line-M-4IO-RV terminals.

Device terminals	
1: C, Common digital inputs	11: C, Relay output 1 (Common)
2: 1, Digital input 1	12: NC, Relay output 1 (NC)
3: 2, Digital input 2	19: NO, Relay output 4 (NO)
4: 3, Digital input 3	20: C, Relay output 4 (Common)
5: 4, Digital input 4	21: NC, Relay output 4 (NC)
7: NO, Relay output 2 (NO)	22: NO, Relay output 3 (NO)
8: C, Relay output 2 (Common)	23: C, Relay output 3 (Common)
9: NC, Relay output 2 (NC)	24: NC, Relay output 3 (NC)
10: NO, Relay Output 1 (NO)	

7.2. - CONNECTION DIAGRAM

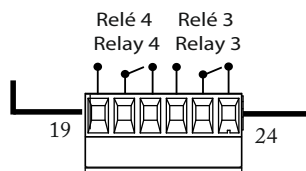
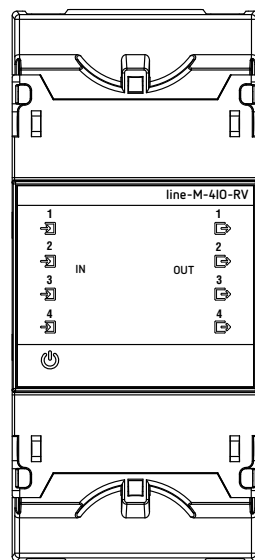
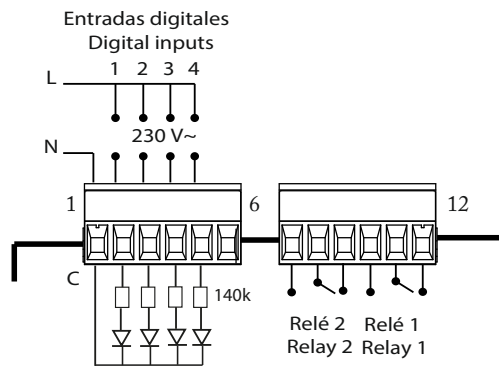

Figure 22: Line-M-4IO-RV connection diagram.

7.3 .- LED INDICATORS

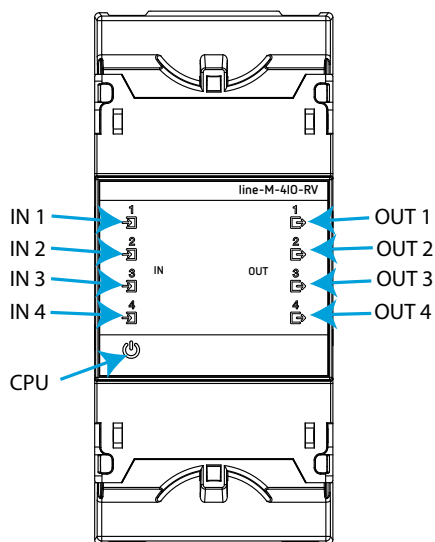

Figure 23: LEDs: line-M-410-RV.

The **line-M-410-RV** have 9 indicating LEDs:

✓ **CPU**, Indicates device status:

Table 31: CPU LED.

LED	Description
CPU	Flashing:
	<i>White</i> : Indicates that the device is powered

✓ **IN x**, Indicates digital input x status:

Table 32: Led IN x.

LED	Description
IN x	On:
	<i>Green</i> : Indicates activated input

✓ **OUT x**, Indicates relay output x status:

Table 33: LED OUT x.

LED	Description
OUT x	On:
	<i>Red</i> : Indicates activated x output

7.4.- CONFIGURATION line-M-4IO-RV

Configuration via display of the **line-M-4IO-RV** is carried out via **line-CVM** to which it is connected. To access the configuration menu, hold down (>2s) key .

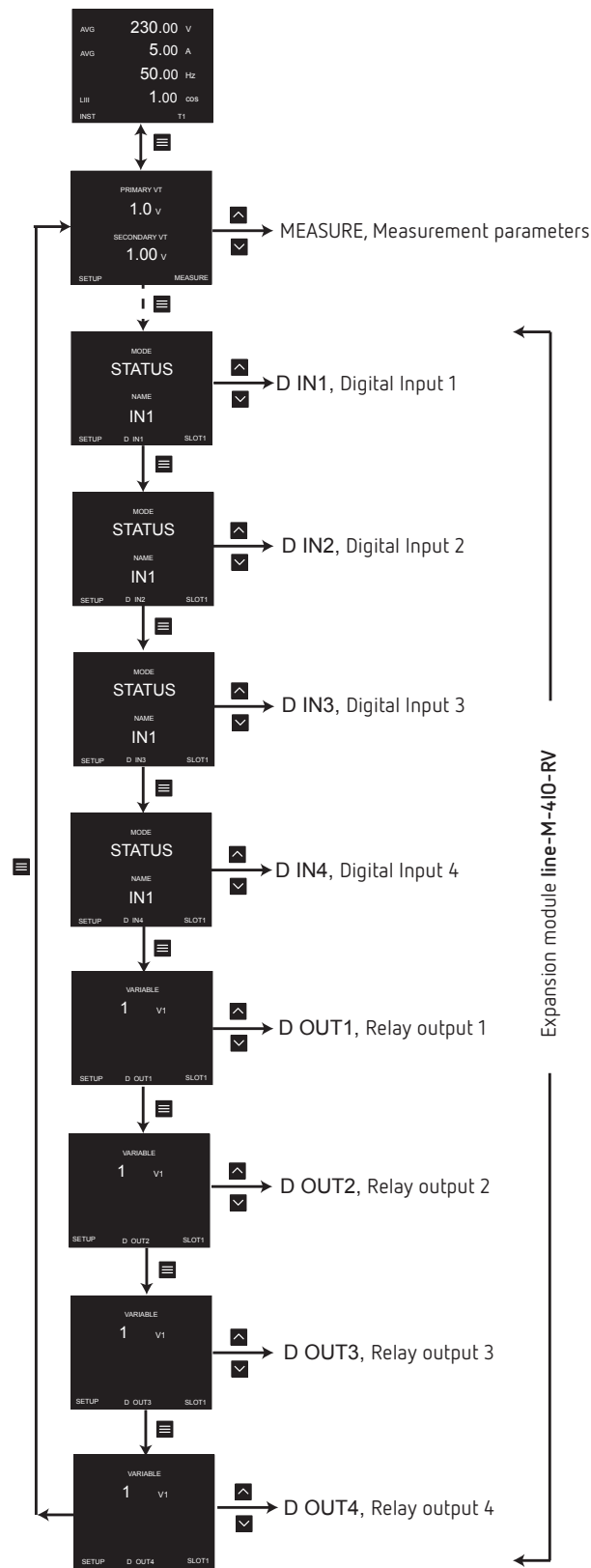



Figure 24: Configuration menu.

Note: *SLOT1 is the expansion module nearest line-CVM, SLOT2 is the following expansion module.*

To exit the configuration menu, hold down (>2s) key .

7.4.1.- CONFIGURATION OF DIGITAL INPUTS 1 ... 4

Note: *Digital input x configuration is identified by the literal **D INx** at the bottom centre of the display.*

See Digital Input Configuration in section "**4.4.1.- CONFIGURATION OF DIGITAL INPUTS 1 ... 4.**"

7.4.2.- CONFIGURATION OF RELAY OUTPUTS 1 ... 4

Note: *Relay output x configuration is identified by the literal **D OUTx** at the bottom centre of the display.*

See Relay Output Configuration in section "**4.4.2.- CONFIGURATION OF RELAY OUTPUTS 1 ... 4.**"

7.5.- MODBUS MEMORY MAP Line-M-410-RV

Note: *For all modbus map parameters, SLOT1 corresponds to the first expansion module connected to the right-hand side of the line-CVM-D and SLOT2 corresponds to the second connected module.*

7.5.1.- INPUT AND OUTPUT STATUS

See input and output status addresses in section "**4.5.1.- INPUT AND OUTPUT STATUS**"

7.5.2.- ALARMS

See alarm activation date addresses in section "**4.5.3.- ALARMS**"

7.5.3.- DEVICE CONFIGURATION VARIABLES

7.5.3.1.- Digital Input Configuration

See Digital Input Configuration Addresses in section "**4.5.4.1.- Digital Input Configuration**"

7.5.3.2.- Relay Output Configuration

See Relay Output Configuration Addresses in section "**4.5.4.2.- Relay Output Configuration**".

7.6.- TECHNICAL FEATURES: Line-M-410-RV

General features	
Maximum power of the module	2 W
Installation category	CAT III 300V
Refresh time ⁽²¹⁾	200 ms
Response time (outputs)/Detection time (inputs) ⁽²¹⁾	< 200 ms



⁽²¹⁾ With the module connected to a line-CVM.

Digital inputs	
Quantity	4
Type	Mains voltage input 230 V~
Maximum current	50 mA
Insulation	3750 V ~
Input impedance	140 kΩ

Digital relay outputs	
Quantity	4
Type	Electronic class A - High Frequency Current Filtering
Maximum switching voltage	250 V ~
Maximum instantaneous current	6 A ~
Maximum switching power	1500 VA
Electrical life (maximum load)	5x10 ⁴ cycles
Mechanical life	5x10 ⁶ cycles
Protection	Contacts protected by varistor (Maximum voltage: 275 V~)

User interface	
LED	9 LEDs

Environmental features	
Operating temperature	-10°C ... + 50°C
Storage temperature	-20°C ... +70°C
Relative humidity (non-condensing)	5... 95%
Maximum altitude	2000 m
Protection degree	IP30, Front: IP40,

Mechanical features			
Terminals			
1... 5, 7... 12, 19... 24	2.5 mm ²	≤ 0.4 Nm, M2.5	Flat
Dimensions	Figure 12 (mm)		
Weight	215 g.		
Enclosure	Self-extinguishing V0 plastic		
Attachment	DIN rail ⁽²²⁾		

⁽²²⁾ Recommended minimum distance between DIN rails: 150 mm.

Standards	
Safety requirements for electrical equipment for measurement, control, and laboratory use Part 1: General requirements.	EN 61010-1
Electromagnetic compatibility (EMC) Part 6-2: General standards. Immunity for industrial environments.	EN 61000-6-2
Electromagnetic Compatibility (EMC) Part 6-4: General standards. Emission standard for industrial environments. (IEC 61000-6-4: 2006).	EN 61000-6-4

(Continuation) Standards	
Safety Requirements for Electrical Equipment for Measurement, Control, and Laboratory Use - Part 1: General Requirements	UL 61010-1

8.- Line-M-EXT-PS

The Line-M-EXT-PS is a power adapter for the Line family of devices.



The module is connected to the left side of the device you wish to supply.

8.1.- INSTALLATION

The Line-M-EXT-PS connects to the left-hand side of the devices you wish to supply. It can supply up to 10 VA, allowing it to power a limited number of devices.

The maximum set it can supply is: 1 line-EDS 1 line-CVM + 1 line-M (Figure 25).

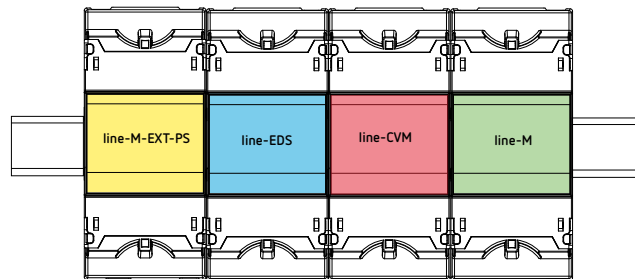

Figure 25: Maximum set a line-M-EXT-PS can supply.

Multiple Line-M-EXT-PS to supply sets with power above 10VA. Each Line-M-EXT-PS will power the devices connected to its right-hand side (Figure 26).

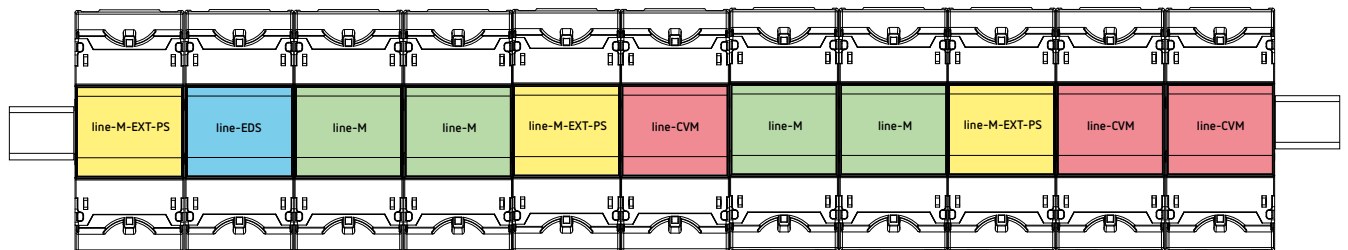

Figure 26: Multiple line-M-EXT-PS connection.

Note: The line-EDS and line-CVM devices, must not be connected to the auxiliary power supply.

8.2.- DEVICE TERMINALS

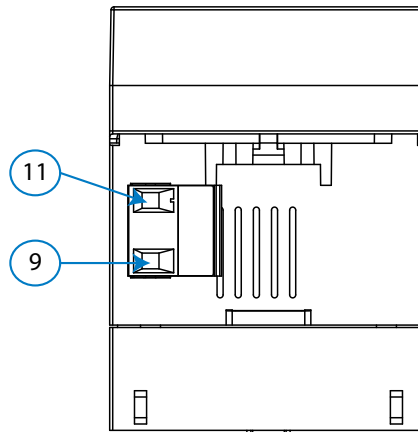

Figure 27: Line-M-EXT-PS terminals.

Table 34: List of line-M-EXT-PS terminals.

Device terminals
9: A1 ~ / + , Auxiliary power supply
11: A2 ~ / - , Auxiliary power supply

8.3.- CONNECTION DIAGRAM

8.3.1.- MAXIMUM CONNECTION

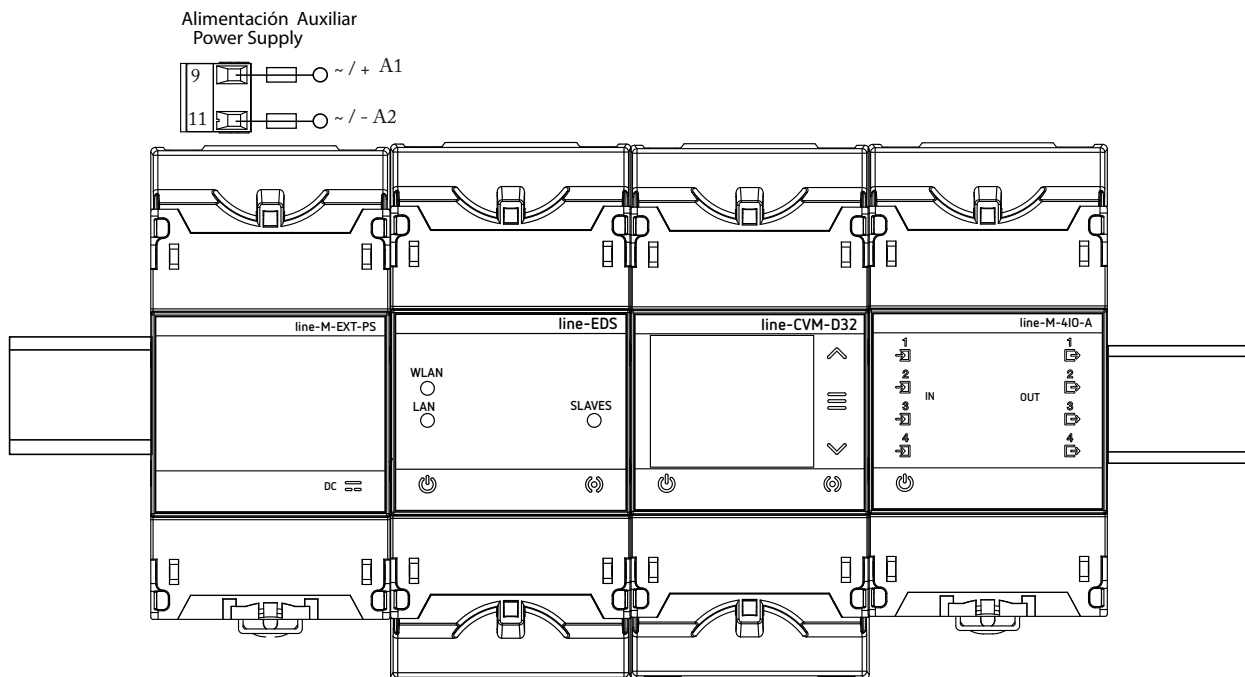

Figure 28: Maximum connection.

8.3.2.- MULTIPLE CONNECTION Line-M-EXT-PS

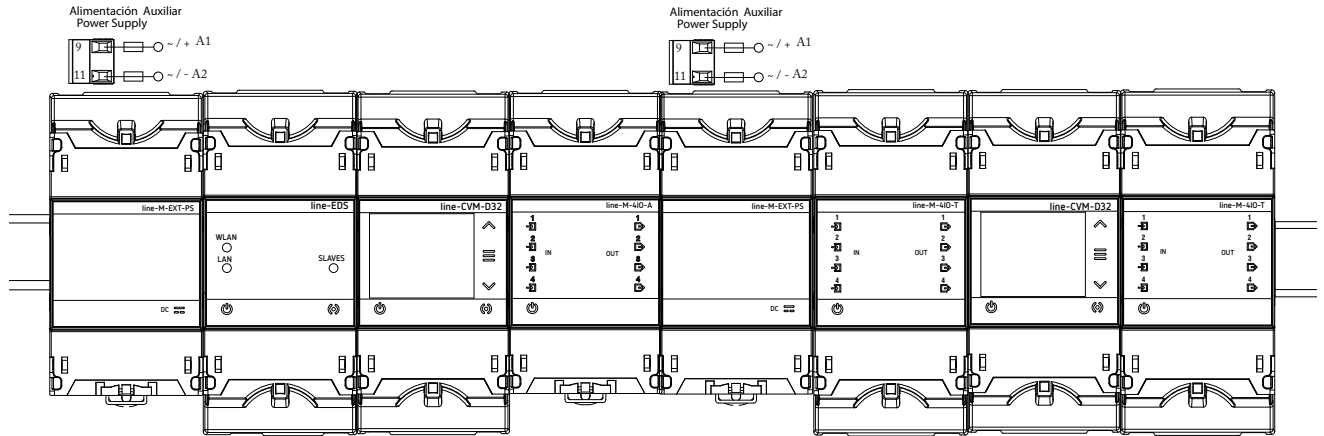

Figure 29: Multiple line-M-EXT-PS connection.

8.4. - LED INDICATORS

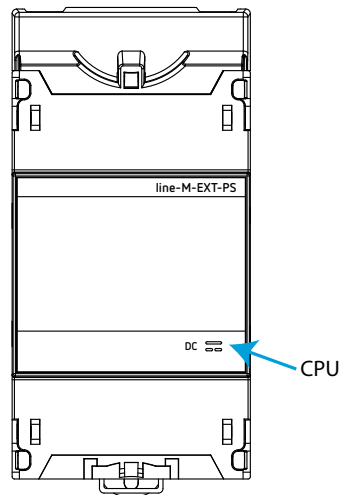

Figure 30: LEDs: line-M-EXT-PS.



The **Line-M-EXT-PS** have 1 indicating LED:

✓ **CPU**, Indicates device status:

Table 35: LEDs line-M-EXT-PS.

LED	Description
CPU	Flashing:
	<i>Green:</i> Indicates that the device is powered

8.5. - TECHNICAL FEATURES: Line-M-EXT-PS

Power supply			
Input			
AC power supply			
Rated voltage	110... 277 V~ (Ph - N) / 110 ... 480 V~ (Ph - Ph)		
Frequency	50... 60 Hz		
Consumption	1... 9 VA		
Installation category	CAT III 300V		
Output			
Maximum output voltage	12 V ===		
Maximum output current	0.9 A ===		
Maximum output power	10 VA		
User interface			
LED	1 LED		
Environmental features			
Operating temperature	-10°C ... + 50°C		
Storage temperature	-20°C ... +70°C		
Relative humidity (non-condensing)	5... 95%		
Maximum altitude	2000 m		
Protection degree	IP30, Front: IP40		
Mechanical features			
Terminals			
9, 11	2.5 mm ²	≤ 0.4 Nm, M2.5	flat
Dimensions	Figure 12 (mm)		
Weight	350 g.		
Enclosure	Self-extinguishing V0 plastic		
Attachment	DIN rail ⁽²³⁾		
Standards			
Safety requirements for electrical equipment for measurement, control, and laboratory use Part 1: General requirements.	EN 61010-1		
Safety requirements for electrical equipment for measurement, control, and laboratory use Part 2-030: Specific requirements for test and measuring circuits.	EN 61010-2-030		
Electrical material for measurement, control and laboratory use Electromagnetic compatibility (EMC) requirements Part 1: General requirements	EN 61326-1		
Electromagnetic compatibility of multimedia equipment. Emission requirements.	EN 55032		
	UL 94		
Audio/video, information and communication technology equipment. Part 1: Safety requirements	EN 62368-1		

⁽²³⁾ Recommended minimum distance between DIN rails: 150 mm.

9.- line-M-3G

The **line-M-3G** module adds 3G connectivity to the **line-EDS** device to which it is connected.



The module is connected laterally to the left of the **line-EDS** devices.

9.1.- INSTALLATION OF THE SIM CARD



Before installing the SIM card, the module must be disconnected from any power source.

The slot for inserting the SIM card is at the back of the device, **Figure 31**.

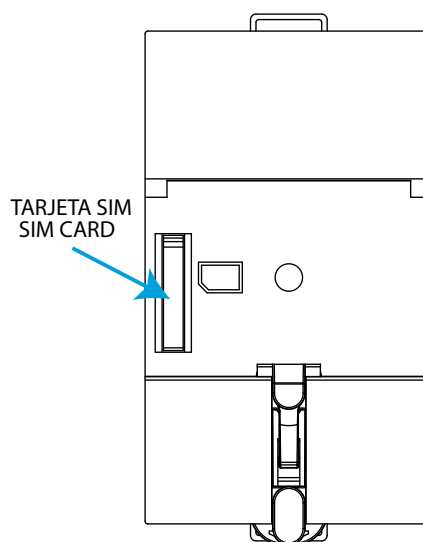

Figure 31: SIM card position.

9.2.- LED INDICATORS

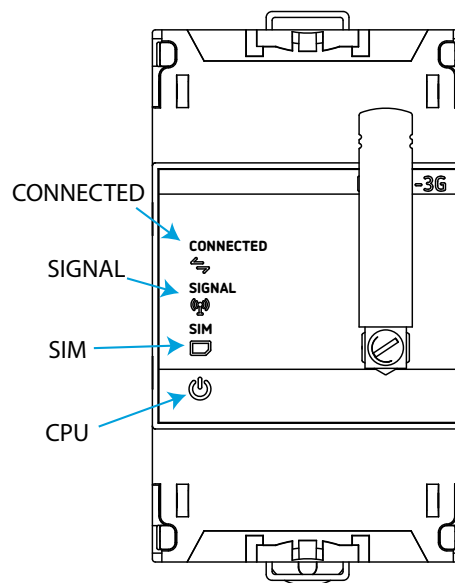

Figure 32: LEDs: line-M-3G.

The **line-M-3G** have 4 indicating LEDs:

✓ **CPU**, Indicates device status:

Table 36: LED CPU.

LED	Description
CPU	Flashing:
	<i>White</i> : Indicates that the device is powered

✓ **CONNECTED**, Indicates the connection status:

Table 37: LED CONNECTED.

LED	Description
CONNECTED	Flashing:
	<i>Blue color</i> : Indicates that connection has been made, has registered to the network

✓ **SIGNAL**, Indicates the 3G coverage:

Table 38: LED SIGNAL.

LED	Description
SIGNAL	On:
	<i>Blue color</i> : Indicates that 3G coverage is $\geq 25\%$

✓ **SIM**, Indicates the status of the SIM card:

Table 39: LED SIM.

LED	Description
SIM	On:
	<i>Red color</i> : Indicates that the device does not have the SIM card installed.

9.3.- COMMUNICATIONS

9.3.1.- USAGE ENVIRONMENT AND HEALTH

Wireless communications emit radio frequency electromagnetic energy, like other radio devices.

Because wireless communications operate under the guidelines found in radio frequency standards and recommendations, they are safe for users to use.

In some settings and situations the use of wireless communications may be restricted by the building's owner or representatives of the organisation.

These may include:

- ✓ Use of wireless connections on board aircraft, in hospitals or near service stations, blasting areas, medical implants or electronic medical devices implanted in the human body (pacemakers, etc.).
- ✓ In any other setting where the risk of interference with other devices or services is a hazard.

If you are not sure of the applicable usage policy for wireless devices in a specific organisation (airport, hospital, etc.) we recommend requesting permission to use wireless communications.

9.3.2.- 3G COMMUNICATIONS

The **line-M-3G** adds 3G connectivity to the **line-EDS** devices connected to it, which allows connection to the devices and the exchange of data with other mobile devices without the need for a Wi-Fi connection. All that is needed is a SIM card.

The 3G communications have to be set up on the **line-EDS** configuration website. Check the **M231B01-03-xxx** manual.

9.4.- TECHNICAL FEATURES: line-M-3G

Power supply		
Mode	Through the line-EDS devices	
AC consumption	2.8 ... 4.1 VA	
ADC consumption	1.9 ... 2.2 W	
Installation category	CAT III 300V	
3G communications		
Networks	UMTS/HSPA+: 800/850/900/1900/2100 MHz GSM/GPRS/EDGE: 850/900/1800/1900 MHz	
Protocols	PPP/TCP/UDP/FTP/HTTP/MMS/SMTP/SSL	
Max. output power	UMTS (Class 3): 24 dBm + 1 dB / - 3dB EDGE 850/900 (Class E2): 27 dBm ± 3dB EDGE 1800/1900 (Class E2): 26 dBm + 3dB / - 4dB GSM 850/900 (Class 4): 33 dBm ± 2dB GSM 1800/1900 (Class 1): 30 dBm ± 2dB	
Antenna		
Band	850 / 900 MHz	1700 / 1800 / 1900 / 2100 MHz
Frequency	824 ... 960 MHz	1710 ... 2170 MHz
Return loss	~ 8.6 dB	~ 89.4 dB
VSWR	~ 2.2:1	~ 2.4:1
Efficiency	~ 70.6 %	~ 56.4 %
Peak gain	~ 2.9 dBi	~ 1.8 dBi
Average gain	~ -1.5 dB	~ - 2.5 dB
Impedance	50 Ω	
Polarisation	Linear	
Radiation pattern	Omni-directional	
Maximum input power	25 W	
Connector type	SMA - Male standard (Right - Angle)	
SIM card		
Type	Micro SIM	
User interface		
LED	4 LEDs	
Environmental features		
Operating temperature	-10°C ... +50°C	
Storage temperature	-20°C ... +70°C	
Relative humidity (non-condensing)	5 ... 95%	
Maximum altitude	2000 m	
Protection degree	IP30, Front: IP40	
Mechanical features		
Dimensions	Version 1.0:	Figure 12 (mm)
	Version 2.0:	Figure 33 (mm)
Weight	Version 1.0:	150 g.
	Version 2.0:	130 g.
Enclosure	Self-extinguishing V0 plastic	
Attachment	DIN rail ⁽²⁴⁾	

⁽²⁴⁾ Recommended minimum distance between DIN rails: 150 mm.

Standards	
Safety requirements for electrical equipment for measurement, control, and laboratory use Part 1: General requirements.	EN 61010-1
Electromagnetic compatibility (EMC) Part 6-2: General standards. Immunity for industrial environments.	EN 61000-6-2
Electromagnetic Compatibility (EMC) Part 6-4: General standards. Emission standard for industrial environments. (IEC 61000-6-4: 2006).	EN 61000-6-4

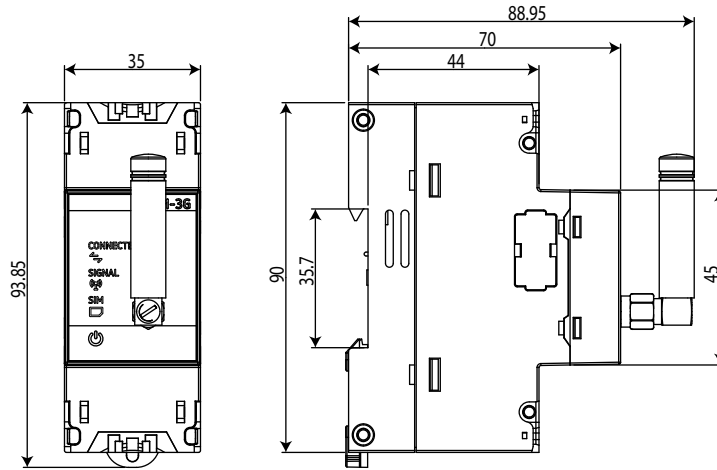

Figure 33: line-M-3G dimensions: Version 2.0.

10.- line-TCPRS1

The **line-TCPRS1** is a gateway designed to convert an RS-485 or RS-232 physical environment to Ethernet and/or Wi-Fi. The device features a Web Server and an app, **MyConfig** (Android), that uses Bluetooth connectivity®, from which the user can completely edit the configuration parameters of the device.

The device can be connected via the side bus with up to 7 devices of the **line** range: **line-CVM-D32** and **line-M-xxx-xx** expansion modules. It also has RS-485 and RS-232 communication terminals (external bus) so that it can be simultaneously connected to other devices not in the **line** range.

Note: The peripheral numbers of the devices connected via the side bus are: 2, 3, 4... successively and in order. There may be conflicts and/or collisions if devices are connected to the external bus with peripheral numbers between 2 and 8.

Note: Peripheral number 1 can be used on the external bus.

Note: For ModbusTCP and TCP protocols, the **line-TCPRS1** can be queried for up to 5 Masters at the same time.



10.1.- INSTALLATION

The device must be connected to a power circuit that is protected with gI (IEC 269) or M type fuses with a rating of 1 to 2 A. It must be fitted with a circuit breaker or equivalent device, in order to be able to disconnect the device from the power supply network.

The power and voltage measuring circuit must be connected with cables that have a minimum cross-section of 1mm².

10.2.- DEVICE TERMINALS

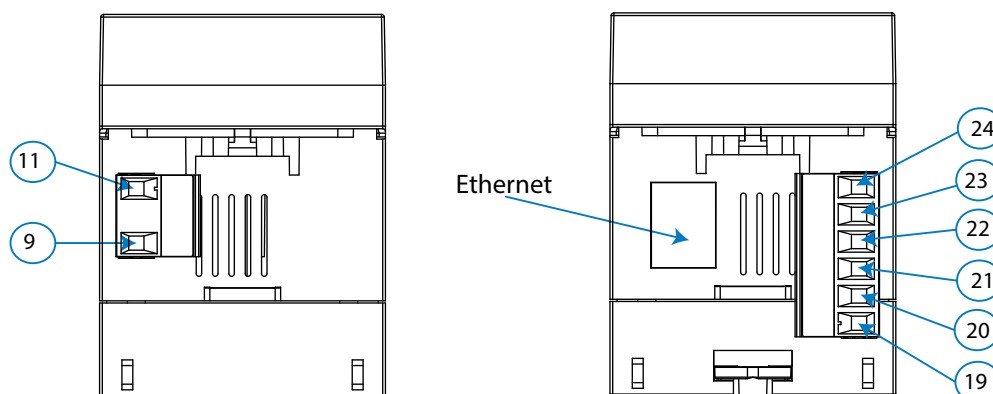

Figure 34: line-TCPRS1 terminals: Upper - lower.

Table 40: List of line-TCPRS1 terminals.

Device terminals	
9: A1 ~/+, Power supply	22: B-, RS-485
11: A2 ~/-, Power supply	23: S, GND for RS-485
19: Common, GND for RS-232	24: A+, RS-485
20: Rx, RS-232	Ethernet: Ethernet connection
21: Tx, RS-232	

Note: For the correct operation of serial communications, the RS-485 and RS-232 ports should not be wired at the same time.

10.3.- LED INDICATORS

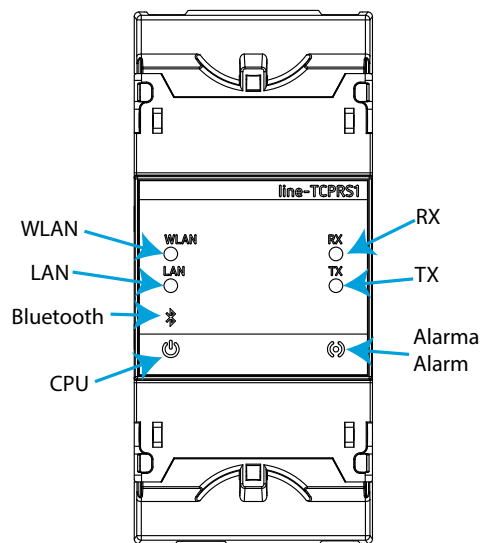

Figure 35: LEDs: line-TCPRS1.

The line-TCPRS1 have 7 indicating LEDs:

✓ CPU, Indicates device status:

Table 41: LED CPU.

LED	Description
CPU	Flashing:
	<i>White:</i> Indicates that the device is powered

✓ WLAN, Indicates the status of Wi-Fi connectivity:

Table 42: LED WLAN.

LED	Description
WLAN	On:
	<i>Blue color:</i> Indicates that the Wi-Fi connection is activated

✓ LAN, Indicates the status of Ethernet connectivity:

Table 43: LED LAN.

LED	Description
LAN	On:
	<i>Green color:</i> Indicates that the Ethernet connection is activated

- ✓ **Bluetooth**, Indicates the status of Bluetooth® connectivity:

Table 44: LED Bluetooth.

LED	Description
Bluetooth	On:
	<i>Blue color:</i> Bluetooth® linked

- ✓ **RX, TX**, Indicates the status of RS-485 / RS-232 communications:

Table 45: LEDs RX and TX.

LED	Description
RX	Flashing:
	<i>Orange color:</i> Indicates the frame reception
TX	Flashing:
	<i>Orange color:</i> Indicates the frame delivery

- ✓ **Alarm**, Indicates that an alarm has been generated:

Table 46: LED Alarm.

LED	Description
Alarm	On:
	<i>Red color:</i> Frame reception error

10.4.- COMMUNICATIONS

10.4.1.- USAGE ENVIRONMENT AND HEALTH

See section "9.3.1.- USAGE ENVIRONMENT AND HEALTH".

10.4.2.- Wi-Fi COMMUNICATIONS

Wi-Fi is one of the most widespread wireless technologies today. It is used to connect electronic devices and exchange information between them without having to connect them physically.

The **line-TCPRS1** devices feature Wi-Fi communications in the 2.4GHz band, and are compliant with the IEEE 802.11b, IEEE 802.11g and IEEE 802.11n standards.

10.4.3.- Bluetooth® COMMUNICATIONS

The device features Bluetooth® wireless communication.

Bluetooth® is a short-range wireless technology that allows wireless data transfers between devices within a range of approximately 10 metres.

10.4.4.- CONFIGURATION WEBSITE

To access the internal configuration website, the device's IP address has to be entered into the browser address bar. The **line-TCPRS1** is set by default to DHCP mode.

The IP address can be obtained via Bluetooth® using the **MyConfig** application. The device can be identified by its MAC address using software such as *Advanced IP Scanner* or *IP Setup Program*.

The website of the device can be used to:

- ✓ On the **Device Info** screen, view the device's information and settings for Ethernet, Bluetooth®, Wi-Fi and RS-485/RS-232 communications (**Figure 36**).

Circutor	line-TCPRS1
Device Info	Device Info
Communications	
Settings	
Firmware	
	Device Variables
	Serial Number SERIAL_N123456
	Manufacturing Date Year: 20ER Week: IA
	Firmware Version 1.2.3
	Ethernet Communications
	DHCP Disabled
	Ethernet Link Status Disconnected
	Ethernet IP 10.0.120.21
	Ethernet Netmask 255.255.255.0
	Ethernet Gateway 10.0.120.254
	Ethernet MAC C8:2B:96:A9:44:1F
	Wi-Fi Communications
	Wi-Fi Enabled
	Wi-Fi Status  38% Connected
	Wi-Fi Name (SSID) CIRCUTOR-WIFI
	Wi-Fi IP 10.0.123.69
	Wi-Fi Netmask 255.255.255.0
	Wi-Fi Gateway 10.0.123.254
	Wi-Fi MAC C8:2B:96:A9:44:1C
	Bluetooth
	Bluetooth Name line-TCPRS1-3456
	Serial port
	Interface 485
	BaudRate 115200
	DataBits 8
	Parity None
	StopBits 1
	Protocol
	Protocol ModbusTCP
	Port 502
	RTU timeout 1000
	TX delay 10

Figure 36: Website: Device Info.

- ✓ On the **Communications** screen, edit the Ethernet and Wi-Fi communications settings (Figure 37).

Circutor line-TCPRS1

Device Info

Communications

Settings

Firmware

Communications

Ethernet Communications

DHCP

Ethernet IP	10.0.120.21
Ethernet Netmask	255.255.255.0
Ethernet Gateway	10.0.120.254

Wi-Fi Communications

Wi-Fi

Wi-Fi Name (SSID)	CIRCUTOR-WIFI
Wi-Fi Password

Figure 37: Website: Communications.

- ✓ On the **Settings** screen, edit the RS-485/RS-232 communications settings (Figure 38).

Circutor line-TCPRS1

Device Info

Communications

Settings

Firmware

Settings

Serial port

Interface	485
BaudRate	115200
DataBits	8
Parity	None
StopBits	1

Protocol

Protocol	ModbusTCP
Port	502
RTU timeout	1000
TX delay	10

Figure 38: Website: Settings.

- ✓ On the **Firmware** screen, update the device's firmware (Figure 39).

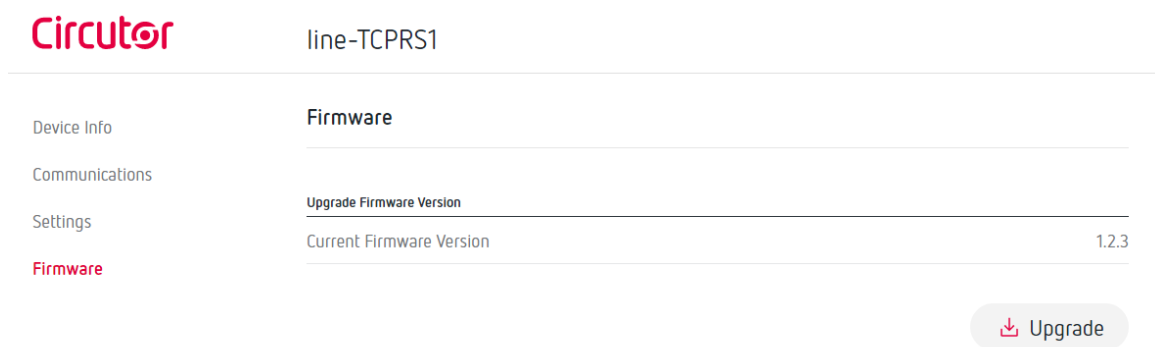

Figure 39: Website: Firmware.



10.4.5.- MOBILE APP

The **MyConfig** mobile app, which can be used to set up Wi-Fi and Ethernet communications via Bluetooth®, can be downloaded free of charge from Google Play (Android).

10.5.- TECHNICAL FEATURES: line-TCPRS1

AC Power supply	
Rated voltage	80 ... 264 V~
Frequency	50 ... 60 Hz
Consumption	3.5 ... 7.5 VA
Installation category	CAT III 300V
DC Power supply	
Rated voltage	100 ... 300 V ---
Consumption	2 ... 2.5 W
Installation category	CAT III 300V
RS-485 interface	
Bus	RS-485
Baud rate	4800 - 9600 - 19200 - 38400 - 57600 - 115200 bps
Data bits	7 - 8
Stop bits	1 - 2
Parity	without - even - odd
RS-232 interface	
Bus	RS-232
Baud rate	4800 - 9600 - 19200 - 38400 - 57600 - 115200 bps
Data bits	7 - 8
Stop bits	1 - 2
Parity	without - even - odd
Ethernet Interface	
Type	Ethernet 10BaseT - 100BaseTX self-detectable
Connector	RJ45
Protocol	TCP - UDP - Modbus TCP - HTTP (Web server) - REST
Connection mode to network	DHCP ON/OFF (ON by default)
Wi-Fi communication	
Band	2.4 GHz (Range: 2.4 ... 2.5 GHz)
Standard	IEEE 802.11 b / g , IEEE 802.11 n (up to 150 Mbps)
Max. output power	IEEE 802.11 b: 20 dBm IEEE 802.11 n: 14 dBm
Bluetooth® communication	
Protocols	Bluetooth® v4.2 BR/EDR and BLE specification
Radio	NZIF receiver with -97 dBm sensitivity Class-1, class-2 and class-3 transmitter Adaptive Frequency Hopping (AFH) Receiver Sensitivity @30.8% PER -97 dBm Transmitter RF power control range Min: -12 dBm / Max: +12dBm
User interface	
LED	7 LEDs
Environmental features	
Operating temperature	-10°C ... +50°C
Storage temperature	-20°C ... +70°C

(Continuation) Environmental features	
Relative humidity (non-condensing)	5 ... 95%
Maximum altitude	2000 m
Protection degree	IP30, Front: IP40

Mechanical features			
Terminals			
9, 11, 19 ... 24	2.5 mm ²	≤ 0.4 Nm, M2.5	flat
Dimensions	Figure 12 (mm)		
Weight	170 g.		
Enclosure	Self-extinguishing V0 plastic		
Attachment	DIN rail ⁽²⁵⁾		

⁽²⁵⁾ Recommended minimum distance between DIN rails: 150 mm.

Standards	
Safety requirements for electrical equipment for measurement, control, and laboratory use Part 1: General requirements.	EN 61010-1
Electromagnetic compatibility (EMC) Part 6-2: General standards. Immunity for industrial environments.	EN 61000-6-2
Electromagnetic Compatibility (EMC) Part 6-4: General standards. Emission standard for industrial environments. (IEC 61000-6-4: 2006).	EN 61000-6-4
Safety Requirements for Electrical Equipment for Measurement, Control, and Laboratory Use - Part 1: General Requirements	UL 61010-1

11.- line-M-20I

The **line-M-20I** is a centraliser with 20 digital inputs that is designed to centralise the logical status of each signal or to count the number of impulses received at each input.

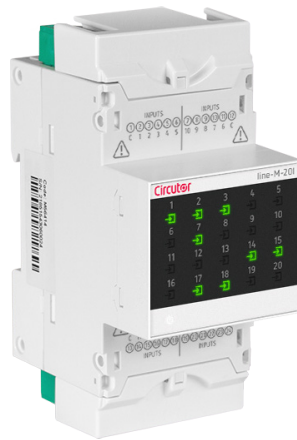

The device can be connected via the side bus to the devices of the **line** range: **line-TCPRS1** and **line-EDS**.

11.1.- INSTALLATION



Only 2 **line-M-20I** centraliser can be connect to the right of the **line-TCPRS1** devices (without adding the **line-M-EXT-PS** power adapter).

11.2.- DEVICE TERMINALS

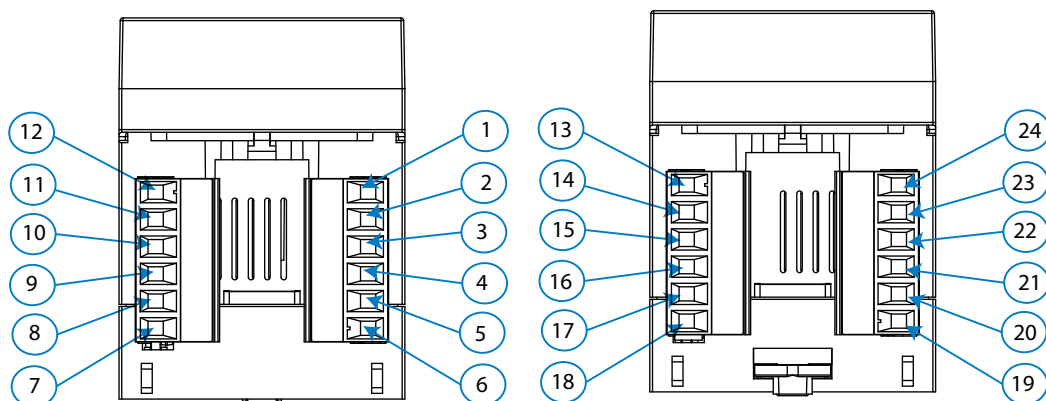

Figure 40: line-M-20I terminals: Upper - lower.

Table 47: line-M-20I device terminals.

Device terminals	
1: C, Common for digital input 1-5	13: C, Common for digital input 11-15
2: 1, Digital input 1	14: 11, Digital input 11
3: 2, Digital input 2	15: 12, Digital input 12
4: 3, Digital input 3	16: 13, Digital input 13
5: 4, Digital input 4	17: 14, Digital input 14
6: 5, Digital input 5	18: 15, Digital input 15
7: 10, Digital input 10	19: 16, Digital input 16
8: 9, Digital input 9	20: 17, Digital input 17
9: 8, Digital input 8	21: 18, Digital input 18
10: 7, Digital input 7	22: 19, Digital input 19
11: 6, Digital input 6	23: 20, Digital input 20
12: C, Common for digital input 6-10	24: C, Common for digital input 16-20

11.3.- CONNECTION DIAGRAM

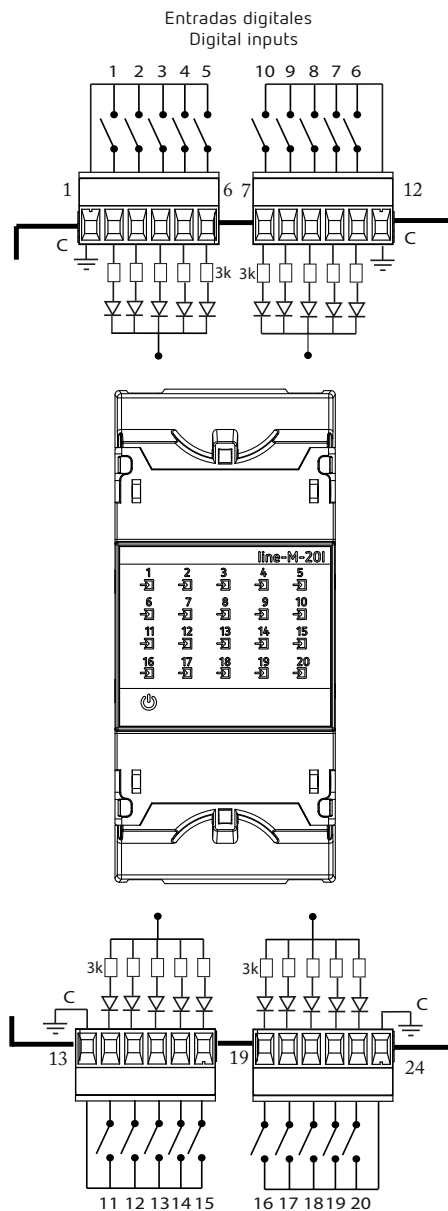

Figure 41: line-M-20I connection diagram.

11.4.- LED INDICATORS

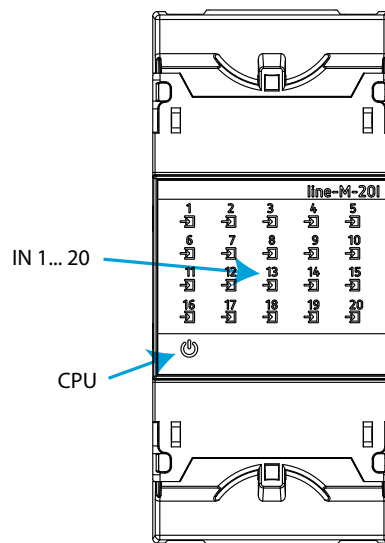

Figure 42: LEDs: line-M-20I.

The **line-M-20I** have 21 indicating LEDs:

✓ **CPU**, Indicates device status:

Table 48: LED CPU.

LED	Description
CPU	Flashing:
	<i>White</i> : Indicates that the device is powered

✓ **IN x**, Indicates the status of digital input x:

Table 49: LED IN x.

LED	Description
IN x	On:
	<i>Green color</i> : Indicates that input x is activated

11.5.- MODBUS MEMORY MAP

All the addresses on the MODBUS map are in Hexadecimal.

11.5.1.- DIGITAL INPUTS

The **Function 0x02**, is implemented for these variables.

Table 50: Modbus Memory Map: Digital inputs status.

Parameter	Format	Address	Value
Status of digital input 1	bool	0000	0: Deactivated , 1: Activated
Status of digital input 2		0001	
Status of digital input 3		0002	
Status of digital input 4		0003	

Table 50 (Continuation): Modbus Memory Map: Digital inputs status.

Parameter	Format	Address	Value
Status of digital input 5	bool	0004	0: Deactivated , 1: Activated
Status of digital input 6		0005	
Status of digital input 7		0006	
Status of digital input 8		0007	
Status of digital input 9		0008	
Status of digital input 10		0009	
Status of digital input 11		000A	
Status of digital input 12		000B	
Status of digital input 13		000C	
Status of digital input 14		000D	
Status of digital input 15		000E	
Status of digital input 16		000F	
Status of digital input 17		0010	
Status of digital input 18		0011	
Status of digital input 19		0012	
Status of digital input 20		0013	

11.5.2.- PULSE METERS

The **Function 0x04**: register readout, is implemented for these variables.

Table 51: Modbus Memory Map: Pulse meter.

Parameter	Format	Address
Pulse counter of digital input 1	Uint [64]	59D8 - 59D9 - 59DA - 59DB
Pulse counter of digital input 2		59DC - 59DD - 59DE - 59DF
Pulse counter of digital input 3		59E0 - 59E1 - 59E2 - 59E3
Pulse counter of digital input 4		59E4 - 59E5 - 59E6 - 59E7
Pulse counter of digital input 5		59E8 - 59E9 - 59EA - 59EB
Pulse counter of digital input 6		59EC - 59ED - 59EE - 59EF
Pulse counter of digital input 7		59F0 - 59F1 - 59F2 - 59F3
Pulse counter of digital input 8		59F4 - 59F5 - 59F6 - 59F7
Pulse counter of digital input 9		59F8 - 59F9 - 59FA - 59FB
Pulse counter of digital input 10		59FC - 59FD - 59FE - 59FF
Pulse counter of digital input 11		5A00 - 5A01 - 5A02 - 5A03
Pulse counter of digital input 12		5A04 - 5A05 - 5A06 - 5A07
Pulse counter of digital input 13		5A08 - 5A09 - 5A0A - 5A0B
Pulse counter of digital input 14		5A0C - 5A0D - 5A0E - 5A0F
Pulse counter of digital input 15		5A10 - 5A11 - 5A12 - 5A13
Pulse counter of digital input 16		5A14 - 5A15 - 5A16 - 5A17
Pulse counter of digital input 17		5A18 - 5A19 - 5A1A - 5A1B
Pulse counter of digital input 18		5A1C - 5A1D - 5A1E - 5A1F
Pulse counter of digital input 19		5A20 - 5A21 - 5A22 - 5A23
Pulse counter of digital input 20		5A24 - 5A25 - 5A26 - 5A27

Parameter deletion is carried out by **Function 05**: writing a relay.

Table 52: Modbus Memory Map: Pulse meter deletion.

Deleting parameters	Format	Address	Value to be sent
Deleting the pulse counters	Bool	0898	0xFF00

11.5.3.- OTHER DEVICE PARAMETERS

The **Function 0x04**: register readout, is implemented for these variables.

Table 53: Modbus Memory Map: Other device parameters.

Parameter	Format	Address
Device ID number	Uint [32]	F00A - F00B
Device serial number	String	F000 - F001 -F002 -F003 -F004 -F005 -F006
Firmware version (part 1)	Uint [16]	C288
Firmware version (part 2)	Uint [16]	C289
Firmware version revision	Uint [16]	C28A
Device model	String	C28C - C28D

11.5.4.- DEVICE CONFIGURATION VARIABLES

The following functions are used for these variables:

Function 0x03: register readout.

Function 0x10: Writing multiple registers.

11.5.4.1.-Digital Input Configuration

Table 54: Modbus Memory Map: Digital Inputs.



Parameter	Format	Address	Valid data range	Default value
Digital Input 1: Mode	Int [16]	4FB0	0 : Status input - >0: Pulse input (energy per pulse) ⁽²⁶⁾	0
Digital Input 2: Mode		4FBC		
Digital Input 3: Mode		4FC8		
Digital Input 4: Mode		4FD4		
Digital Input 5: Mode		4FE0		
Digital Input 6: Mode		4FEC		
Digital Input 7: Mode		4FF8		
Digital Input 8: Mode		5004		
Digital Input 9: Mode		5010		
Digital Input 10: Mode		501C		
Digital Input 11: Mode		5028		
Digital Input 12: Mode		5034		
Digital Input 13: Mode		5040		
Digital Input 14: Mode		504C		
Digital Input 15: Mode		5058		
Digital Input 16: Mode		5064		

Table 54 (Continuation): Modbus Memory Map: Digital Inputs.

Parameter	Format	Address	Valid data range	Default value
Digital Input 17: Mode	Int [16]	5070	0 : Entrada de estado - >0: Entrada de pulso (energía por pulso) ⁽²⁶⁾	0
Digital Input 18: Mode		507C		
Digital Input 19: Mode		5088		
Digital Input 20: Mode		5094		

⁽²⁶⁾ To configure the Operating Mode as **pulse input**, this parameter must be set to **Energy per pulse** (Value > 0).

11.6.- TECHNICAL FEATURES: line-M-20I

DC power supply			
Mode	Through the connector		
Rated voltage	12 V ---		
Consumption	3.5 W		
Installation category	CAT III 300V		
Digital inputs			
Quantity	20		
Type	Optocoupler		
Insulation	4.2 kV ---		
Input impedance	1.4 kΩ		
Consumption	60 mA inputs OFF 240 mA inputs ON		
User interface			
LED	21 LEDs		
Environmental features			
Operating temperature	-10°C ... +50°C		
Storage temperature	-20°C ... +70°C		
Relative humidity (non-condensing)	5 ... 95%		
Maximum altitude	2000 m		
Protection degree	IP30, Front: IP40		
Mechanical features			
Terminals			
1 ... 24	2.5 mm ²	≤ 0.4 Nm, M2.5	flat
Dimensions	Figure 12 (mm)		
Weight	130 g.		
Enclosure	Self-extinguishing V0 plastic		
Attachment	DIN rail ⁽²⁷⁾		
⁽²⁷⁾ Recommended minimum distance between DIN rails: 150 mm.			
Standards			
Safety requirements for electrical equipment for measurement, control, and laboratory use Part 1: General requirements.	EN 61010-1		
Electromagnetic compatibility (EMC) Part 6-2: General standards. Immunity for industrial environments.	EN 61000-6-2		
Electromagnetic Compatibility (EMC) Part 6-4: General standards. Emission standard for industrial environments. (IEC 61000-6-4: 2006).	EN 61000-6-4		

(Continuation)Standards	
Safety Requirements for Electrical Equipment for Measurement, Control, and Laboratory Use - Part 1: General Requirements	UL 61010-1

12.- line-LM20I-TCP kit

The **line-LM20I-TCP kit** is a centraliser with 20 digital inputs with a gateway designed to convert an RS-485 or RS-232 physical environment to Ethernet and/or Wi-Fi.

The device is designed to centralise the logical status of each signal or to count the number of impulses received at each input. The **line-LM20I-TCP kit** features a Web Server and an app, **MyConfig** (Android), that uses Bluetooth® connectivity, from which the user can completely edit the configuration parameters of the device.



The device also has RS-485 and RS-232 communication terminals so that it can be simultaneously connected to other devices not in the **line** range.

Note: *The devices connected to the RS-485 or RS-232 communication terminals have to be configured with a peripheral number ≥ 10 .*

12.1.- INSTALLATION

The device must be connected to a power circuit that is protected with gI (IEC 269) or M type fuses with a rating of 1 to 2 A. It must be fitted with a circuit breaker or equivalent device, in order to be able to disconnect the device from the power supply network.

The power and voltage measuring circuit must be connected with cables that have a minimum cross-section of 1mm².

12.2.- DEVICE TERMINALS

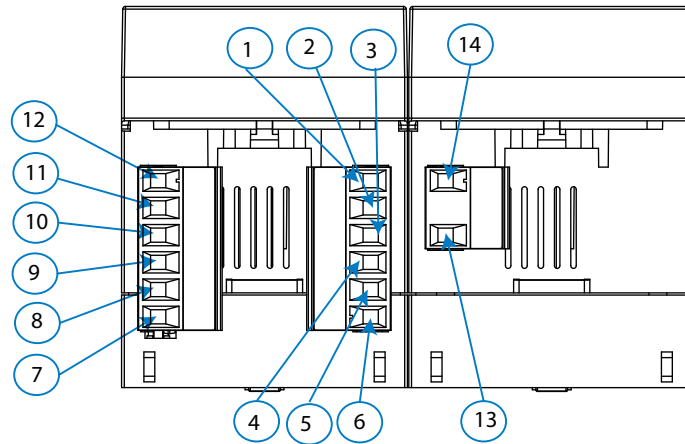

Figure 43: line-LM20I-TCP kit terminals: Upper.

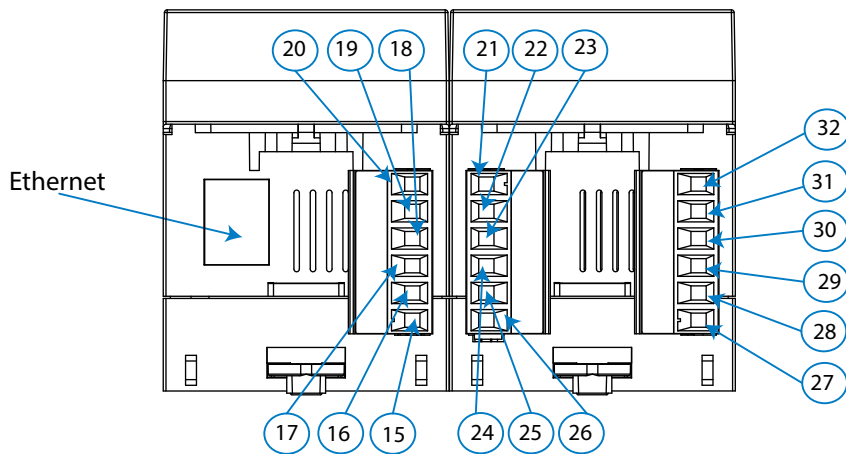

Figure 44: line-LM20I-TCP kit terminals: lower.

Table 55: List of line-LM20I-TCP kit terminals.

Device terminals	
1: C, Common for digital input 1-5	18: B-, RS-485
2: 1, Digital input 1	19: S, GND for RS-485
3: 2, Digital input 2	20: A+, RS-485
4: 3, Digital input 3	21: C, Common for digital input 11-15
5: 4, Digital input 4	22: 11, Digital input 11
6: 5, Digital input 5	23: 12, Digital input 12
7: 10, Digital input 10	24: 13, Digital input 13
8: 9, Digital input 9	25: 14, Digital input 14
9: 8, Digital input 8	26: 15, Digital input 15
10: 7, Digital input 7	27: 16, Digital input 16
11: 6, Digital input 6	28: 17, Digital input 17
12: C, Common for digital input 6-10	29: 18, Digital input 18
13: A1 ~ /+, Power supply	30: 19, Digital input 19
14: A1 ~ /-, Power supply	31: 20, Digital input 20
15: Common, GND for RS-232	32: C, Common for digital input 16-20
16: Rx, RS-232	Ethernet: Ethernet connection
17: Tx, RS-232	

Note: For the correct operation of serial communications, the RS-485 and RS-232 ports should not be wired at the same time.

12.3.- CONNECTION DIAGRAM

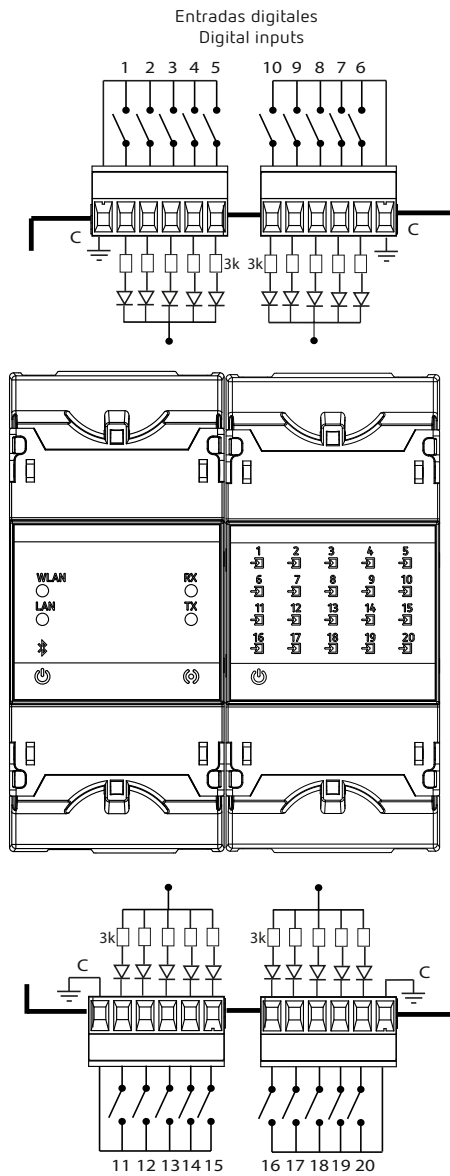

Figure 45: line-LM201-TCP kit connection diagram.

12.4.- LED INDICATORS

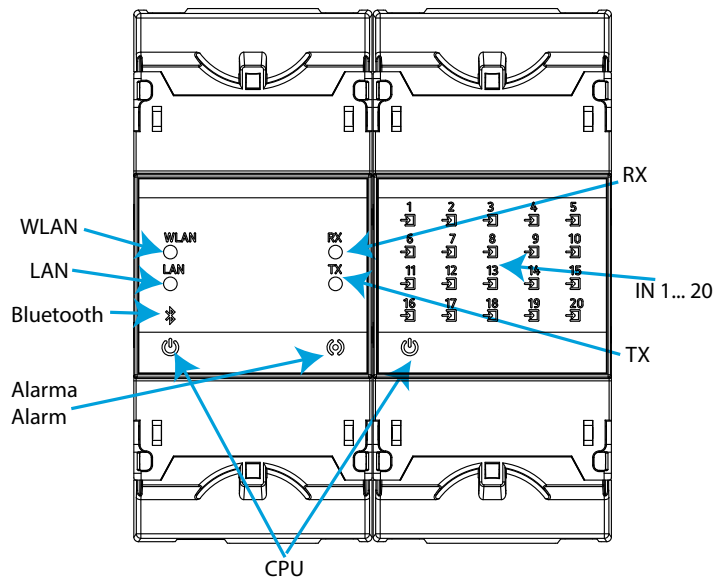

Figure 46: LEDs: line-LM20I-TCP kit.

The **line-LM20I-TCP** kit have 28 indicating LEDs:

- ✓ **CPU**, Indicates device status:

Table 56: LED CPU.

LED	Description
CPU	Flashing:
	<i>White</i> : Indicates that the device is powered

- ✓ **WLAN**, Indicates the status of Wi-Fi connectivity:

Table 57: LED WLAN.

LED	Description
WLAN	On:
	<i>Blue color</i> : Indicates that the Wi-Fi connection is activated

- ✓ **LAN**, Indicates the status of Ethernet connectivity:

Table 58: LED LAN.

LED	Description
LAN	On:
	<i>Green color</i> : Indicates that the Ethernet connection is activated

- ✓ **Bluetooth**, Indicates the status of Bluetooth® connectivity:

Table 59: LED Bluetooth.

LED	Description
Bluetooth	On:
	<i>Blue color</i> : Bluetooth® linked

- ✓ **RX, TX**, Indicates the status of RS-485 / RS-232 communications:

Table 60: LEDs RX and TX.

LED	Description
RX	Flashing:
	<i>Orange color:</i> Indicates the frame reception
TX	Flashing:
	<i>Orange color:</i> Indicates the frame delivery

- ✓ **Alarm**, Indicates that an alarm has been generated:

Table 61: LED Alarm.

LED	Description
Alarm	On:
	<i>Red color:</i> Frame reception error

- ✓ **IN x**, Indicates the status of digital input x:

Table 62: LED IN x.

LED	Description
IN x	On:
	<i>Green color:</i> Indicates that input x is activated

12.5.- MODBUS MEMORY MAP

The modbus memory map of the device is identical to that of the **line-M-20I** device, see section "**11.5 - MODBUS MEMORY MAP**".

12.6.- COMMUNICATIONS

12.6.1.- USAGE ENVIRONMENT AND HEALTH

See section "**9.3.1.- USAGE ENVIRONMENT AND HEALTH**".

12.6.2.- Wi-Fi COMMUNICATIONS

Wi-Fi is one of the most widespread wireless technologies today. It is used to connect electronic devices and exchange information between them without having to connect them physically.

The **line-LM20I-TCP kit** devices feature Wi-Fi communications in the 2.4GHz band, and are compliant with the IEEE 802.11b, IEEE 802.11g and IEEE 802.11n standards.

12.6.3.- Bluetooth® COMMUNICATIONS

The device features Bluetooth® wireless communication.

Bluetooth® is a short-range wireless technology that allows wireless data transfers between devices within a range of approximately 10 metres.

12.6.4.- CONFIGURATION WEBSITE

To access the internal configuration website, the device's IP address has to be entered into the browser address bar. The **line-LM20I-TCP kit** is set by default to DHCP mode.

The IP address can be obtained via Bluetooth® using the **MyConfig** application. The device can be identified by its MAC address using software such as *Advanced IP Scanner* or *IP Setup Program*.



See section *"10.4.4.- CONFIGURATION WEBSITE"*.

12.6.5.- MOBILE APP

The **MyConfig** mobile app, which can be used to set up Wi-Fi and Ethernet communications via Bluetooth®, can be downloaded free of charge from Google Play (Android).

12.7.- TECHNICAL FEATURES: line-LM20I-TCP kit

AC Power supply	
Rated voltage	80 ... 264 V~
Frequency	50 ... 60 Hz
Consumption	7 ... 11 VA
Installation category	CAT III 300V
DC Power supply	
Rated voltage	100 ... 300 V ===
Consumption	5.5 ... 6 W
Installation category	CAT III 300V
Digital inputs	
Quantity	20
Type	Optocoupler
Insulation	4.2 kV ===
Input impedance	1.4 kΩ
Consumption	60 mA inputs OFF 240 mA inputs ON
RS-485 interface	
Bus	RS-485
Baud rate	4800 - 9600 - 19200 - 38400 - 57600 - 115200 bps
Data bits	7 - 8
Stop bits	1 - 2
Parity	without - even - odd
RS-232 interface	
Bus	RS-232
Baud rate	4800 - 9600 - 19200 - 38400 - 57600 - 115200 bps
Data bits	7 - 8
Stop bits	1 - 2
Parity	without - even - odd

Ethernet Interface			
Type	Ethernet 10BaseT - 100BaseTX self-detectable		
Connector	RJ45		
Protocol	TCP - UDP - Modbus TCP - HTTP (Web server) - REST		
Connection mode to network	DHCP ON/OFF (ON by default)		
Wi-Fi communication			
Band	2.4 GHz (Range: 2.4 ... 2.5 GHz)		
Standard	IEEE 802.11 b / g , IEEE 802.11 n (up to 150 Mbps)		
Max. output power	IEEE 802.11 b: 20 dBm IEEE 802.11 n: 14 dBm		
Bluetooth® communication			
Protocols	Bluetooth® v4.2 BR/EDR and BLE specification		
Radio	NZIF receiver with -97 dBm sensitivity Class-1, class-2 and class-3 transmitter Adaptive Frequency Hopping (AFH) Receiver Sensitivity @30.8% PER -97 dBm Transmitter RF power control range Min: -12 dBm / Max: +12dBm		
User interface			
LED	28 LEDs		
Environmental features			
Operating temperature	-10°C ... +50°C		
Storage temperature	-20°C ... +70°C		
Relative humidity (non-condensing)	5 ... 95%		
Maximum altitude	2000 m		
Protection degree	IP30, Front: IP40		
Mechanical features			
Terminals			
1 ... 32	2.5 mm ²	≤ 0.4 Nm, M2.5	flat
Dimensions	Figure 47 (mm)		
Weight	300 g.		
Enclosure	Self-extinguishing V0 plastic		
Attachment	DIN rail ⁽²⁸⁾		
⁽²⁸⁾ Recommended minimum distance between DIN rails: 150 mm.			
Standards			
Safety requirements for electrical equipment for measurement, control, and laboratory use Part 1: General requirements.	EN 61010-1		
Electromagnetic compatibility (EMC) Part 6-2: General standards. Immunity for industrial environments.	EN 61000-6-2		
Electromagnetic Compatibility (EMC) Part 6-4: General standards. Emission standard for industrial environments. (IEC 61000-6-4: 2006).	EN 61000-6-4		
Safety Requirements for Electrical Equipment for Measurement, Control, and Laboratory Use - Part 1: General Requirements	UL 61010-1		

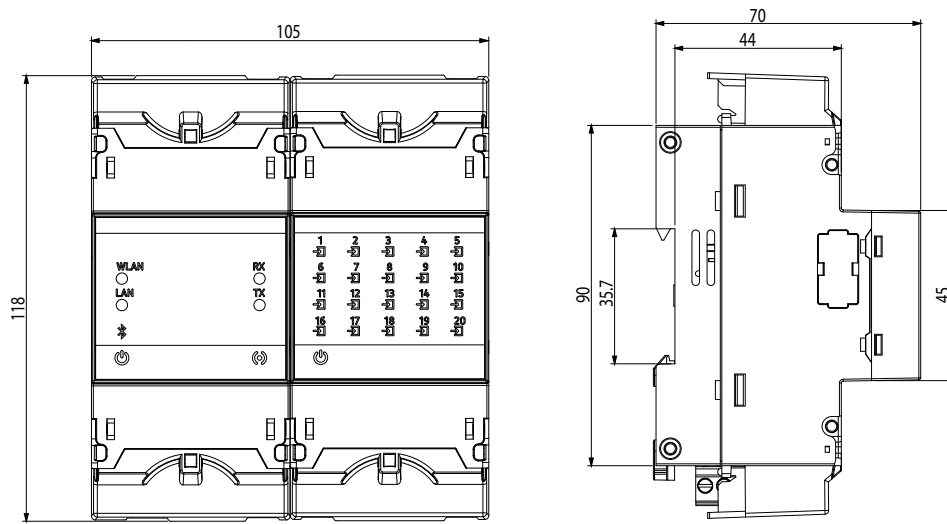

Figure 47: line-LM20I-TCP kit dimensions.

13.- line-LM40I-TCP kit

The **line-LM40I-TCP kit** is a centraliser with 40 digital inputs with a gateway designed to convert an RS-485 or RS-232 physical environment to Ethernet and/or Wi-Fi.

The device is designed to centralise the logical status of each signal or to count the number of impulses received at each input. The **line-LM40I-TCP kit** features a Web Server and an app, **MyConfig** (Android), that uses Bluetooth® connectivity, from which the user can completely edit the configuration parameters of the device.



The device also has RS-485 and RS-232 communication terminals so that it can be simultaneously connected to other devices not in the **line** range.

Note: *The devices connected to the RS-485 or RS-232 communication terminals have to be configured with a peripheral number ≥ 10 .*

13.1.- INSTALLATION

The device must be connected to a power circuit that is protected with gI (IEC 269) or M type fuses with a rating of 1 to 2 A. It must be fitted with a circuit breaker or equivalent device, in order to be able to disconnect the device from the power supply network.

The power and voltage measuring circuit must be connected with cables that have a minimum cross-section of 1mm².

13.2. - DEVICE TERMINALS

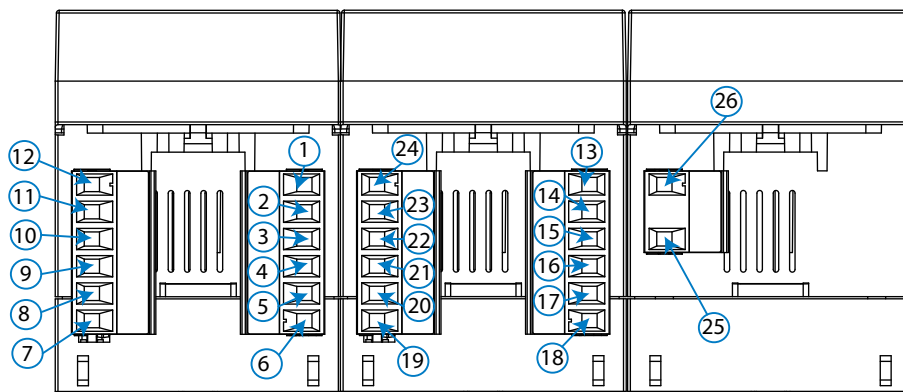

Figure 48: line-LM40I-TCP kit terminals: Upper.

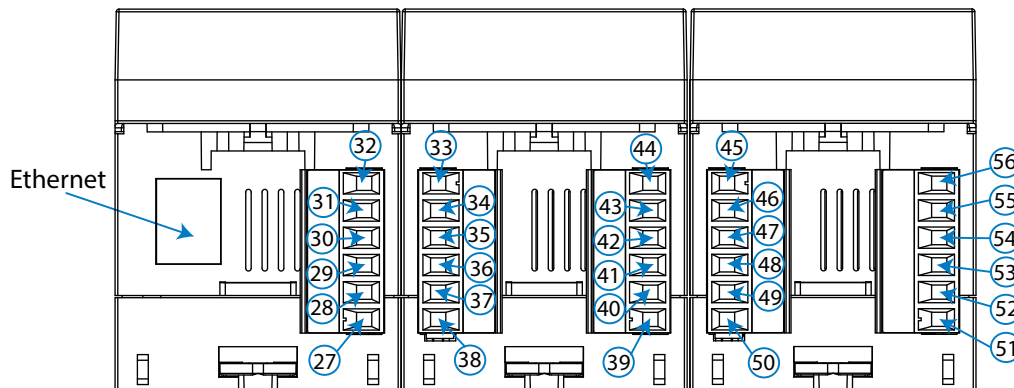

Figure 49: line-LM40I-TCP kit terminals: lower.

Table 63: List of line-LM40I-TCP kit terminals.

Device terminals		
1: C, Common for digital input 1-5 ⁽²⁹⁾	20: 9, Digital input 9 ⁽³⁰⁾	39: 16, Digital input 16 ⁽³⁰⁾
2: 1, Digital input 1 ⁽²⁹⁾	21: 8, Digital input 8 ⁽³⁰⁾	40: 17, Digital input 17 ⁽³⁰⁾
3: 2, Digital input 2 ⁽²⁹⁾	22: 7, Digital input 7 ⁽³⁰⁾	41: 18, Digital input 18 ⁽³⁰⁾
4: 3, Digital input 3 ⁽²⁹⁾	23: 6, Digital input 6 ⁽³⁰⁾	42: 19, Digital input 19 ⁽³⁰⁾
5: 4, Digital input 4 ⁽²⁹⁾	24: C, Common for digital input 6-10 ⁽³⁰⁾	43: 20, Digital input 20 ⁽³⁰⁾
6: 5, Digital input 5 ⁽²⁹⁾	25: A1 ~ /+, Power supply	44: C, Common for digital input 16-20 ⁽³⁰⁾
7: 10, Digital input 10 ⁽²⁹⁾	26: A2 ~ /-, Power supply	45: C, Common for digital input 11-15 ⁽²⁹⁾
8: 9, Digital input 9 ⁽²⁹⁾	27: Common, GND for RS-232	46: 11, Digital input 11 ⁽²⁹⁾
9: 8, Digital input 8 ⁽²⁹⁾	28: Rx, RS-232	47: 12, Digital input 12 ⁽²⁹⁾
10: 7, Digital input 7 ⁽²⁹⁾	29: Tx, RS-232	48: 13, Digital input 13 ⁽²⁹⁾
11: 6, Digital input 6 ⁽²⁹⁾	30: B-, RS-485	49: 14, Digital input 14 ⁽²⁹⁾
12: C, Common for digital input 6-10 ⁽²⁹⁾	31: S, GND for RS-485	50: 15, Digital input 15 ⁽²⁹⁾
13: C, Common for digital input 1-5 ⁽³⁰⁾	32: A+, RS-485	51: 16, Digital input 16 ⁽²⁹⁾
14: 1, Digital input 1 ⁽³⁰⁾	33: C, Common for digital input 11-15 ⁽³⁰⁾	52: 17, Digital input 17 ⁽²⁹⁾
15: 2, Digital input 2 ⁽³⁰⁾	34: 11, Digital input 11 ⁽³⁰⁾	53: 18, Digital input 18 ⁽²⁹⁾
16: 3, Digital input 3 ⁽³⁰⁾	35: 12, Digital input 12 ⁽³⁰⁾	54: 19, Digital input 19 ⁽²⁹⁾
17: 4, Digital input 4 ⁽³⁰⁾	36: 13, Digital input 13 ⁽³⁰⁾	55: 20, Digital input 20 ⁽²⁹⁾
18: 5, Digital input 5 ⁽³⁰⁾	37: 14, Digital input 14 ⁽³⁰⁾	56: C, Common for digital input 16-20 ⁽²⁹⁾
19: 10, Digital input 10 ⁽³⁰⁾	38: 15, Digital input 15 ⁽³⁰⁾	Ethernet: Ethernet connection

⁽²⁹⁾ Module 2.⁽³⁰⁾ Module 1.

Note: For the correct operation of serial communications, the RS-485 and RS-232 ports should not be wired at the same time.

13.3.- CONNECTION DIAGRAM

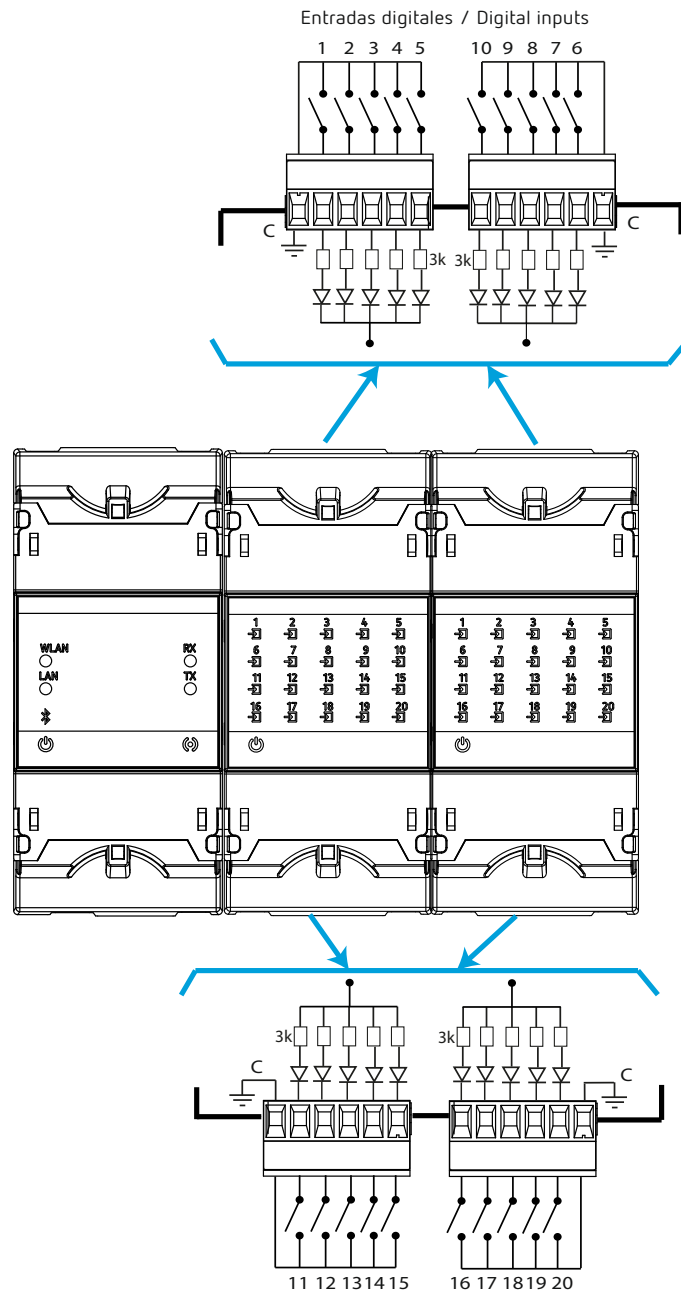

Figure 50: line-LM40I-TCP kit connection diagram.

13.4.- LED INDICATORS

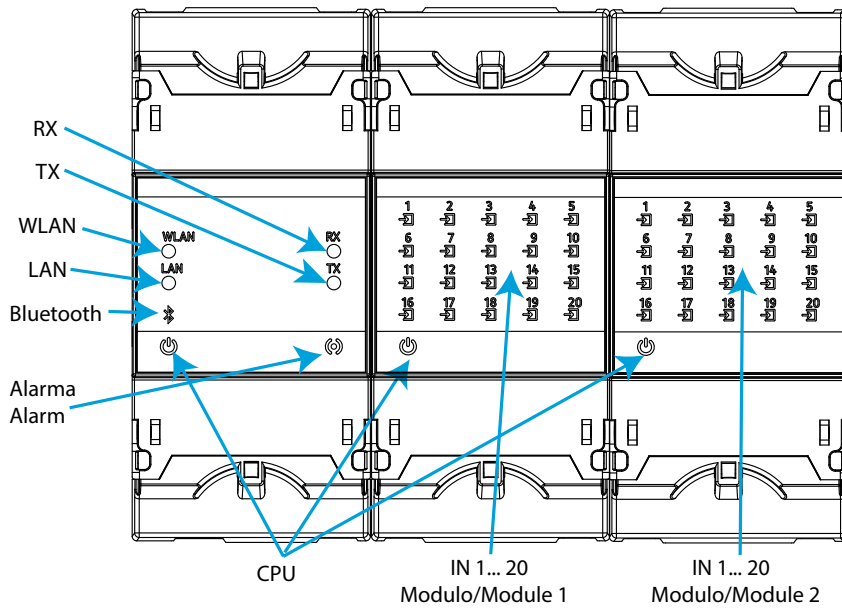

Figure 51: LEDs: line-LM40I-TCP kit.

The line-LM40I-TCP kit have 49 indicating LEDs:

✓ **CPU**, Indicates device status:

Table 64: LED CPU.

LED	Description
CPU	Flashing:
	<i>White:</i> Indicates that the device is powered

✓ **WLAN**, Indicates the status of Wi-Fi connectivity:

Table 65: LED WLAN.

LED	Description
WLAN	On:
	<i>Blue color:</i> Indicates that the Wi-Fi connection is activated

✓ **LAN**, Indicates the status of Ethernet connectivity:

Table 66: LED LAN.

LED	Description
LAN	On:
	<i>Green color:</i> Indicates that the Ethernet connection is activated

✓ **Bluetooth**, Indicates the status of Bluetooth® connectivity:

Table 67: LED Bluetooth.

LED	Description
Bluetooth	On:
	<i>Blue color:</i> Bluetooth® linked

- ✓ **RX, TX**, Indicates the status of RS-485 / RS-232 communications:

Table 68: LEDs RX and TX.

LED	Description
RX	Flashing:
	<i>Orange color:</i> Indicates the frame reception
TX	Flashing:
	<i>Orange color:</i> Indicates the frame delivery

- ✓ **Alarm**, Indicates that an alarm has been generated:

Table 69: LED Alarm.

LED	Description
Alarm	On:
	<i>Red color:</i> Frame reception error

- ✓ **IN x**, Indicates the status of digital input x:

Table 70: LED IN x.

LED	Description
IN x	On:
	<i>Green color:</i> Indicates that input x is activated

13.5.- MODBUS MEMORY MAP

The modbus memory map of the device is identical to that of the **line-M-20I** device, see section "**11.5 - MODBUS MEMORY MAP**".

13.6.- COMMUNICATIONS

13.6.1.- USAGE ENVIRONMENT AND HEALTH

See section "**9.3.1.- USAGE ENVIRONMENT AND HEALTH**".

13.6.2.- Wi-Fi COMMUNICATIONS

Wi-Fi is one of the most widespread wireless technologies today. It is used to connect electronic devices and exchange information between them without having to connect them physically.

The **line-LM40I-TCP kit** devices feature Wi-Fi communications in the 2.4GHz band, and are compliant with the IEEE 802.11b, IEEE 802.11g and IEEE 802.11n standards.

13.6.3.- Bluetooth® COMMUNICATIONS

The device features Bluetooth® wireless communication.

Bluetooth® is a short-range wireless technology that allows wireless data transfers between devices within a range of approximately 10 metres.

13.6.4.- CONFIGURATION WEBSITE

To access the internal configuration website, the device's IP address has to be entered into the browser address bar. The **line-LM40I-TCP kit** is set by default to DHCP mode.

The IP address can be obtained via Bluetooth® using the **MyConfig** application. The device can be identified by its MAC address using software such as *Advanced IP Scanner* or *IP Setup Program*.



See section *"10.4.4.- CONFIGURATION WEBSITE"*.

13.6.5.- MOBILE APP

The **MyConfig** mobile app, which can be used to set up Wi-Fi and Ethernet communications via Bluetooth®, can be downloaded free of charge from Google Play (Android).

13.7.- TECHNICAL FEATURES: line-LM40I-TCP kit

AC Power supply	
Rated voltage	80 ... 264 V~
Frequency	50 ... 60 Hz
Consumption	10.5 ... 14.5 VA
Installation category	CAT III 300V
DC Power supply	
Rated voltage	100 ... 300 V ===
Consumption	9 ... 9.5 W
Installation category	CAT III 300V
Digital inputs	
Quantity	40
Type	Optocoupler
Insulation	4.2 kV ===
Input impedance	1.4 kΩ
Consumption	60 mA inputs OFF 240 mA inputs ON
RS-485 interface	
Bus	RS-485
Baud rate	4800 - 9600 - 19200 - 38400 - 57600 - 115200 bps
Data bits	7 - 8
Stop bits	1 - 2
Parity	without - even - odd
RS-232 interface	
Bus	RS-232
Baud rate	4800 - 9600 - 19200 - 38400 - 57600 - 115200 bps
Data bits	7 - 8
Stop bits	1 - 2
Parity	without - even - odd

Ethernet Interface			
Type	Ethernet 10BaseT - 100BaseTX self-detectable		
Connector	RJ45		
Protocol	TCP - UDP - Modbus TCP - HTTP (Web server) - REST		
Connection mode to network	DHCP ON/OFF (ON by default)		
Wi-Fi communication			
Band	2.4 GHz (Range: 2.4 ... 2.5 GHz)		
Standard	IEEE 802.11 b / g , IEEE 802.11 n (up to 150 Mbps)		
Max. output power	IEEE 802.11 b: 20 dBm IEEE 802.11 n: 14 dBm		
Bluetooth® communication			
Protocols	Bluetooth® v4.2 BR/EDR and BLE specification		
Radio	NZIF receiver with -97 dBm sensitivity Class-1, class-2 and class-3 transmitter Adaptive Frequency Hopping (AFH) Receiver Sensitivity @30.8% PER -97 dBm Transmitter RF power control range Min: -12 dBm / Max: +12dBm		
User interface			
LED	49 LEDs		
Environmental features			
Operating temperature	-10°C ... +50°C		
Storage temperature	-20°C ... +70°C		
Relative humidity (non-condensing)	5 ... 95%		
Maximum altitude	2000 m		
Protection degree	IP30, Front: IP40		
Mechanical features			
Terminals			
1 ... 56	2.5 mm ²	≤ 0.4 Nm, M2.5	flat
Dimensions	Figure 52 (mm)		
Weight	430 g.		
Enclosure	Self-extinguishing V0 plastic		
Attachment	Carril DIN ⁽³¹⁾		
⁽³¹⁾ Recommended minimum distance between DIN rails: 150 mm.			
Standards			
Safety requirements for electrical equipment for measurement, control, and laboratory use Part 1: General requirements.	EN 61010-1		
Electromagnetic compatibility (EMC) Part 6-2: General standards. Immunity for industrial environments.	EN 61000-6-2		
Electromagnetic Compatibility (EMC) Part 6-4: General standards. Emission standard for industrial environments. (IEC 61000-6-4: 2006).	EN 61000-6-4		
Safety Requirements for Electrical Equipment for Measurement, Control, and Laboratory Use - Part 1: General Requirements	UL 61010-1		

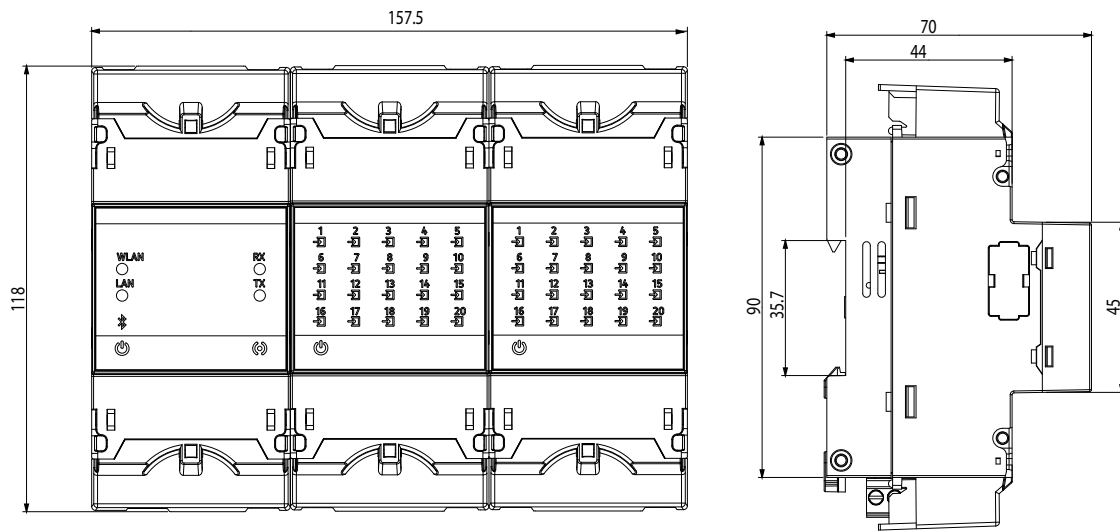

Figure 52: line-LM40I-TCP kit dimensions.

14.- MAINTENANCE AND TECHNICAL SERVICE

In the case of any query in relation to device operation or malfunction, please contact the **CIRCUTOR SA** Technical Support Service.

Technical Assistance Service

Vial Sant Jordi, s/n, 08232 - Viladecavalls (Barcelona)

Tel: 902 449 459 (España) / +34 937 452 919 (outside of Spain)

email: sat@circutor.com

15 .- GUARANTEE

CIRCUTOR guarantees its products against any manufacturing defect for two years after the delivery of the units.

CIRCUTOR will repair or replace any defective factory product returned during the guarantee period.



- No returns will be accepted and no unit will be repaired or replaced if it is not accompanied by a report indicating the defect detected or the reason for the return.
- The guarantee will be void if the units has been improperly used or the storage, installation and maintenance instructions listed in this manual have not been followed. "Improper usage" is defined as any operating or storage condition contrary to the national electrical code or that surpasses the limits indicated in the technical and environmental features of this manual.
- **CIRCUTOR** accepts no liability due to the possible damage to the unit or other parts of the installation, nor will it cover any possible sanctions derived from a possible failure, improper installation or "improper usage" of the unit. Consequently, this guarantee does not apply to failures occurring in the following cases:
 - Overvoltages and/or electrical disturbances in the supply;
 - Water, if the product does not have the appropriate IP classification;
 - Poor ventilation and/or excessive temperatures;
 - Improper installation and/or lack of maintenance;
 - Buyer repairs or modifications without the manufacturer's authorisation.

16.- CE CERTIFICATE



DECLARACIÓN UE DE CONFORMIDAD

La presente declaración de conformidad se expide bajo la exclusiva responsabilidad de CIRCUITOR con dirección en Vial Sant Jordi, s/n – 08232 Viladecavalls (Barcelona) España

Producto:

Energy Data Server

Serie:

Equipo/Device: line-EDS, line-CVM-D32

Módulo/Module: line-M-410-T, line-M-410-R, line-M-410-A, line-M-EXT-PS, line-M-201, line-M-3G, line-TCPRS1

Marca:

CIRCUITOR

EL objeto de la declaración es conforme con la legislación de armonización pertinente en la UE, siempre que sea instalado, mantenido y usado en la aplicación para la que ha sido fabricado, de acuerdo con las normas de instalación aplicables y las instrucciones del fabricante

2014/53/UE: Low Voltage Directive 2014/30/UE: EMC Directive 2011/65/UE + 2015/863/UE: RoHS Directive

Está en conformidad con la(s) siguiente(s) norma(s) u otro(s) documento(s) normativos(s):

IEC 61010-1:2010/AMD1:2016 Ed 3.0 IEC 61010-2-030:2010 Ed 1.0
IEC 61326-1:2012 Ed 2.0 IEC 61000-6-2:2016 Ed 3.0
IEC 61000-6-4:2018 Ed 3.0 ETSI EN 301 489-1 Ver. 2.1.1
ETSI EN 301 489-17 Ver. 3.2.1

Año de marcado "CE":

2020



EU DECLARATION OF CONFORMITY

This declaration of conformity is issued under the sole responsibility of CIRCUITOR with registered address at Vial Sant Jordi, s/n – 08232 Viladecavalls (Barcelona) Spain

Product:

Energy Data Server

Series:

Equipo/Device: line-EDS, line-CVM-D32

Módulo/Module: line-M-410-T, line-M-410-R, line-M-410-A, line-M-EXT-PS, line-M-201, line-M-3G, line-TCPRS1

Brand:

CIRCUITOR

The object of the declaration is in conformity with the relevant EU harmonisation legislation, provided that it is installed, maintained and used for the application for which it was manufactured, in accordance with the applicable installation standards and the manufacturer's instructions.

2014/53/UE: Low Voltage Directive 2014/30/UE: EMC Directive 2011/65/UE + 2015/863/UE: RoHS Directive

It is in conformity with the following standard(s) or other regulatory document(s):

IEC 61010-1:2010/AMD1:2016 Ed 3.0 IEC 61010-2-030:2010 Ed 1.0
IEC 61326-1:2012 Ed 2.0 IEC 61000-6-2:2016 Ed 3.0
IEC 61000-6-4:2018 Ed 3.0 ETSI EN 301 489-1 Ver. 2.1.1
ETSI EN 301 489-17 Ver. 3.2.1

Year of CE mark:

2020



DECLARATION UE DE CONFORMITÉ

La présente déclaration de conformité est délivrée sous la responsabilité exclusive de CIRCUITOR dont l'adresse postale est Vial Sant Jordi, s/n – 08232 Viladecavalls (Barcelona) Espagne

Produit:

Energy Data Server

Série:

Equipo/Device: line-EDS, line-CVM-D32

Módulo/Module: line-M-410-T, line-M-410-R, line-M-410-A, line-M-EXT-PS, line-M-201, line-M-3G, line-TCPRS1

Marque:

CIRCUITOR

L'objet de la déclaration est conforme à la législation d'harmonisation pertinente dans l'UE, à condition d'avoir été installé, entretenu et utilisé dans l'application pour laquelle il a été fabriqué, conformément aux normes d'installation applicables et aux instructions du fabricant

2014/53/UE: Low Voltage Directive 2014/30/UE: EMC Directive 2011/65/UE + 2015/863/UE: RoHS Directive

Il est en conformité avec la(les) suivante(s) norme(s) ou autre(s) document(s) réglementaire(s):

IEC 61010-1:2010/AMD1:2016 Ed 3.0 IEC 61010-2-030:2010 Ed 1.0
IEC 61326-1:2012 Ed 2.0 IEC 61000-6-2:2016 Ed 3.0
IEC 61000-6-4:2018 Ed 3.0 ETSI EN 301 489-1 Ver. 2.1.1
ETSI EN 301 489-17 Ver. 3.2.1

Année de marquage « CE »:

2020

Viladecavalls (Spain), 11/9/2020
General Manager: Ferran Gil Torné



CIRCUITOR, SA – Vial Sant Jordi, s/n
08232 Viladecavalls (Barcelona) Spain
(+34) 937 452 900 – info@circuitor.com



KONFORMITÄTSERKLÄRUNG UE

Vorliegende Konformitätserklärung wird unter alleiniger Verantwortung von CIRCUITOR mit der Anschrift, Vial Sant Jordi, s/n – 08232 Viladecavalls (Barcelona) Spanien, ausgestellt

Produkt:

Energy Data Server

Série:

Equipo/Device: line-EDS, line-CVM-D32

Módulo/Module: line-M-410-T, line-M-410-R, line-M-410-A, line-M-EXT-PS, line-M-20I, line-M-3G, line-TCPRS1

Marke:

CIRCUITOR

Der Gegenstand der Konformitätserklärung ist konform mit der geltenden Gesetzgebung zur Harmonisierung der EU, sofern die Installation, Wartung und Verwendung der Anwendung seinem Verwendungszweck entsprechend gemäß den geltenden Installationsstandards und der Vorarbeiten des Herstellers erfolgt.

2014/35/UE: Low Voltage Directive 2014/30/UE: EMC Directive
2014/53/UE: RED Directive 2011/65/UE: RoHS Directive

Es besteht Konformität mit der/den folgender/folgenden Norm/Normen oder sonstigem/sonstiger

Regelwerk/Regelwerken IEC 61010-2-030:2010 Ed 1.0
IEC 61010-1:2010-AMD1:2016 Ed 3.0 IEC 61000-6-2:2016 Ed 3.0
IEC 61326-1:2012 Ed 2.0 IEC 61000-6-2:2016 Ed 3.0
IEC 61000-6-4:2018 Ed 3.0 ETSI EN 301 489-1 Ver. 2.1.1
ETSI EN 301 489-17 Ver. 3.2.1

Jahr der CE-Kennzeichnung:

2020



DECLARAÇÃO DA UE DE CONFORMIDADE

A presente declaração de conformidade é expedida sob a exclusiva responsabilidade da CIRCUITOR com morada em Vial Sant Jordi, s/n – 08232 Viladecavalls (Barcelona) Espanha

Produto:

Energy Data Server

Série:

Equipo/Device: line-EDS, line-CVM-D32

Módulo/Module: line-M-410-T, line-M-410-R, line-M-410-A, line-M-EXT-PS, line-M-20I, line-M-3G, line-TCPRS1

Marca:

CIRCUITOR

O objeto da declaração está conforme a legislação de harmonização pertinente na UE, sempre que seja instalado, mantido e utilizado na aplicação para a qual foi fabricado, de acordo com as normas de instalação aplicáveis e as instruções do fabricante.

2014/35/UE: Low Voltage Directive 2014/30/UE: EMC Directive
2014/53/UE: RED Directive 2011/65/UE: RoHS Directive

Está em conformidade com a(s) seguinte(s) norma(s) ou outro(s) documento(s) normativo(s):

IEC 61010-2-030:2010 Ed 1.0 IEC 61010-1:2010-AMD1:2016 Ed 3.0 IEC 61000-6-2:2016 Ed 3.0
IEC 61326-1:2012 Ed 2.0 IEC 61000-6-2:2016 Ed 3.0
IEC 61000-6-4:2018 Ed 3.0 ETSI EN 301 489-1 Ver. 2.1.1
ETSI EN 301 489-17 Ver. 3.2.1

Ano de marcação "CE":

2020



DICHIARAZIONE DI CONFORMITÀ UE

La presente dichiarazione di conformità viene rilasciata sotto la responsabilità esclusiva di CIRCUITOR, con sede in Vial Sant Jordi, s/n – 08232 Viladecavalls (Barcelona) Spagna prodotto:

Energy Data Server

Serie:

Equipo/Device: line-EDS, line-CVM-D32

Módulo/Module: line-M-410-T, line-M-410-R, line-M-410-A, line-M-EXT-PS, line-M-20I, line-M-3G, line-TCPRS1

MARCHIO:

CIRCUITOR

L'oggetto della dichiarazione è conforme alla pertinente normativa di armonizzazione dell'Unione Europea, a condizione che venga installato, mantenuto e utilizzato nell'ambito dell'applicazione per cui è stato prodotto, secondo le norme di installazione applicabili e le istruzioni del produttore.

2014/35/UE: Low Voltage Directive 2014/30/UE: EMC Directive
2014/53/UE: RED Directive 2011/65/UE: RoHS Directive

È conforme alle seguenti normative o altri documenti normativi:

IEC 61010-2-030:2010 Ed 3.0 IEC 61010-1:2010-AMD1:2016 Ed 3.0 IEC 61000-6-2:2016 Ed 3.0
IEC 61326-1:2012 Ed 2.0 IEC 61000-6-2:2016 Ed 3.0
IEC 61000-6-4:2018 Ed 3.0 ETSI EN 301 489-1 Ver. 2.1.1
ETSI EN 301 489-17 Ver. 3.2.1

Anno di marcatura "CE":

2020

Viladecavalls (Spain), 11/3/2020
General Manager: Ferran Gil Torné



CIRCUITOR, SA – Vial Sant Jordi, s/n
08232 Viladecavalls (Barcelona) Spain
(+34) 937 452 900 – info@circuitor.com



DEKLARACJA ZGODNOSCI UE

Niniejsza deklaracja zgodności zostaje wydana na wyłączną odpowiedzialność firmy CIRCUITOR z siedzibą pod adresem: Vial Sant Jordi, s/n – 08232 Viladecavalls (Barcelona) Hiszpania

produkt:

Energy Data Server

Seria:

Equipo/Device: line-EDS, line-CVM-D32

Módulo/Module: line-M-410-T, line-M-410-R, line-M-410-A,
line-M-EXT-PS, line-M-201, line-M-3G, line-TCPRS1

marka:

CIRCUITOR

Przedmiot deklaracji jest zgodny z odnoszonymi wymaganiami prawodawstwa harmonizacyjnego w Unii Europejskiej pod warunkiem, że będzie instalowany, konserwowany i użytkowany zgodnie z przeznaczeniem, dla którego został wyprodukowany, zgodnie z mającymi zastosowanie normami dotyczącymi instalacji oraz instrukcjami producenta

2014/53/UE: Low Voltage Directive 2014/30/UE: EMC Directive
2011/65/UE: RoHS Directive 2015/863/UE: RoHS Directive

Jest zgodny z następującą(y) normą(ami) lub innym(i) dokumentem(ami) normatywnym(i):
IEC 61010-1:2010/AMD1:2016 Ed 3.0 IEC 61010-2-030:2010 Ed 1.0
IEC 61326-1:2012 Ed 2.0 IEC 61000-6-2:2016 Ed 3.0
IEC 61000-6-4:2018 Ed 3.0 ETSI EN 301 489-1 Ver. 2.1.1
ETSI EN 301 489-17 Ver. 3.2.1

Rok oznakowania "CE":

2020

Viladecavalls (Spain), 11/3/2020
General Manager: Ferran Gil Torné



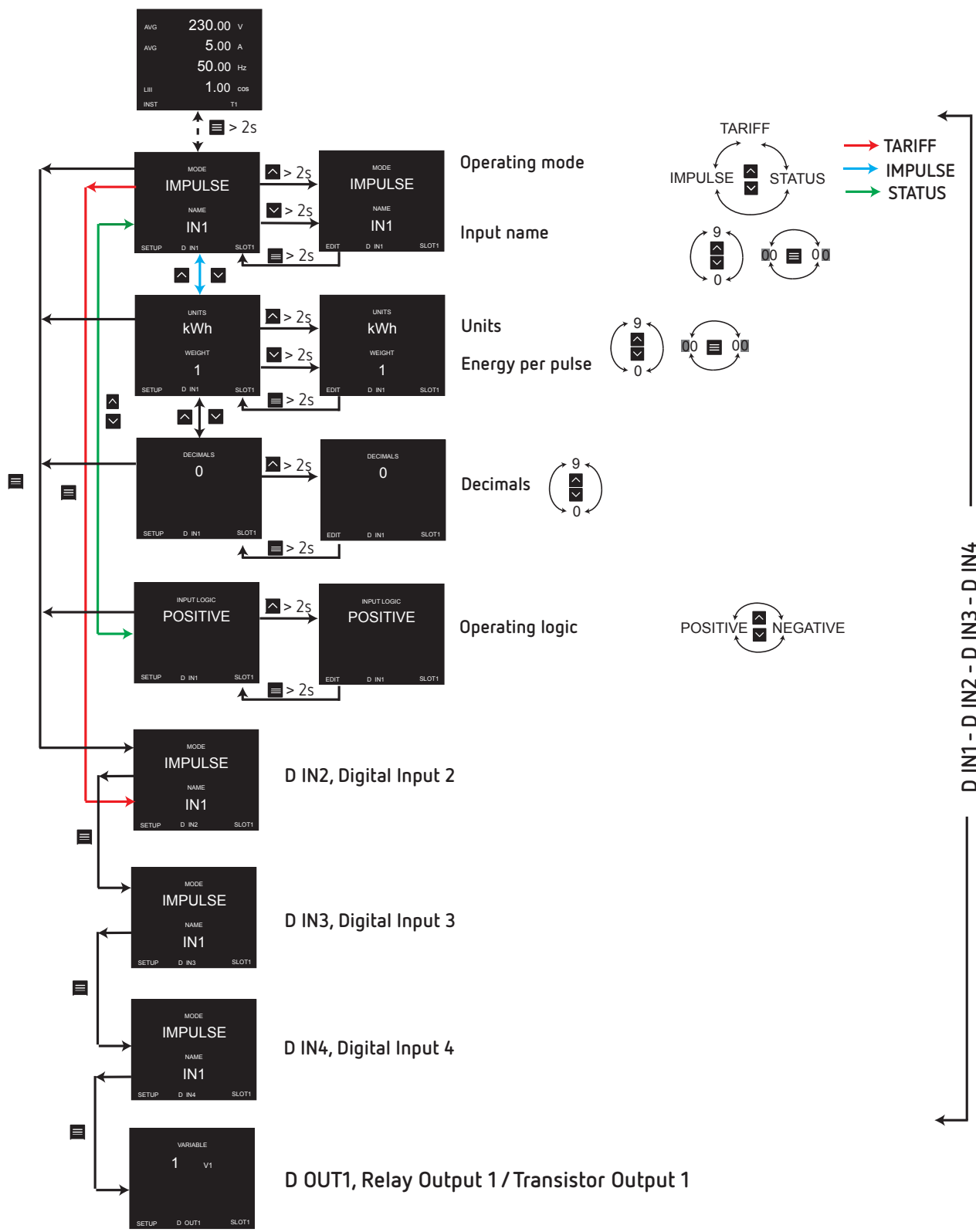

ANNEX A.- CONFIGURATION MENUS

A.1.- line-M-4IO-R, line-M-4IO-T and line-M-4IO-RV

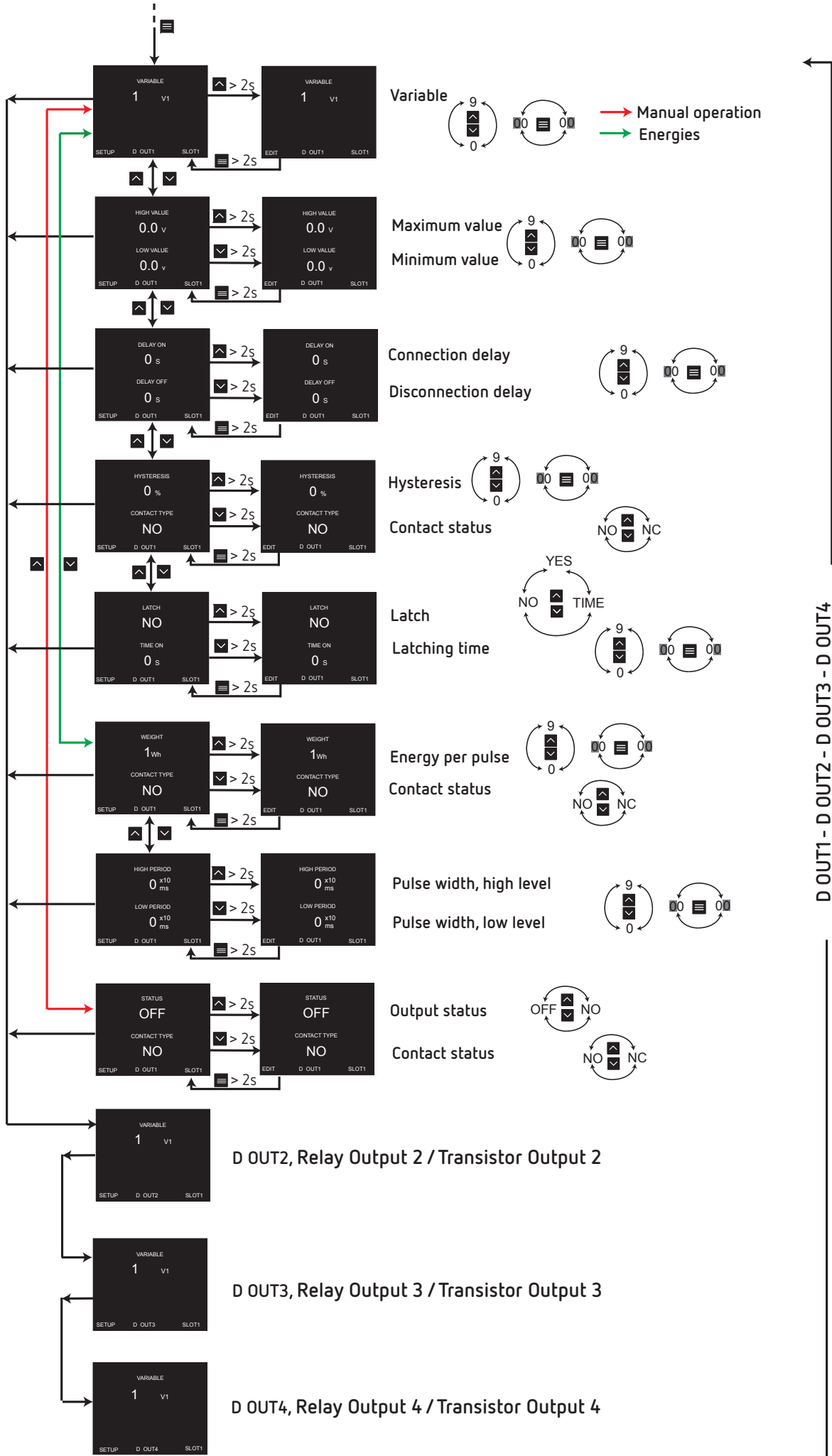

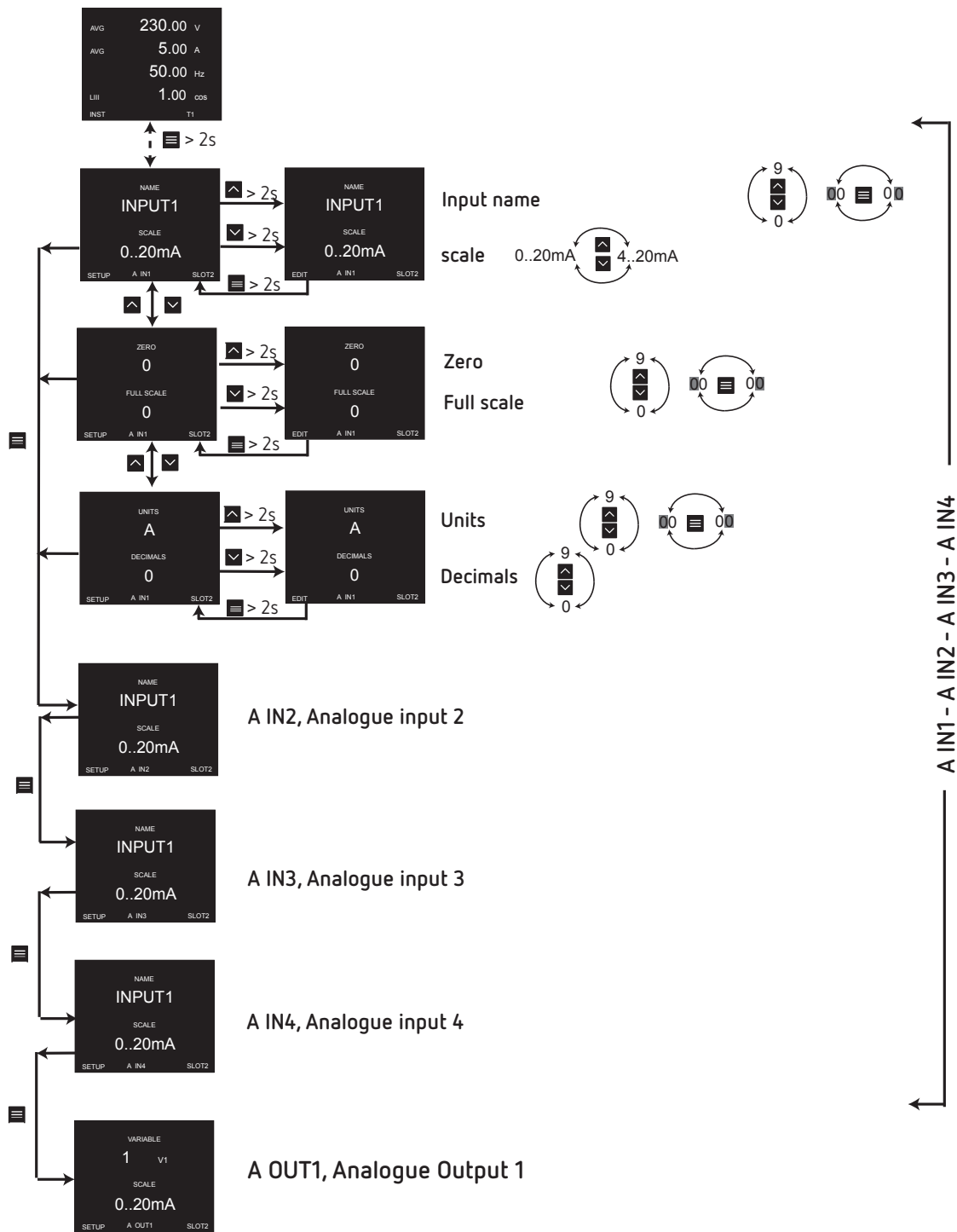

A.2.- line-M-4IO-A



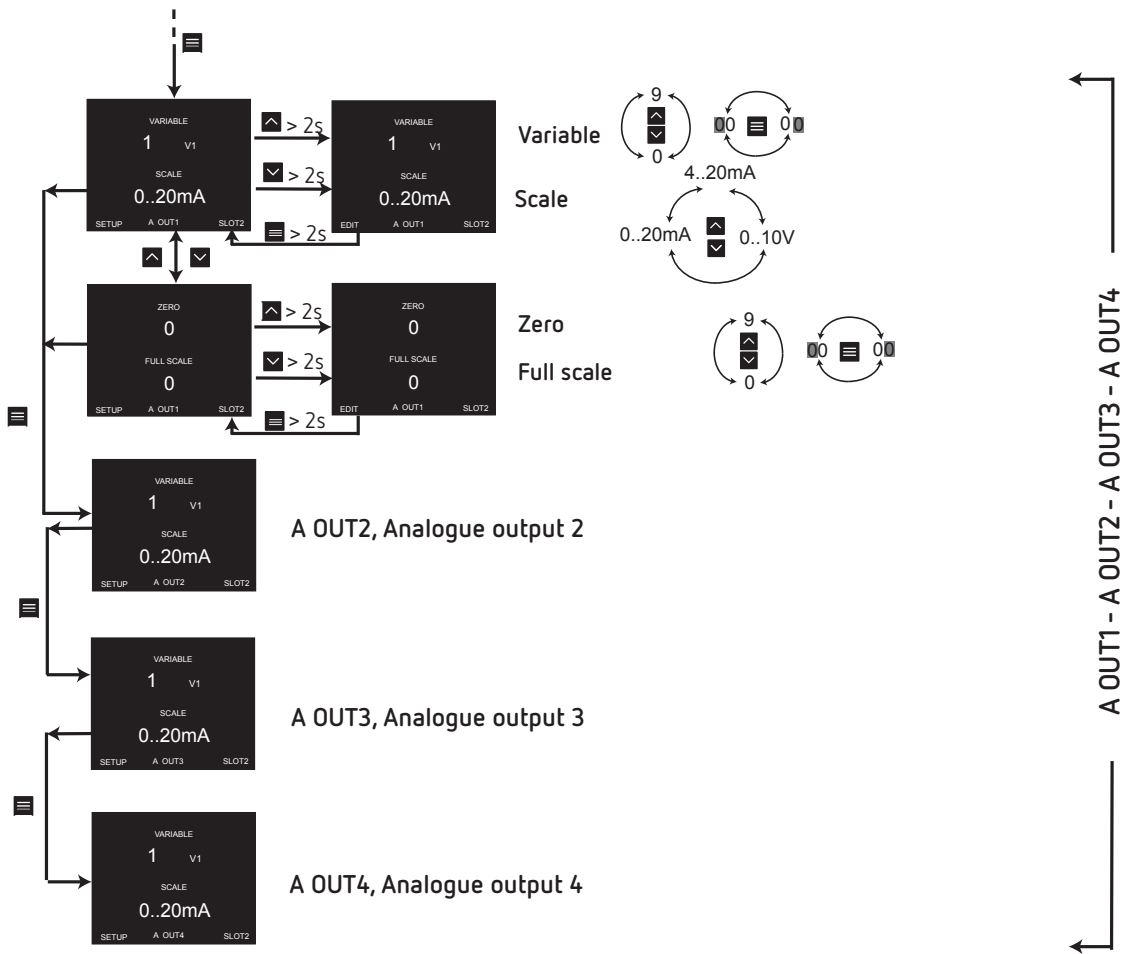

CIRCUTOR, SA

Vial Sant Jordi, s/n

08232 - Viladecavalls (Barcelona)

Tel: (+34) 93 745 29 00 - Fax: (+34) 93 745 29 14

www.circutor.es central@circutor.com