

1825612-3 ✓ ACTIVE

[Alcoswitch](#) | [Alcoswitch FCR](#)

TE Internal #: 1825612-3

Alcoswitch FCR, Switch Boots & Accessories, Toggle Switch Boot Seal, Toggle Switch, Round Style, Gray

[View on TE.com >](#)



Relays, Contactors & Switches > Switches > Hardware & Seals

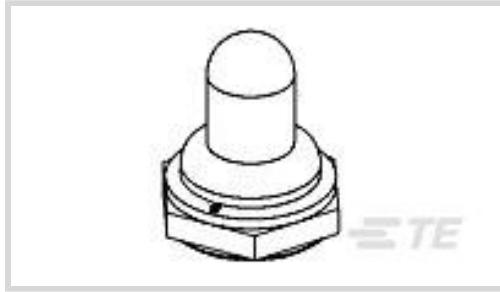

Switch Boot Accessory Type: **Toggle Switch Boot Seal**

Switch Boot & Accessory For Use With: **Toggle Switch**

Style: **Round**

Switch Boot & Accessory Color: **Gray**

Features

Product Type Features

Product Type	Accessory
Illuminated	No
Switch Boot Accessory Type	Toggle Switch Boot Seal
Style	Round

Configuration Features

Tactile	No
---------	----

Body Features

Boot Color	Black
Seal Type	Boot
Finish	Nickel
Switch Boot & Accessory Color	Gray

Mechanical Attachment

Screw & Hole Thread Size	1/4 – 40 UNS-2B
--------------------------	-----------------

Housing Features

Process Sealed	No
----------------	----

Usage Conditions

Oil-Tight	No
-----------	----

Operation/Application

Switch Boot & Accessory For Use With	Toggle Switch
--------------------------------------	---------------



Packaging Features

Packaging Method	Bag/Box
------------------	---------

Product Compliance

[For compliance documentation, visit the product page on TE.com>](#)

EU RoHS Directive 2011/65/EU	Compliant with Exemptions
EU ELV Directive 2000/53/EC	Compliant with Exemptions
China RoHS 2 Directive MIIT Order No 32, 2016	Restricted Materials Above Threshold
EU REACH Regulation (EC) No. 1907/2006	Current ECHA Candidate List: JAN 2021 (211) Candidate List Declared Against: JUN 2018 (191) SVHC > Threshold: Pb (1.36% in Component Part) Article Safe Usage Statements: Do not eat, drink or smoke when using this product. Wash thoroughly after handling. Recycle if possible and dispose of the article by following all applicable governmental regulations relevant to your geographic location.
Halogen Content	Low Halogen - Br, Cl, F, I < 900 ppm per homogenous material. Also BFR/CFR/PVC Free
Solder Process Capability	Not reviewed for solder process capability

Product Compliance Disclaimer

This information is provided based on reasonable inquiry of our suppliers and represents our current actual knowledge based on the information they provided. This information is subject to change. The part numbers that TE has identified as EU RoHS compliant have a maximum concentration of 0.1% by weight in homogenous materials for lead, hexavalent chromium, mercury, PBB, PBDE, DBP, BBP, DEHP, DIBP, and 0.01% for cadmium, or qualify for an exemption to these limits as defined in the Annexes of Directive 2011/65/EU (RoHS2). Finished electrical and electronic equipment products will be CE marked as required by Directive 2011/65/EU. Components may not be CE marked. Additionally, the part numbers that TE has identified as EU ELV compliant have a maximum concentration of 0.1% by weight in homogenous materials for lead, hexavalent chromium, and mercury, and 0.01% for cadmium, or qualify for an exemption to these limits as defined in the Annexes of Directive 2000/53/EC (ELV). Regarding the REACH Regulation, the information TE provides on SVHC in articles for this part number is based on the latest European Chemicals Agency (ECHA) 'Guidance on requirements for substances in articles' posted at this URL: <https://echa.europa.eu/guidance-documents/guidance-on-reach>

Compatible Parts



Also in the Series | Alcoswitch FCR

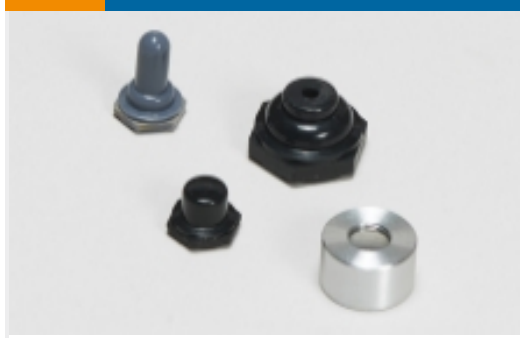

Switch Boots & Accessories(15)

Customers Also Bought



TE Part #2337227-1
TACT ULTRA JB 3.0X2.6X0.45 100GF

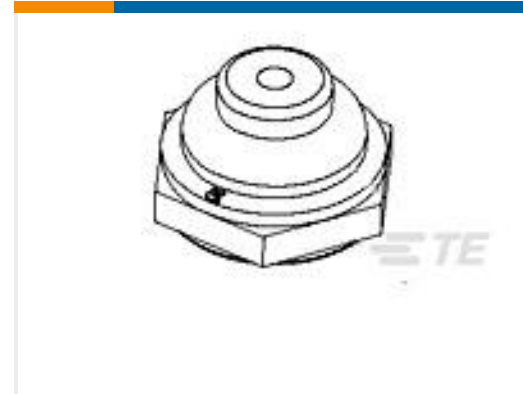

TE Part #1825619-1
BT1440004=Boot,Toggle



TE Part #1-1618276-2
K61A841=RELAY, PRESSURIZED, SP

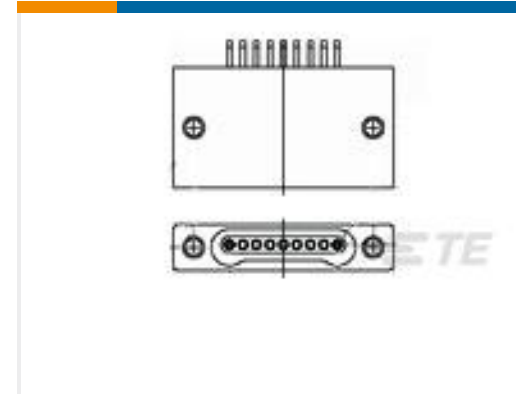

TE Part #2-1589462-1
SSM005L2HN = SMT CONN



TE Part #449690-1
LGH-1 BULKHEAD RECEPT.

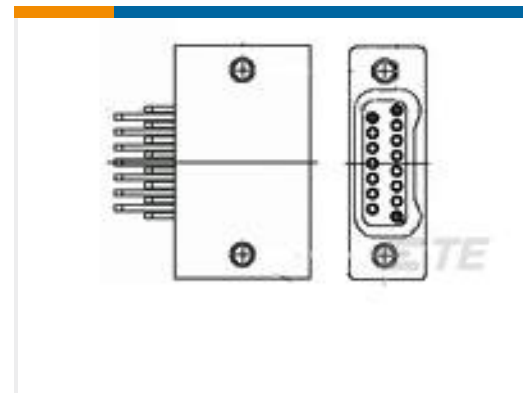

TE Part #3-1589483-6
STM015L2HN = SMT CONN

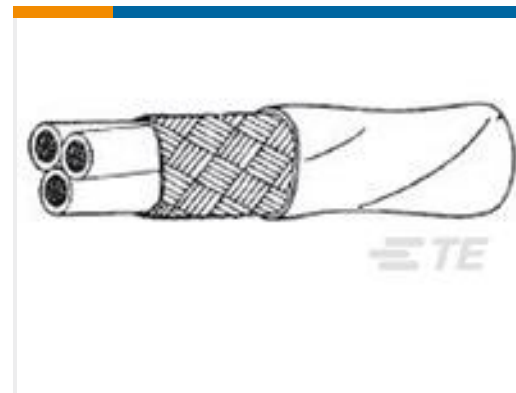

TE Part #492235-003
55A1131-26-0/2/9-9



TE Part #YAFD57-14-12SNC012
PLUG ASSY



TE Part #2-1618273-9
H-18=RELAY, VACUUM, DPDT

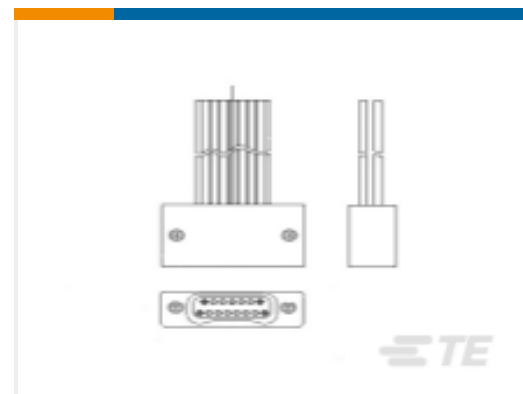

TE Part #4-1589476-6
STM009SC2DC012N = WDUALOBE

Documents

Product Drawings

B1440804=Boot,Toggle

English