

2-5330358-2 ✓ ACTIVE

TE Internal #: 2-5330358-2

RF Connectors, BNC RF Interface, Plug, RF Connector Mated Outer

Diameter (Approximate) .572 in [14.53 mm], 50 Ω

[View on TE.com >](#)



Connectors > RF Coax Connectors > RF Connectors > BNC RF Connector: Plug Kit, Straight, 4 GHz, Military Grade



RF Interface: **BNC**

RF Connector Style: **Plug**

RF Connector Mated Outer Diameter (Approximate): **14.53 mm [ .572 in ]**

Impedance: **50 Ω**

Compatible With RF Cable Type: **RG 142, RG 142A, RG 142B**

[All BNC RF Connector: Plug Kit, Straight, 4 GHz, Military Grade \(11\)](#)

## Features

### Product Type Features

RF Interface	BNC
RF Connector Style	Plug
Compatible With RF Cable Type	RG 142, RG 142A, RG 142B
Connector System	Cable-to-Cable
Sealable	Yes
Connector & Contact Terminates To	Wire & Cable
Connector Seal Type	Gasket

### Configuration Features

Number of Positions	1
Number of Coaxial Contacts	1

### Electrical Characteristics

Impedance	50 Ω
-----------	------

### Body Features

Body Insulation	Without
Cable Connector Orientation	Straight
Body Material	Brass
Body Plating Material	Silver

### Contact Features



RF Connector Center Contact Underplating Material	Nickel
	889 $\mu$ m
Crimp Type	Single
RF Connector Center Contact Plating Material	Gold
RF Connector Center Contact Material	Brass

### Termination Features

Termination Method to Wire & Cable	Crimp
------------------------------------	-------

### Mechanical Attachment

Mating Retention Type	Threaded
RF Connector Coupling Mechanism	Bayonet
RF Contact Captivation Method	Mechanical
Detent	With

### Dimensions

RF Connector Mated Outer Diameter (Approximate)	14.53 mm[.572 in]
---	-------------------

### Usage Conditions

Operating Temperature Range	-55 – 85 °C[-67 – 185 °F]
-----------------------------	---------------------------

### Operation/Application

Operating Frequency	4 GHz
---------------------	-------

### Packaging Features

Packaging Method	Carton
------------------	--------

### Other

Grade	Military
Coupling Nut Base Material	Brass
Dielectric Material	PTFE

### Product Compliance

[For compliance documentation, visit the product page on TE.com>](#)

EU RoHS Directive 2011/65/EU	Compliant with Exemptions
EU ELV Directive 2000/53/EC	Compliant with Exemptions
China RoHS 2 Directive MIIT Order No 32, 2016	Restricted Materials Above Threshold
EU REACH Regulation (EC) No. 1907/2006	Current ECHA Candidate List: JAN 2021 (211)



Candidate List Declared Against: JAN 2021 (211)

SVHC > Threshold:

Pb (3.7% in Component Part)

**Article Safe Usage Statements:**

Do not eat, drink or smoke when using this product. Wash thoroughly after handling. Recycle if possible and dispose of the article by following all applicable governmental regulations relevant to your geographic location.

Halogen Content

BFR/CFR/PVC Free, but Br/Cl >900 ppm in other sources.

Solder Process Capability

Not applicable for solder process capability

**Product Compliance Disclaimer**

This information is provided based on reasonable inquiry of our suppliers and represents our current actual knowledge based on the information they provided. This information is subject to change. The part numbers that TE has identified as EU RoHS compliant have a maximum concentration of 0.1% by weight in homogenous materials for lead, hexavalent chromium, mercury, PBB, PBDE, DBP, BBP, DEHP, DIBP, and 0.01% for cadmium, or qualify for an exemption to these limits as defined in the Annexes of Directive 2011/65/EU (RoHS2). Finished electrical and electronic equipment products will be CE marked as required by Directive 2011/65/EU. Components may not be CE marked. Additionally, the part numbers that TE has identified as EU ELV compliant have a maximum concentration of 0.1% by weight in homogenous materials for lead, hexavalent chromium, and mercury, and 0.01% for cadmium, or qualify for an exemption to these limits as defined in the Annexes of Directive 2000/53/EC (ELV). Regarding the REACH Regulation, the information TE provides on SVHC in articles for this part number is based on the latest European Chemicals Agency (ECHA) 'Guidance on requirements for substances in articles' posted at this URL: <https://echa.europa.eu/guidance-documents/guidance-on-reach>

## Compatible Parts



TE Part # CAT-076-BNCPK2GMG  
BNC RF Connector: Plug Kit, Straight, 2 GHz, Military Grade



TE Part # CAT-076-BNCPK4GMG  
BNC RF Connector: Plug Kit, Straight, 4 GHz, Military Grade



TE Part # CAT-076-BNCVTBAY  
BNC Vertical Male (Jack) RF Connector, 50 Ohm, Bayonet Coupling Mechanism



TE Part # 5225395-1  
BNC PLUG DUAL CRIMP RG58,A,B,C



TE Part # 5227426-1  
BNC BLKHD RECPT SEALED



TE Part # 5227079-5  
COMM BNC PLUG





TE Part # 5225398-7  
BNC DUAL CRIMP JACJ



TE Part # 1-5221128-0  
PLUG,COMMERCIAL BNC

 <p>TE Part # 1-5225398-5 DUAL CRIMP BNC BLKHD JACK</p>	 <p>TE Part # 5225395-7 BNC PLUG DUAL CRIMP RG174,188</p>	 <p>TE Part # 5225395-6 BNC PLUG DUAL CP RG142</p>	 <p>TE Part # 8-5227079-2 COMM BNC PLUG</p>
 <p>TE Part # 330876 BNC PLUG</p>	 <p>TE Part # 1058016-1 3252 1201 10</p>	 <p>TE Part # 2-5330061-1 BNC PLUG</p>	 <p>TE Part # 225974-1 PLUG, RT ANGLE, DUAL CRIMP BNC</p>
 <p>TE Part # 5221198-1 JACK,VERT,PCB,TWIN BNC</p>	 <p>TE Part # 5225395-8 BNC PLUG DUAL CRIMP RG179, 187</p>	 <p>TE Part # 5225396-1 BNC JACK DUAL CP RG58,A,B,C</p>	 <p>TE Part # 5225396-7 BNC JACK DUAL CP RG174,188</p>

### Customers Also Bought

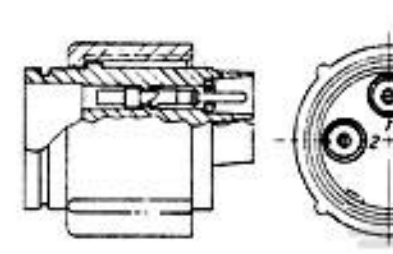
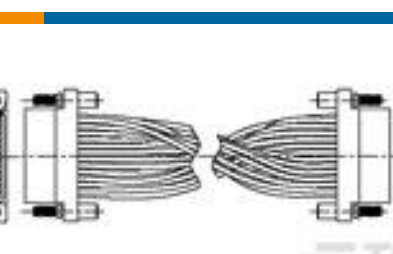
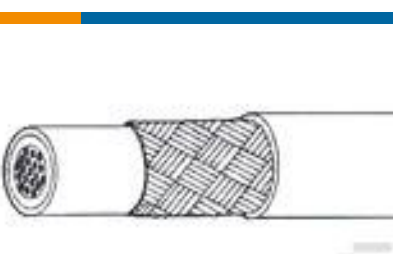
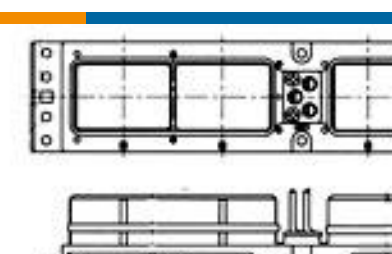
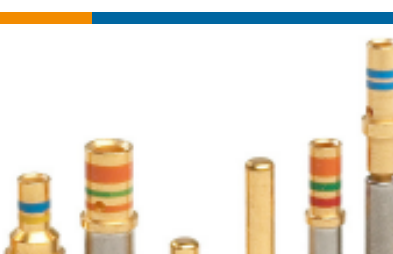
 <p>TE Part #819601-000 Heat Shrink Boots: Non Lipped, Straight</p>	 <p>TE Part #748703-000 B-500-02-105</p>	 <p>TE Part #425030-000 HEX40-AC-45-23-A13-1</p>	 <p>TE Part #863021-2 PLUG ASSY, 3 PIN</p>
 <p>TE Part #4-1589737-3 JTL025PP2DC001M = WDUALOBE</p>	 <p>TE Part #739053-000 44AM1111-14-9-9CS2275</p>	 <p>TE Part #449838-1 NIC66H21A AA CONN ASSY</p>	 <p>TE Part #ZPF0000000000003649 724-8021-22</p>

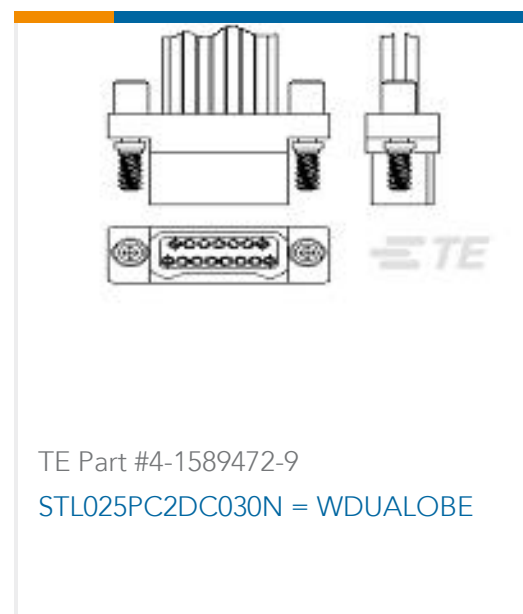

## Documents

### Product Drawings

#### BNC PLUG KIT

English

### CAD Files

#### 3D PDF

3D

#### Customer View Model

[ENG\\_CVM\\_CVM\\_2-5330358-2\\_A.2d\\_dxf.zip](#)

English

#### Customer View Model

[ENG\\_CVM\\_CVM\\_2-5330358-2\\_A.3d\\_igs.zip](#)

English

#### Customer View Model

[ENG\\_CVM\\_CVM\\_2-5330358-2\\_A.3d\\_stp.zip](#)

English

By downloading the CAD file I accept and agree to the [Terms and Conditions](#) of use.

### Datasheets & Catalog Pages

#### BNC Connectors

English

### Agency Approvals

#### UL Report

English