

1-643075-3 ✓ ACTIVE

MTA | MTA 100

TE Internal #: 1-643075-3

MTA 100, PCB Connector Covers, Strain Relief Covers, 13 Position,
2.54mm [.1in] Centerline, Nylon, Standard Product Profile

[View on TE.com >](#)



Connectors > PCB Connectors > PCB Connector Accessories > Protection & Strain Relief > PCB Connector Covers >

Nylon PCB Connector Covers: 2.54mm, MTA 100



Protection & Strain Relief Accessory Type: **Strain Relief Covers**

Number of Positions: **13**

Centerline (Pitch): **2.54 mm [.1 in]**

Primary Product Material: **Nylon**

Product Profile: **Standard**

[All Nylon PCB Connector Covers: 2.54mm, MTA 100 \(54\)](#)

Features

Product Type Features

Protection & Strain Relief Accessory Type	Strain Relief Covers
Product Profile	Standard

Configuration Features

Number of Positions	13
---------------------	----

Body Features

Primary Product Color	White
Primary Product Material	Nylon

Housing Features

Centerline (Pitch)	2.54 mm[.1 in]
--------------------	----------------

Usage Conditions

Compatible With IDC Installation Type Connector	Closed End
Operating Temperature Range	-40 – 85 °C[-40 – 185 °F][-40 – 185 °F]



Industry Standards

UL Flammability Rating	UL 94V-2
------------------------	----------

Product Compliance

[For compliance documentation, visit the product page on TE.com>](#)

EU RoHS Directive 2011/65/EU	Compliant
EU ELV Directive 2000/53/EC	Compliant
China RoHS 2 Directive MIIT Order No 32, 2016	No Restricted Materials Above Threshold
EU REACH Regulation (EC) No. 1907/2006	Current ECHA Candidate List: JAN 2021 (211) Candidate List Declared Against: JAN 2021 (211) Does not contain REACH SVHC
Halogen Content	Low Halogen - Br, Cl, F, I < 900 ppm per homogenous material. Also BFR/CFR/PVC Free
Solder Process Capability	Not applicable for solder process capability

Product Compliance Disclaimer

This information is provided based on reasonable inquiry of our suppliers and represents our current actual knowledge based on the information they provided. This information is subject to change. The part numbers that TE has identified as EU RoHS compliant have a maximum concentration of 0.1% by weight in homogenous materials for lead, hexavalent chromium, mercury, PBB, PBDE, DBP, BBP, DEHP, DIBP, and 0.01% for cadmium, or qualify for an exemption to these limits as defined in the Annexes of Directive 2011/65/EU (RoHS2). Finished electrical and electronic equipment products will be CE marked as required by Directive 2011/65/EU. Components may not be CE marked. Additionally, the part numbers that TE has identified as EU ELV compliant have a maximum concentration of 0.1% by weight in homogenous materials for lead, hexavalent chromium, and mercury, and 0.01% for cadmium, or qualify for an exemption to these limits as defined in the Annexes of Directive 2000/53/EC (ELV). Regarding the REACH Regulation, the information TE provides on SVHC in articles for this part number is based on the latest European Chemicals Agency (ECHA) 'Guidance on requirements for substances in articles' posted at this URL: <https://echa.europa.eu/guidance-documents/guidance-on-reach>

Compatible Parts

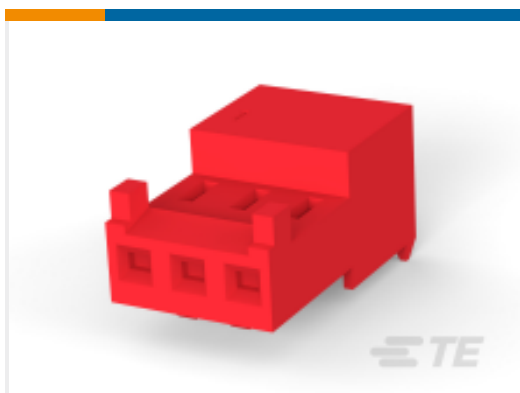

TE Part # CAT-104MTA-NTPMR
Nylon Tin Plated Receptacle: 2.54mm, With Mating Alignment, MTA 100



TE Part # CAT-104MTA-NYLCC
Nylon PCB Connector Covers: 2.54 mm, MTA 100

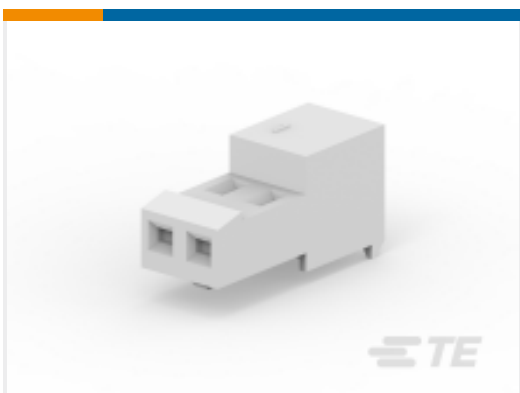

TE Part # CAT-104MTA-NTPNR
Nylon Tin Plated Receptacle: 2.54mm, No Mating Alignment, MTA 100



TE Part # CAT-104MTA-PRUSH
Polyester Right Angle PCB Header: 2.54mm, Unshrouded, MTA 100





TE Part # CAT-104CST-RCPHS
Receptacle Housing: 2.54mm, 1 Row, CST-100 II



TE Part # CAT-104MTA-PVUNH
Polyester Vertical PCB Header: 2.54 mm, Unshrouded, No Mating Alignment

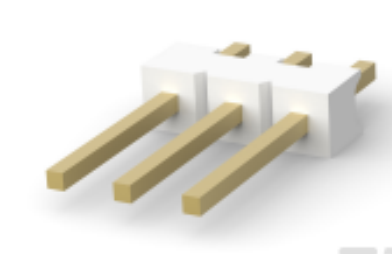

TE Part # CAT-104MTA-PVUMH
Polyester Vertical PCB Header: 2.54 mm, With Mating Alignment, Unshrouded



TE Part # CAT-104MTA-PVBRH
Polyester Vertical PCB Header: 2.54 mm, Breakaway, MTA 100



TE Part # CAT-104MTA-NGPNR
Nylon Gold Plated Receptacle: 2.54 mm, No Mating Alignment, MTA 100



TE Part # CAT-104MTA-PRUMH
Polyester Right Angle PCB Header: 2.54mm, Wire-to-Board, MTA 100



TE Part # CAT-104MTA-PVSHH
Polyester Vertical PCB Header: 2.54 mm, Shrouded, MTA 100



TE Part # CAT-104MTA-NGPMR
Nylon Gold Plated Receptacle: 2.54 mm, With Mating Alignment, MTA 100



TE Part # CAT-104MTA-PRSMH
Polyester Right Angle PCB Header: 2.54mm, Shrouded, With Mating Alignment



TE Part # CAT-104MTA-PRBRH
Polyester Right Angle PCB Header: 2.54mm, Breakaway, MTA 100



TE Part # CAT-104MTA-NTPMP
Nylon Tin Plated Plug: 2.54mm, With Mating Alignment, MTA 100



TE Part # CAT-104MTA-NGPMP
Nylon Gold Plated Plug: 2.54mm, With Mating Alignment, MTA 100



TE Part # 4-644892-3
13P CST100 SHRD HDR ASSY LF



TE Part # 4-644893-3
13P CST100 SHRD HDR ASSY LF



TE Part # 4-644894-3
13P CST100 SHRD HDR ASSY LF



TE Part # 4-644896-3
13P CST100 SHRD HDR ASSY LF

Also in the Series | **MTA 100**



Insertion & Extraction Tools(2)



PCB Connector Covers(107)



PCB Connector Keying(1)



Standard Rectangular Connectors (1730)



Wire-to-Board Connector Contacts(18)

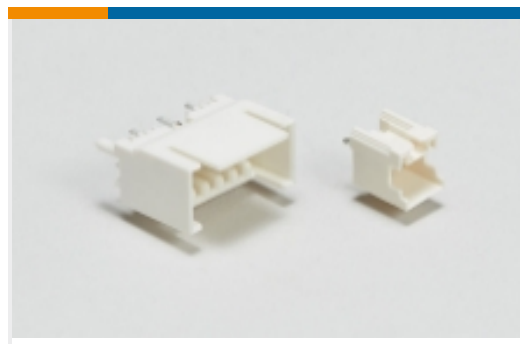

Wire-to-Board Headers & Receptacles (1182)

Customers Also Bought



TE Part #1-5499910-0
AMP-LATCH UNIVERSAL HEADERS

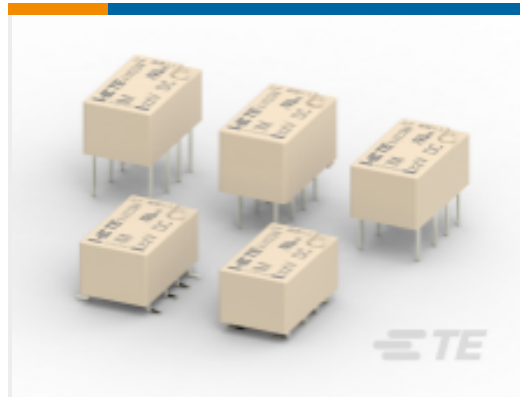

TE Part #2-1462037-7
Standard Signal Relay 2 Form C,2 CO Cont



TE Part #1734300-1
SHIELD FINGER 3025-Z1-T



TE Part #1776293-3
TSB23003DS=EUROPA TERM BLK, 8MM



TE Part #1-643075-4
Nylon PCB Connector Covers: 2.54 mm, MTA 100

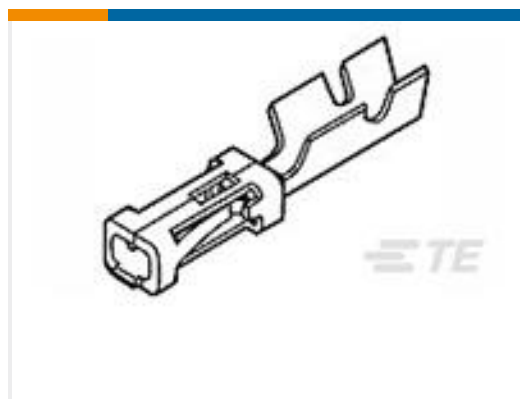

TE Part #103455-1
MOD V RECP PLTD 30 AU



TE Part #DT06-12SB-C015
DEUTSCH DT Series Housings & Connectors

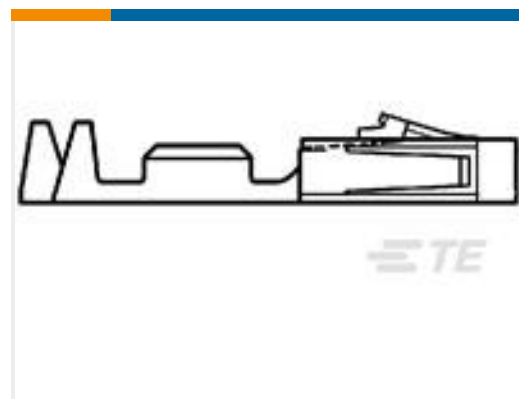

TE Part #104481-7
SHORT POINT RECP CONT LP



TE Part #1633962-7
CRIMPER, INSULATION F PREMIUM

Documents

Product Drawings

13P MTA100 MOLDED COVER

English

CAD Files

3D PDF

3D

3D PDF

English



Customer View Model

[ENG_CVM_1-643075-3_G.3d_igs.zip](#)

English

Customer View Model

[ENG_CVM_1-643075-3_G.3d_stp.zip](#)

English

Customer View Model

[ENG_CVM_1-643075-3_G.2d_dxf.zip](#)

English

Customer View Model

[ENG_CVM_CVM_1-643075-3_N.2d_dxf.zip](#)

English

Customer View Model

[ENG_CVM_CVM_1-643075-3_N.3d_igs.zip](#)

English

Customer View Model

[ENG_CVM_CVM_1-643075-3_N.3d_stp.zip](#)

English

By downloading the CAD file I accept and agree to the [Terms and Conditions](#) of use.

Datasheets & Catalog Pages

[MTA, CST-100 II, SL-156 and AMP Economy Power \(EP\) Connectors](#)

English

Product Environmental Compliance

[Product Compliance](#)

English

[Product Compliance](#)

English

Instruction Sheets

[Instruction Sheet \(U.S.\)](#)

English