

1-968317-3 ✓ ACTIVE

AMP | MQS

TE Internal #: 1-968317-3

MQS, Automotive Connector Caps & Covers, Shield, Without,  
Black, PBT GF, 24 Position, 2.54mm [.1in] Centerline

[View on TE.com >](#)



Connectors > Automotive Connectors > Connector Accessories > Connector Caps & Covers

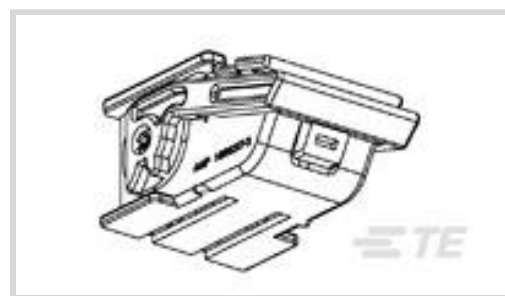

Protection & Strain Relief Accessory Type: **Shield**

Strain Relief: **Without**

Primary Product Color: **Black**

Primary Product Material: **PBT GF**

Number of Positions: **24**

## Features

### Product Type Features

Protection & Strain Relief Accessory Type	Shield
Sealable	No

### Configuration Features

Compatible With Connector Code	A
Number of Positions	24

### Body Features

Primary Product Color	Black
Primary Product Material	PBT GF

### Mechanical Attachment

Strain Relief	Without
---------------	---------

### Housing Features

Centerline (Pitch)	2.54 mm[.1 in]
--------------------	----------------

### Dimensions

Cable Bundle Diameter	15.2 mm[.598 in]
-----------------------	------------------

### Usage Conditions

Operating Temperature (Max)	70 °C, 75 °C, 80 °C, 85 °C, 90 °C, 100 °C, 105 °C, 110 °C, 120 °C[158 °F][167 °F][176 °F][185 °F][194 °F][212 °F][221 °F][230 °F][248 °F]
-----------------------------	---



Operating Temperature Range -40 – 120 °C[-40 – 248 °F]

### Industry Standards

UL Flammability Rating UL 94HB

### Packaging Features

Packaging Quantity 2000

### Other

Serviceable Yes

## Product Compliance

[For compliance documentation, visit the product page on TE.com>](#)

EU RoHS Directive 2011/65/EU Compliant

EU ELV Directive 2000/53/EC Compliant

China RoHS 2 Directive MIIT Order No 32, 2016 No Restricted Materials Above Threshold

EU REACH Regulation (EC) No. 1907/2006  
Current ECHA Candidate List: JAN 2021 (211)  
Candidate List Declared Against: JAN 2021 (211)  
Does not contain REACH SVHC

Halogen Content Low Halogen - Br, Cl, F, I < 900 ppm per homogenous material. Also BFR/CFR/PVC Free

Solder Process Capability Not applicable for solder process capability

#### Product Compliance Disclaimer

This information is provided based on reasonable inquiry of our suppliers and represents our current actual knowledge based on the information they provided. This information is subject to change. The part numbers that TE has identified as EU RoHS compliant have a maximum concentration of 0.1% by weight in homogenous materials for lead, hexavalent chromium, mercury, PBB, PBDE, DBP, BBP, DEHP, DIBP, and 0.01% for cadmium, or qualify for an exemption to these limits as defined in the Annexes of Directive 2011/65/EU (RoHS2). Finished electrical and electronic equipment products will be CE marked as required by Directive 2011/65/EU. Components may not be CE marked. Additionally, the part numbers that TE has identified as EU ELV compliant have a maximum concentration of 0.1% by weight in homogenous materials for lead, hexavalent chromium, and mercury, and 0.01% for cadmium, or qualify for an exemption to these limits as defined in the Annexes of Directive 2000/53/EC (ELV). Regarding the REACH Regulation, the information TE provides on SVHC in articles for this part number is based on the latest European Chemicals Agency (ECHA) 'Guidance on requirements for substances in articles' posted at this URL: <https://echa.europa.eu/guidance-documents/guidance-on-reach>

## Compatible Parts



### Also in the Series | MQS

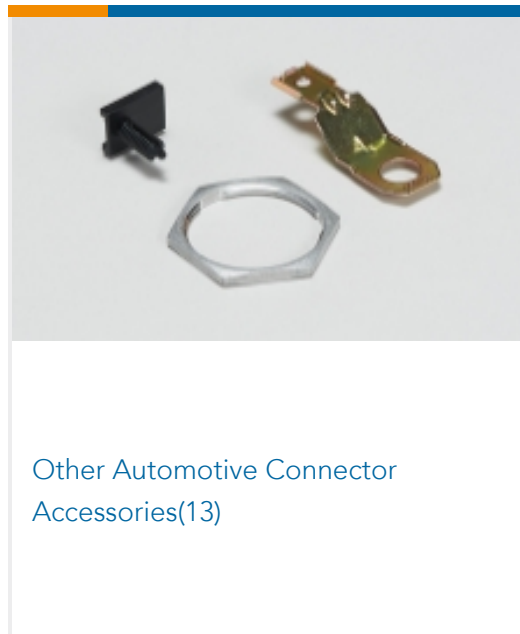
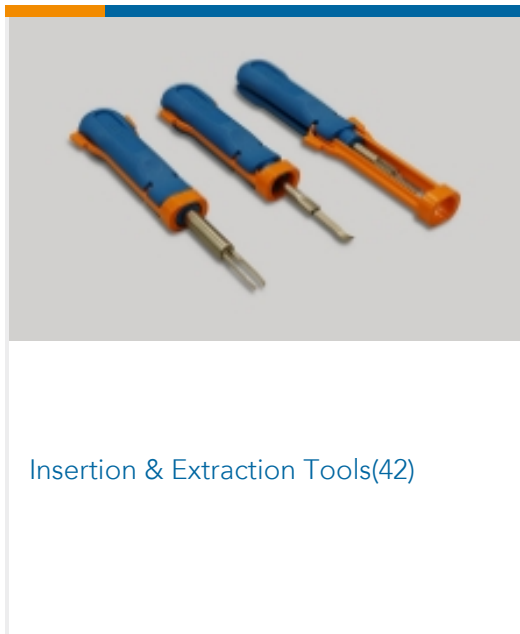
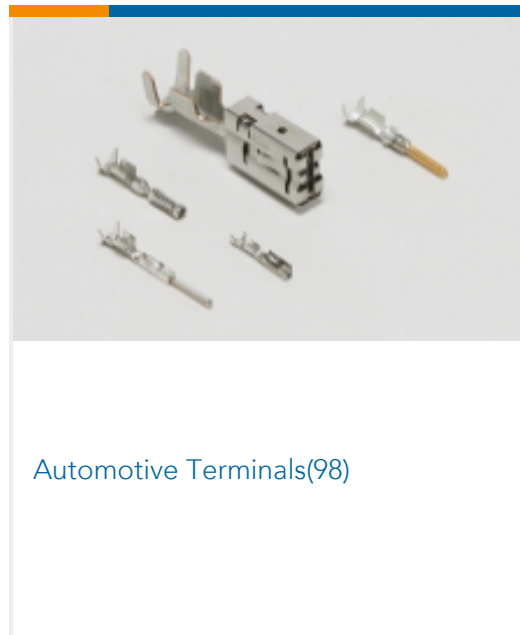
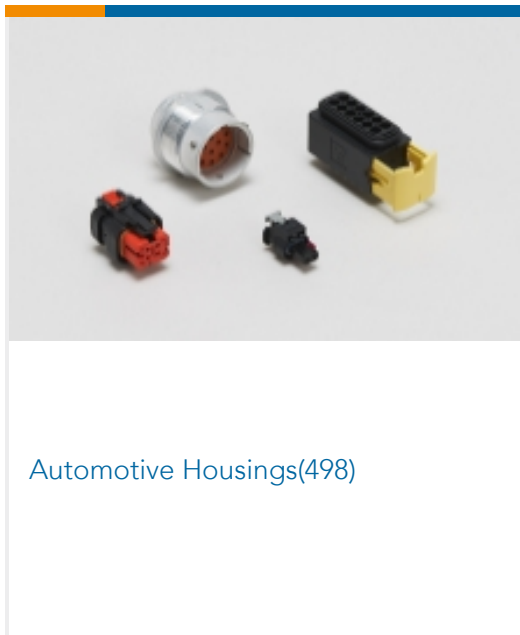
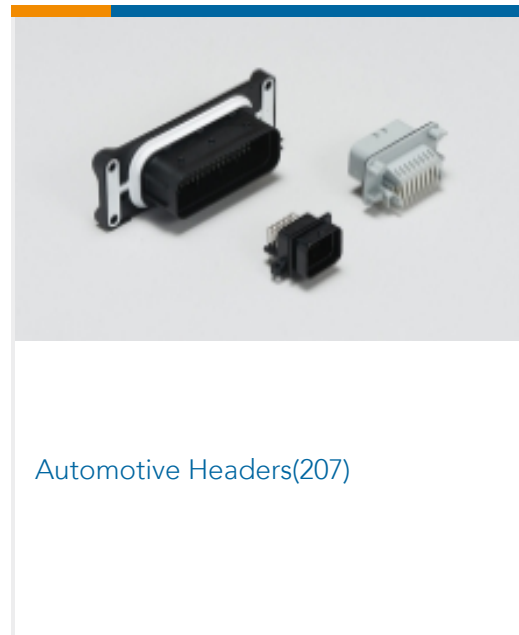
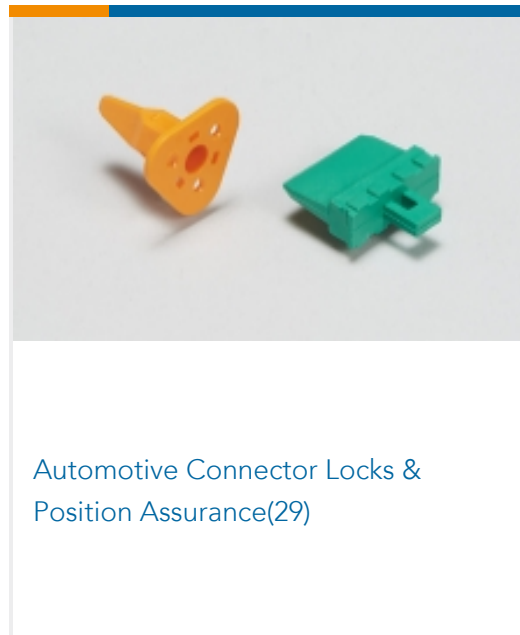
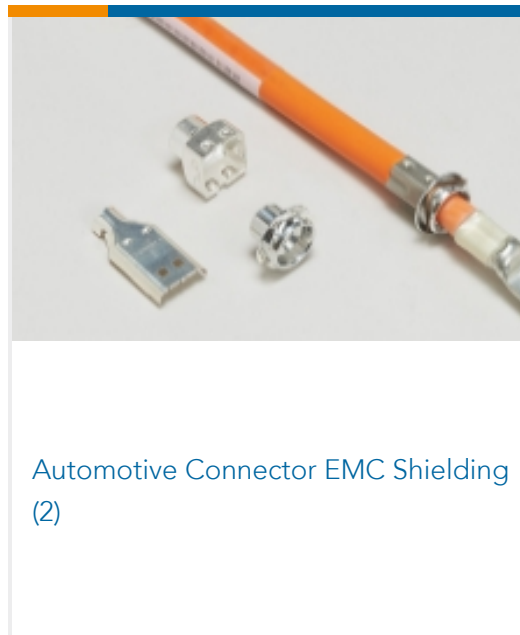
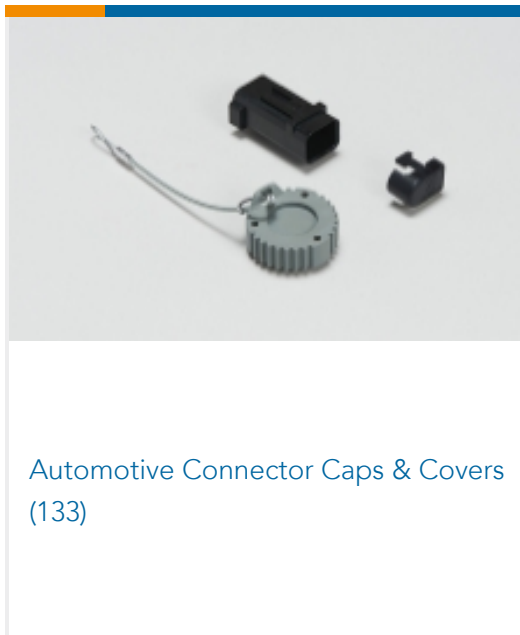

### Customers Also Bought



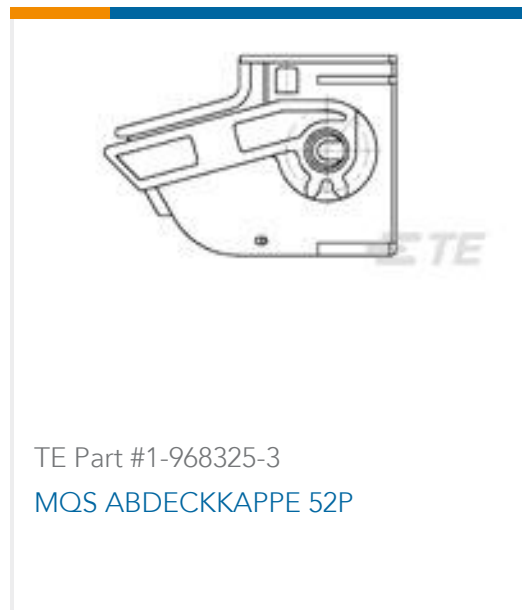

## Documents

### Product Drawings

#### MQS ABDECKKAPPE 24P

English

### CAD Files

#### 3D PDF

3D

#### Customer View Model

[ENG\\_CVM\\_CVM\\_1-968317-3\\_C.2d\\_dxf.zip](#)

English

#### Customer View Model

[ENG\\_CVM\\_CVM\\_1-968317-3\\_C.3d\\_igs.zip](#)

English

#### Customer View Model

[ENG\\_CVM\\_CVM\\_1-968317-3\\_C.3d\\_stp.zip](#)

English

By downloading the CAD file I accept and agree to the [Terms and Conditions](#) of use.

### Product Specifications

#### STEUERGERATESTECKER 134-POL. MICRO QUADLOCK SYSTEM JUNIOR POWER TIMER

English

#### Product Specification

English