

1376390-1 ✓ ACTIVE



## Power Key 5.0

TE Internal #: 1376390-1

Power Key 5.0, Rectangular Power Connectors, Housing, Plug, Wire-to-Board, 4 Position, 5mm [.197in] Centerline, Wire & Cable, UL 94V-0

[View on TE.com >](#)

Connectors > Power Connectors > Rectangular Power > Rectangular Power Connectors > STD Temp Power Key Plug

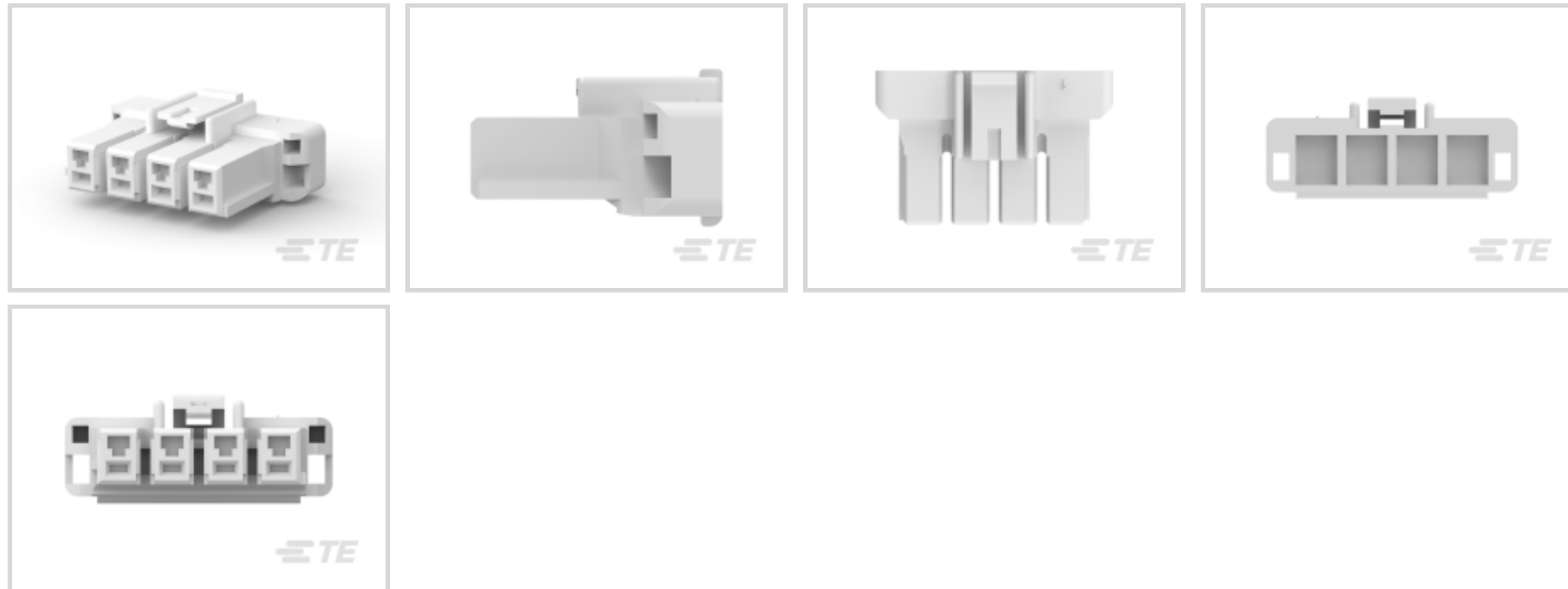

Rectangular Power Connector Type: **Housing**

Connector & Housing Type: **Plug**

Connector System: **Wire-to-Board**

Number of Positions: **4**

Centerline (Pitch): **5 mm [ .197 in ]**

[All STD Temp Power Key Plug \(34\)](#)

## Features

### Product Type Features

Rectangular Power Connector Type	Housing
Connector & Housing Type	Plug
Connector System	Wire-to-Board
Sealable	No
Connector & Contact Terminates To	Wire & Cable

### Configuration Features

Number of Positions	4
Number of Power Positions	0
Number of Signal Positions	0
Number of Rows	1

### Electrical Characteristics

Operating Voltage	300 VAC
-------------------	---------



### Contact Features

Contact Base Material	Copper Alloy
Contact Current Rating (Max)	10 A
Contact Retention Within Housing	Without
Contact Type	Socket

### Termination Features

Termination Method to Wire & Cable	Crimp
------------------------------------	-------

### Mechanical Attachment

Strain Relief	Without
Mating Alignment Type	Keyed
Mating Alignment	With
Panel Mount Feature	Without
PCB Mount Retention	Without
Connector Mounting Type	Cable Mount (Free-Hanging)
Mating Retention	With
Mating Retention Type	Latch

### Housing Features

Centerline (Pitch)	5 mm [.197 in]
Housing Color	Natural
Housing Material	Nylon 6/6 GF

### Dimensions

Wire Size	434.18 – 2466.91 CMA
Width	16.2 mm [.638 in]
Accepts Wire Insulation Diameter Range	1.7 – 3.1 mm [.067 – .122 in]
Height	9.6 mm [.378 in]
Length	25 mm [.984 in]

### Usage Conditions

Operating Temperature Range	-40 – 105 °C [-40 – 221 °F]
-----------------------------	-----------------------------

### Operation/Application

Circuit Application	Power & Signal
---------------------	----------------

### Industry Standards

UL Flammability Rating	UL 94V-0
------------------------	----------



Glow Wire Rating	Standard Part - Not Glow Wire
------------------	-------------------------------

Agency/Standard Number	E28476
------------------------	--------

Agency/Standard	CSA, UL
-----------------	---------

UL Rating	Recognized
-----------	------------

CSA File Number	LR 7189
-----------------	---------

### Packaging Features

Packaging Method	Bag
------------------	-----

Packaging Quantity	500
--------------------	-----

### Other

For Use With	Receptacle Housing
--------------	--------------------

## Product Compliance

[For compliance documentation, visit the product page on TE.com>](#)

EU RoHS Directive 2011/65/EU	Compliant
------------------------------	-----------

EU ELV Directive 2000/53/EC	Compliant
-----------------------------	-----------

China RoHS 2 Directive MIIT Order No 32, 2016	No Restricted Materials Above Threshold
---	---

EU REACH Regulation (EC) No. 1907/2006	Current ECHA Candidate List: JAN 2021 (211) Candidate List Declared Against: JAN 2021 (211) Does not contain REACH SVHC
--	---

Halogen Content	Not Low Halogen - contains Br or Cl > 900 ppm.
-----------------	--

Solder Process Capability	Not applicable for solder process capability
---------------------------	--

#### Product Compliance Disclaimer

This information is provided based on reasonable inquiry of our suppliers and represents our current actual knowledge based on the information they provided. This information is subject to change. The part numbers that TE has identified as EU RoHS compliant have a maximum concentration of 0.1% by weight in homogenous materials for lead, hexavalent chromium, mercury, PBB, PBDE, DBP, BBP, DEHP, DIBP, and 0.01% for cadmium, or qualify for an exemption to these limits as defined in the Annexes of Directive 2011/65/EU (RoHS2). Finished electrical and electronic equipment products will be CE marked as required by Directive 2011/65/EU. Components may not be CE marked. Additionally, the part numbers that TE has identified as EU ELV compliant have a maximum concentration of 0.1% by weight in homogenous materials for lead, hexavalent chromium, and mercury, and 0.01% for cadmium, or qualify for an exemption to these limits as defined in the Annexes of Directive 2000/53/EC (ELV). Regarding the REACH Regulation, the information TE provides on SVHC in articles for this part number is based on the latest European Chemicals Agency (ECHA) 'Guidance on requirements for substances in articles' posted at this URL: <https://echa.europa.eu/guidance-documents/guidance-on-reach>

## Compatible Parts

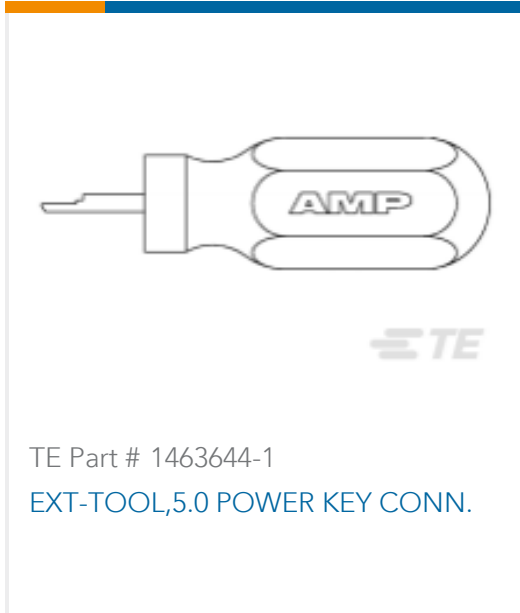
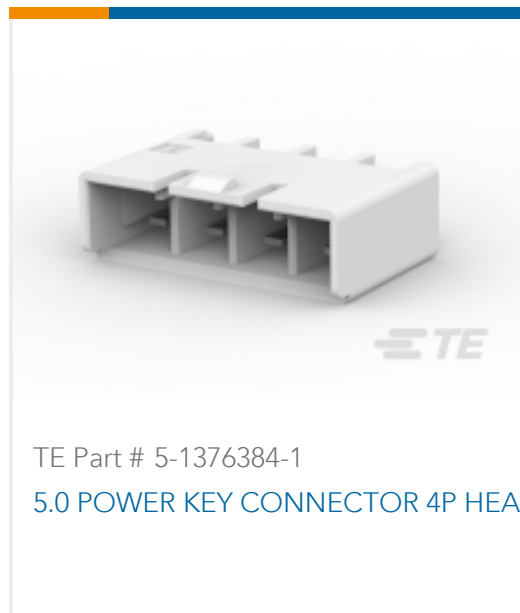
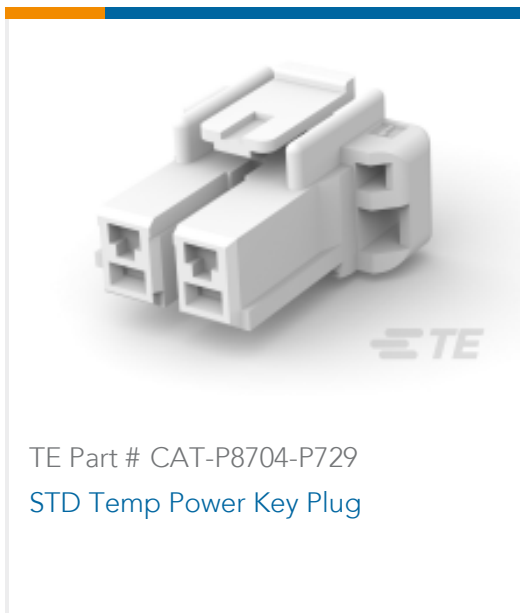

Also in the Series | **Power Key 5.0**

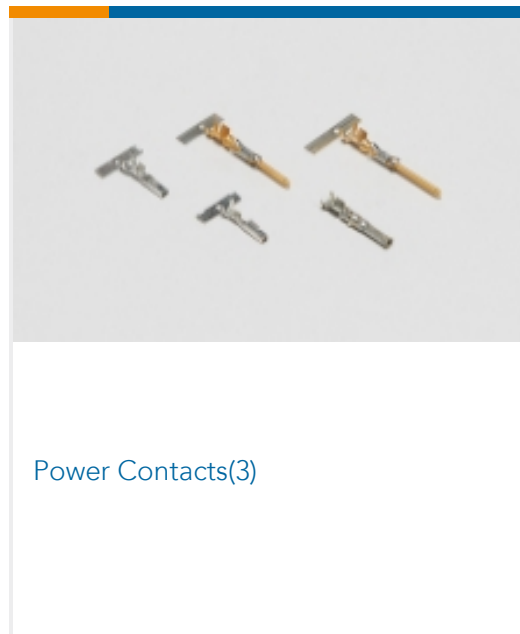
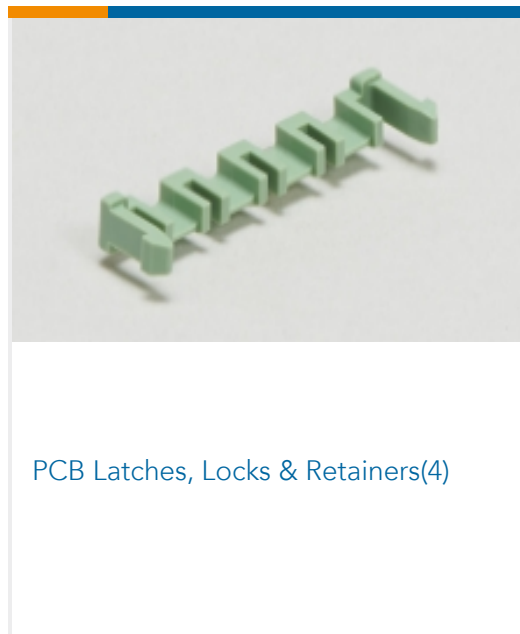
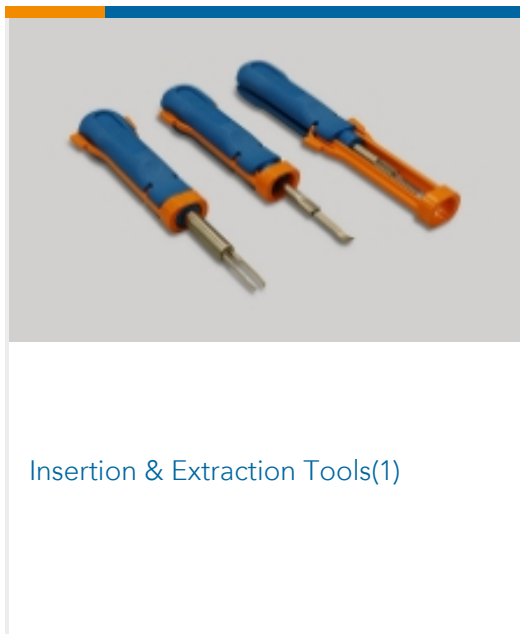

Customers Also Bought

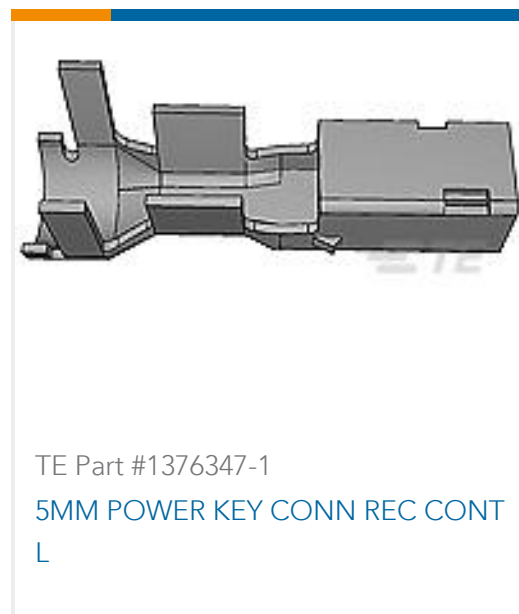
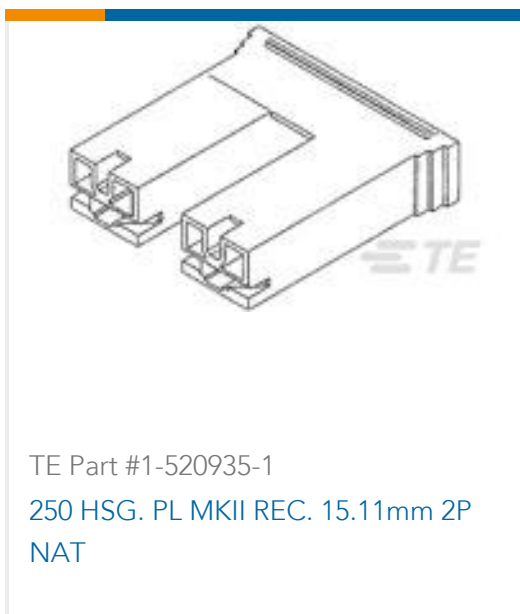
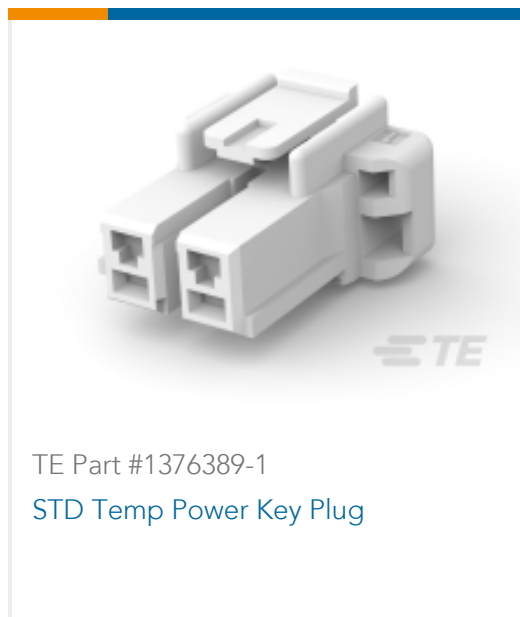



## Documents

### Product Drawings

[5MM POWER KEY 4P PLUG HSG NUT](#)

English

[5MM POWER KEY 4P PLUG HSG NUT](#)

English

### CAD Files

[3D PDF](#)

3D

[3D PDF](#)

English

**Customer View Model**

[ENG\\_CVM\\_1376390-1\\_B.2d\\_dxf.zip](#)

English

**Customer View Model**

[ENG\\_CVM\\_1376390-1\\_B.3d\\_igs.zip](#)

English

**Customer View Model**

[ENG\\_CVM\\_1376390-1\\_B.3d\\_stp.zip](#)

English

**Customer View Model**

[ENG\\_CVM\\_CVM\\_1376390-1\\_F.2d\\_dxf.zip](#)

English

**Customer View Model**

[ENG\\_CVM\\_CVM\\_1376390-1\\_F.3d\\_igs.zip](#)

English

**Customer View Model**

[ENG\\_CVM\\_CVM\\_1376390-1\\_F.3d\\_stp.zip](#)

English

By downloading the CAD file I accept and agree to the [Terms and Conditions](#) of use.

### Datasheets & Catalog Pages

[SOFT\\_SHELL\\_PIN\\_SOCKET\\_CONNECTORS\\_STANDARD\\_DENSITY](#)

English

[1-1773881-9 Power Key Connector Quick Reference Guide](#)



English

---

**Product Specifications**

**5.0 POWER KEY CONNECTOR**

Japanese

**Application Specification**

Japanese

---

**Product Environmental Compliance**

**MD\_1376390-1\_06122018722\_dmtec**

English

**MD\_1376390-1\_06122018722\_dmtec**

English

---

**Instruction Sheets**

**The extraction tool for 5MM Power Key Contact**

English

**Instruction Sheet (non U.S.)**

English

---

**Agency Approvals**

**VDE Certificate**

English