

42475-4 ✓ ACTIVE

FASTON | FASTON 250

TE Internal #: 42475-4

FASTON 250, Quick Disconnects, Tab, 22 – 18AWG Wire Size, .32 – .82mm<sup>2</sup> Wire Size, Quick Disconnect Mating Tab Width 6.35 mm [.25 in]

[View on TE.com >](#)



Terminals & Splices > Quick Disconnects

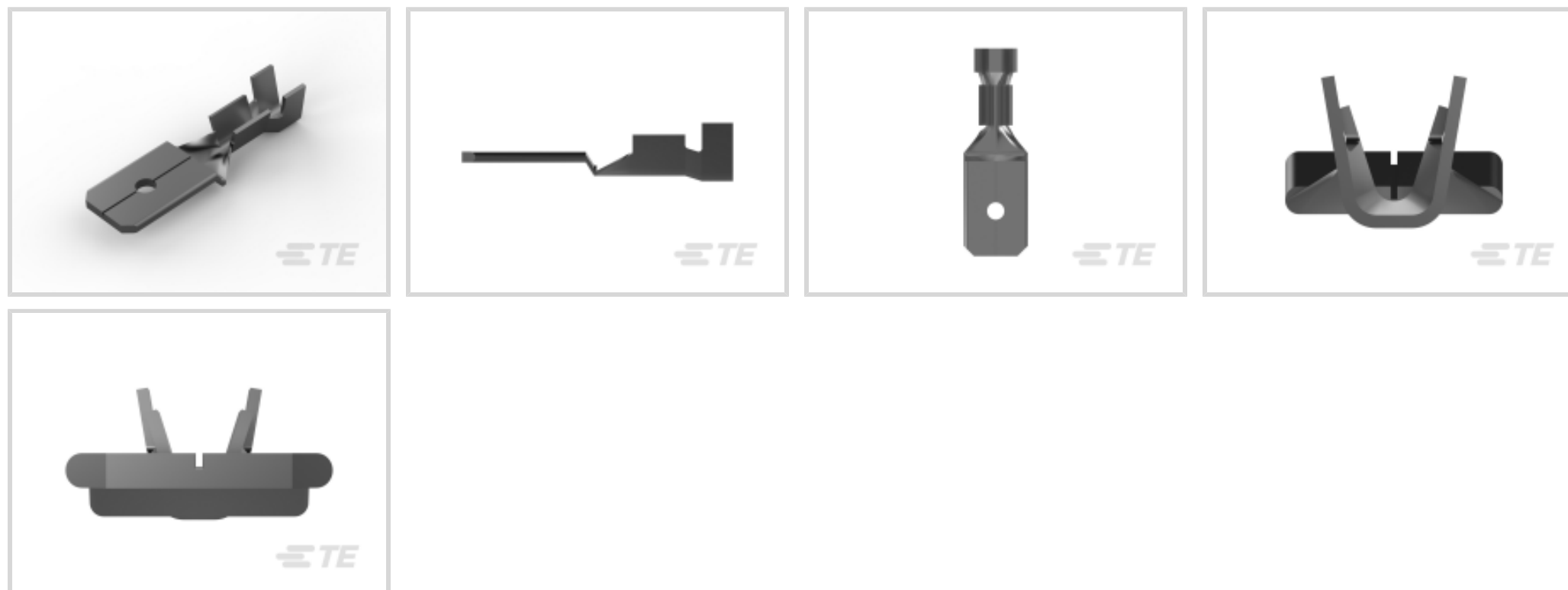

Terminal & Splice Type: **Tab**

Wire Size: **.32 – .82 mm<sup>2</sup>**

Quick Disconnect Mating Tab Width: **6.35 mm [.25 in]**

Quick Disconnect Mating Tab Thickness: **.81 mm [.032 in]**

## Features

### Product Type Features

Wire Stop	No
Wire/Cable Type	Regular Wire
Terminates To	Wire & Cable
Quick Disconnect Insertion Force	Normal
Sealable	No
Insulated	No

### Configuration Features

Connection Capacity	Single
---------------------	--------

### Body Features

Fully Insulated	No
Quick Disconnect Plating Material	Tin

### Contact Features

Terminal Type	Tab
Terminal & Splice Type	Tab



Quick Disconnect Terminal Orientation	Straight
Contact Base Material	Brass
Crimp Type	F-Crimp
Barrel Type	Open

### Mechanical Attachment

Mating Retention Type	Dimple
Wire Insulation Support	With

### Dimensions

Accepts Wire Insulation Diameter Range	2.03 – 3.05 mm [.08 – .12 in]
Overall Length	20.7 mm [.815 in]
Receptacle Terminal Stock Thickness	.4 mm [.015 in]
Wire Size	.32 – .82 mm <sup>2</sup>
Quick Disconnect Mating Tab Width	6.35 mm [.25 in]
Quick Disconnect Mating Tab Thickness	.81 mm [.032 in]

### Usage Conditions

Insulation Requirement	Uninsulated
Operating Temperature Range	-40 – 110 °C [-40 – 230 °F]

### Industry Standards

UL Rating	Listed
CSA Certified	Yes

### Packaging Features

Packaging Quantity	3500
Quick Disconnect Packaging Method	Strip/Reel

### Product Compliance

[For compliance documentation, visit the product page on TE.com>](#)

EU RoHS Directive 2011/65/EU	Compliant
EU ELV Directive 2000/53/EC	Compliant
China RoHS 2 Directive MIIT Order No 32, 2016	No Restricted Materials Above Threshold
EU REACH Regulation (EC) No. 1907/2006	Current ECHA Candidate List: JAN 2021 (211) Candidate List Declared Against: JAN 2021 (211) Does not contain REACH SVHC

Halogen Content

Low Halogen - Br, Cl, F, I < 900 ppm per homogenous material. Also BFR/CFR/PVC Free

Solder Process Capability

Not applicable for solder process capability

Product Compliance Disclaimer

This information is provided based on reasonable inquiry of our suppliers and represents our current actual knowledge based on the information they provided. This information is subject to change. The part numbers that TE has identified as EU RoHS compliant have a maximum concentration of 0.1% by weight in homogenous materials for lead, hexavalent chromium, mercury, PBB, PBDE, DBP, BBP, DEHP, DIBP, and 0.01% for cadmium, or qualify for an exemption to these limits as defined in the Annexes of Directive 2011/65/EU (RoHS2). Finished electrical and electronic equipment products will be CE marked as required by Directive 2011/65/EU. Components may not be CE marked. Additionally, the part numbers that TE has identified as EU ELV compliant have a maximum concentration of 0.1% by weight in homogenous materials for lead, hexavalent chromium, and mercury, and 0.01% for cadmium, or qualify for an exemption to these limits as defined in the Annexes of Directive 2000/53/EC (ELV). Regarding the REACH Regulation, the information TE provides on SVHC in articles for this part number is based on the latest European Chemicals Agency (ECHA) 'Guidance on requirements for substances in articles' posted at this URL: <https://echa.europa.eu/guidance-documents/guidance-on-reach>

## Compatible Parts



TE Part # 60794-2  
FASTIN FASTON .250 TAB 16-14 AWG TPBR



TE Part # 63165-2  
FASTON 110 AMPLIVAR TAB 23-19 MAG TPBR



TE Part # 2305570-1  
TERMINAL CUTTER, SIDE FEED



TE Part # 63919-1  
FASTON .187 TAB 18-14 AWG TPBR



TE Part # 1494210-2  
110 FASTON,TAB,22-17 AWG, JIS C260



TE Part # 1742753-1  
FASTON 2MM TAB 18-22AWG TPBR



TE Part # 61367-3  
FASTON .250 TAB 18-14 AWG TPBR



TE Part # 1494210-1  
110 FASTON,TAB,22-17 AWG, JIS C260



REPRESENTATION ONLY  
TE Part # 575046-1  
DAHT 250 FASTON 22-14 ASSY



TE Part # 180353-2  
250 FASTON,TAB,12-10 AWG,TPBR



TE Part # 180353-1  
250 FASTON,TAB,12-10 AWG,BR



TE Part # 180353-3  
250 FASTON,TAB,12-10 AWG,TPBR



Also in the Series | **FASTON 250**

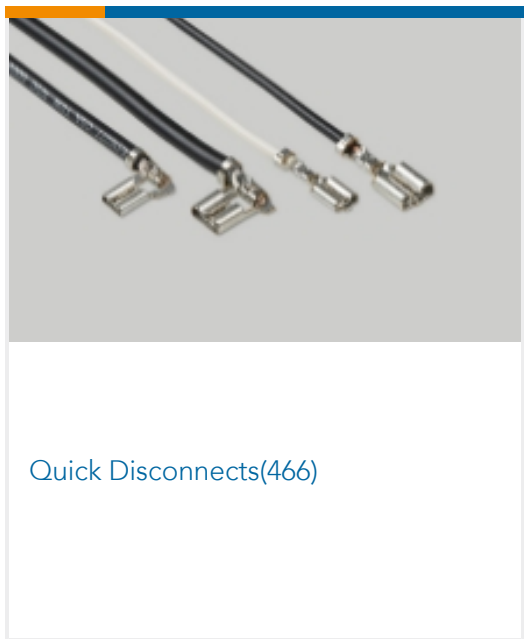
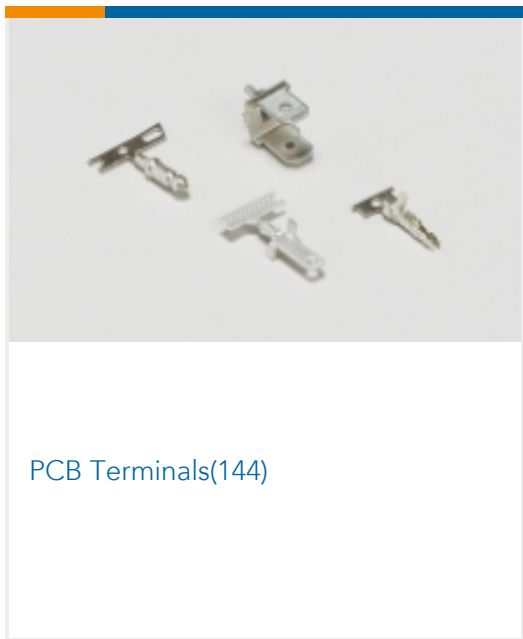
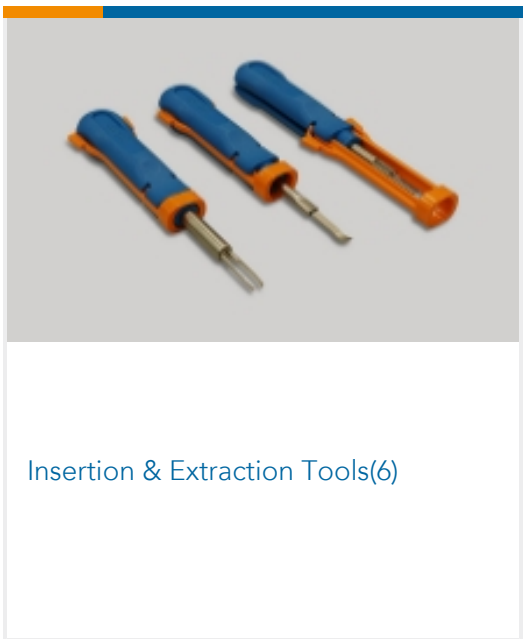
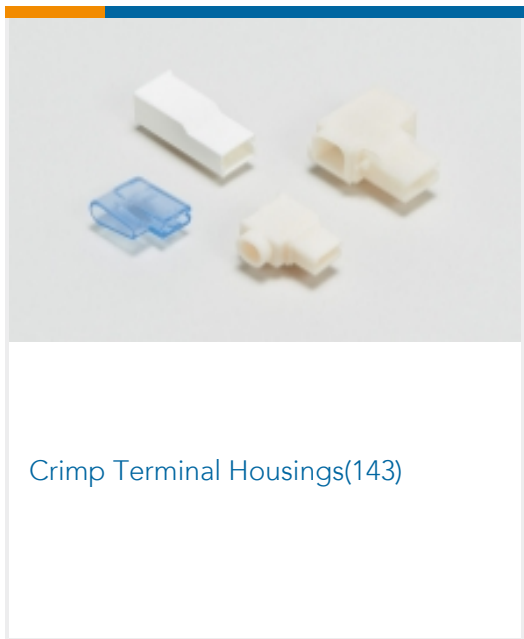
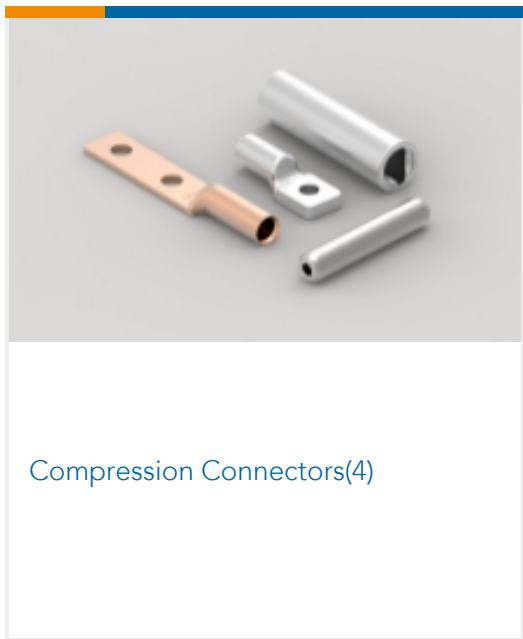

Customers Also Bought

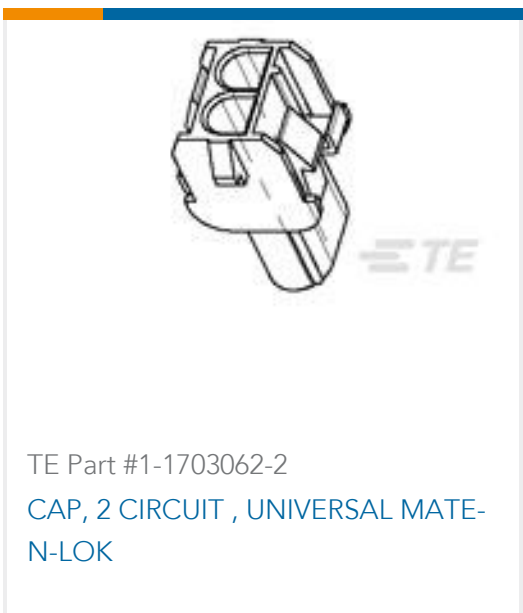



## Documents

### CAD Files

#### 3D PDF

3D

#### Customer View Model

[ENG\\_CVM\\_CVM\\_42475-4\\_AG.2d\\_dxf.zip](#)

English

#### Customer View Model

[ENG\\_CVM\\_CVM\\_42475-4\\_AG.3d\\_igs.zip](#)

English

#### Customer View Model

[ENG\\_CVM\\_CVM\\_42475-4\\_AG.3d\\_stp.zip](#)

English

By downloading the CAD file I accept and agree to the [Terms and Conditions](#) of use.

### Datasheets & Catalog Pages

#### FASTON Tabs

English

### Product Specifications

#### Application Specification

English

### Product Environmental Compliance

[MD\\_42475-4\\_060520181211\\_dmtec](#)

English

[MD\\_42475-4\\_060520181211\\_dmtec](#)

English



[Agency Approvals](#)

[UL Report](#)

English