

321017 ✓ ACTIVE

PIDG

TE Internal #: 321017

PIDG, Ring Terminals & Spade Terminals, Ring Tongue, 26 – 22AWG Wire Size, .12 – .4mm² Wire Size, 202 – 810CMA Wire Size, #4 / M2.5

[View on TE.com >](#)



Terminals & Splices > Ring Terminals & Spade Terminals



Terminal & Splice Type: **Ring Tongue**

Wire Size: **202 – 810 CMA**

Ring & Spade Stud Size: **#4, M2.5**

Features

Product Type Features

Shape Description	RING-041
Ring & Spade Stud Size	#4, M2.5
Ring & Spade Barrel Type	Closed Barrel
Sealable	No
Insulated	Yes
Ring & Spade Wire/Cable Type	Regular Wire
Support Style	Insulation Support

Configuration Features

Number of Holes	1
Terminal Angle	Straight

Electrical Characteristics

Voltage (Max)	300 V
---------------	-------

Body Features

Weight per Piece	.232 g
Ring & Spade Plating Material	Copper, Tin

Contact Features

Military Part Class	Class II
Terminal & Splice Type	Ring Tongue
Ring & Spade Terminal Orientation	Straight

Mechanical Attachment

Wire Insulation Support	With
-------------------------	------

Dimensions

Wire Size	202 – 810 CMA
Stud Diameter	3.02 mm[.119 in]
Tongue Thickness	.79 mm[.031 in]
Ring & Spade Overall Length	16.41 mm[.646 in]
Ring & Spade Wire Insulation Diameter (Max)	2.03 mm[.08 in]
Ring & Spade Wire Insulation Diameter	1.27 – 2.03 mm[.05 – .08 in]

Usage Conditions

Insulation Requirement	Partially Insulated
Operating Temperature Range	105 °C[221 °F]

Operation/Application

Heavy Duty	No
------------	----

Industry Standards

Government Qualified	No
----------------------	----

Packaging Features

Packaging Quantity	1000
Ring & Spade Packaging Method	Box

Product Compliance

[For compliance documentation, visit the product page on TE.com>](#)

EU RoHS Directive 2011/65/EU	Compliant
EU ELV Directive 2000/53/EC	Compliant
China RoHS 2 Directive MIIT Order No 32, 2016	No Restricted Materials Above Threshold
EU REACH Regulation (EC) No. 1907/2006	Current ECHA Candidate List: JAN 2021 (211) Candidate List Declared Against: JAN 2021 (211) Does not contain REACH SVHC
Halogen Content	Low Halogen - Br, Cl, F, I < 900 ppm per homogenous material. Also BFR/CFR/PVC Free
Solder Process Capability	Not applicable for solder process capability

Product Compliance Disclaimer

This information is provided based on reasonable inquiry of our suppliers and represents our current actual knowledge based on the information they provided. This information is subject to change. The part numbers that TE has identified as EU RoHS compliant have a maximum concentration of 0.1% by weight in homogenous materials for lead, hexavalent chromium, mercury, PBB, PBDE, DBP, BBP, DEHP, DIBP, and 0.01% for cadmium, or qualify for an exemption to these limits as defined in the Annexes of Directive 2011/65/EU (RoHS2). Finished electrical and electronic equipment products will be CE marked as required by Directive 2011/65/EU. Components may not be CE marked. Additionally, the part numbers that TE has identified as EU ELV compliant have a maximum concentration of 0.1% by weight in homogenous materials for lead, hexavalent chromium, and mercury, and 0.01% for cadmium, or qualify for an exemption to these limits as defined in the Annexes of Directive 2000/53/EC (ELV). Regarding the REACH Regulation, the information TE provides on SVHC in articles for this part number is based on the latest European Chemicals Agency (ECHA) 'Guidance on requirements for substances in articles' posted at this URL: <https://echa.europa.eu/guidance-documents/guidance-on-reach>

Compatible Parts



Also in the Series | PIDG

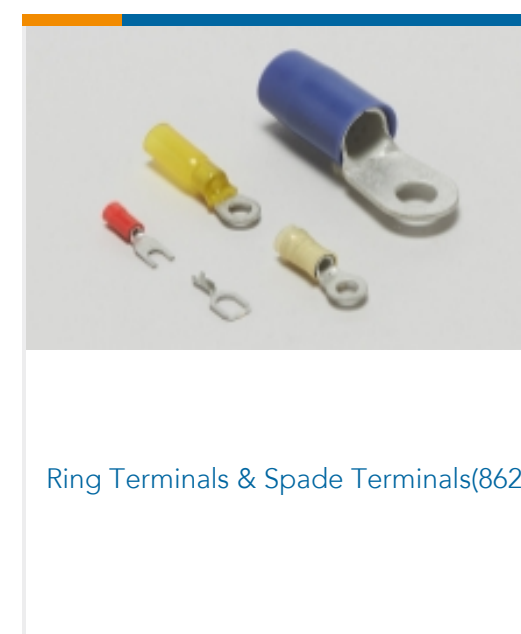
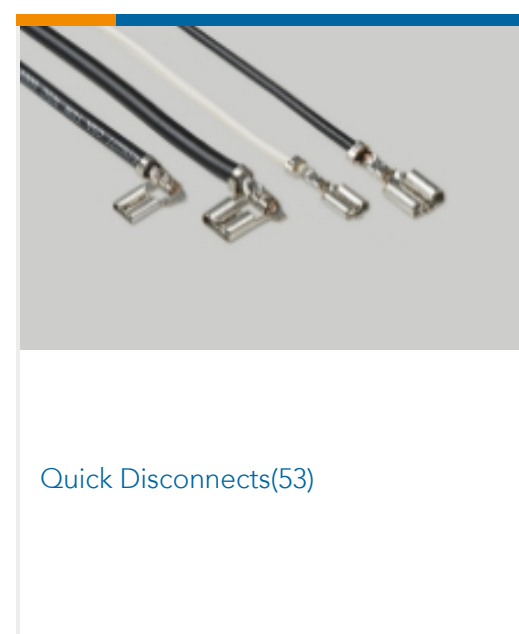
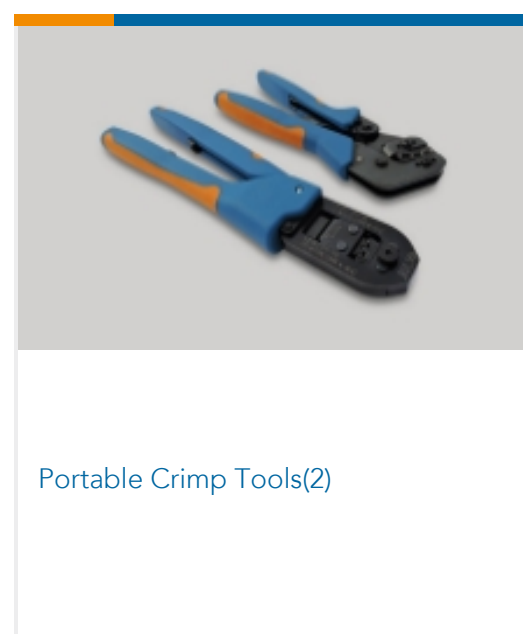
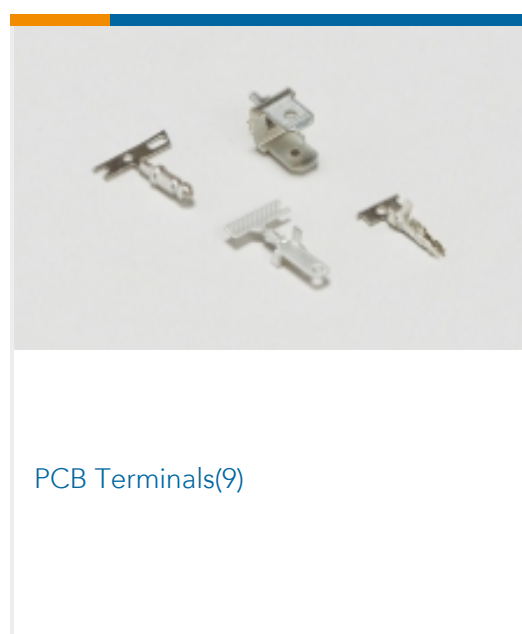
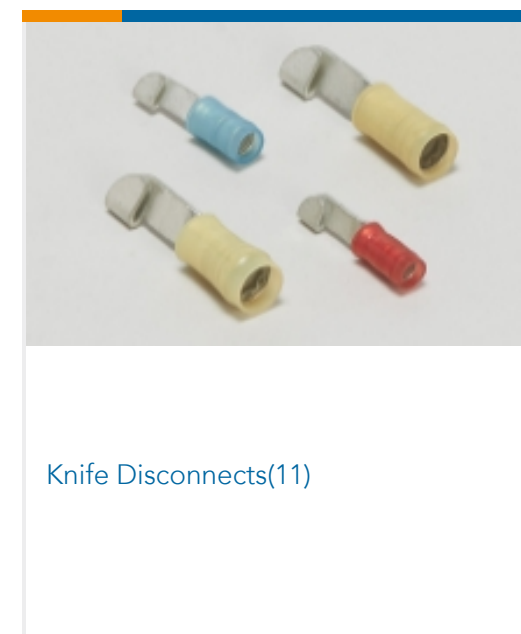
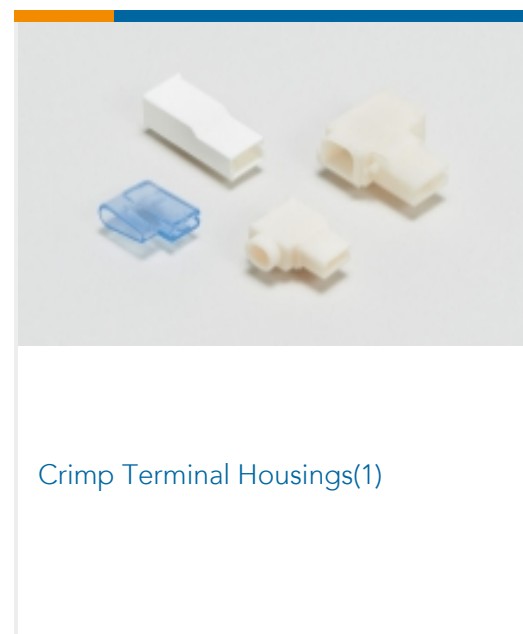
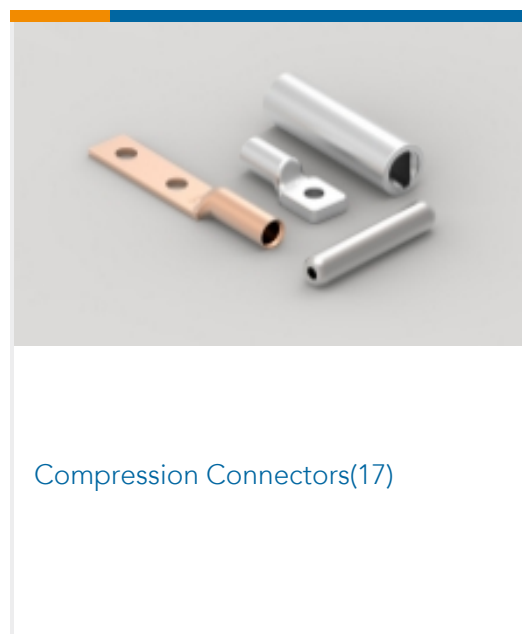



Special Purpose Terminals(1)



Splices(48)

Customers Also Bought



TE Part #2-323912-1
PIDG RING TONGUE TERMINALS



TE Part #160138
PIDG RING TONGUE



TE Part #130005
PIDG R 22-16 10 (5MM)



TE Part #171826-8
H-TYPE E.I.S.CONN. 8P ASSY

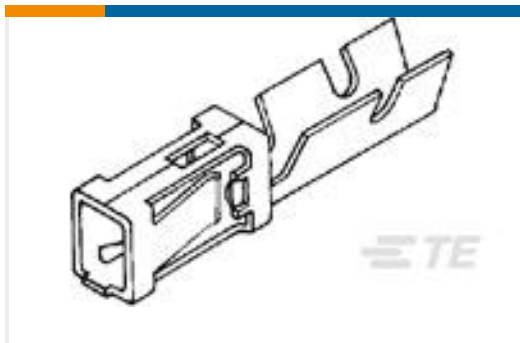

TE Part #182198-1
MOD 1 CONTACT



TE Part #170048-2
110 FASTON,REC.,24-20 AWG,TPBR

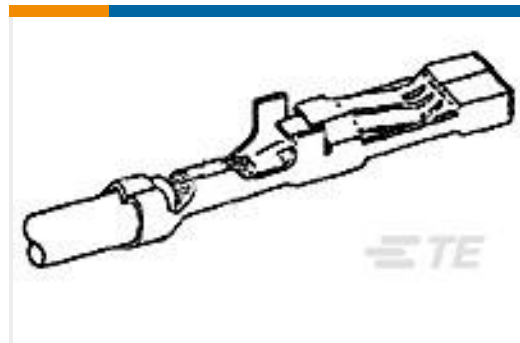

TE Part #170286-1
MIC REC CONTACT



TE Part #1052075-1
2037 5008 00,SMA RA CABLE PLUG



TE Part #ZPF000000000004591
901-20 B 61

Documents

Product Drawings

[TERMINAL,PIDG R 26-22 4](#)

English

CAD Files

[3D PDF](#)

English

Customer View Model

[ENG_CVM_321017_N.3d_igs.zip](#)



English

Customer View Model

[ENG_CVM_321017_N.3d_stp.zip](#)

English

Customer View Model

[ENG_CVM_321017_N.2d_dxf.zip](#)

English

By downloading the CAD file I accept and agree to the [Terms and Conditions](#) of use.

Product Specifications

[Application Specification](#)

English

Agency Approvals

[UL Report](#)

English

[UL Report](#)

English