

2-160983-1 ✓ ACTIVE

AMP-TY

TE Internal #: 2-160983-1

Cable Ties, Standard, Bag, 550Newton Tensile Strength, 123.65lbf Tensile Strength, Cable Tie Length 365 mm [14.4 in], Cable Tie Width .307 in [7.8 mm]

[View on TE.com >](#)



Wire & Cable > Wire & Cable Accessories > Cable Ties

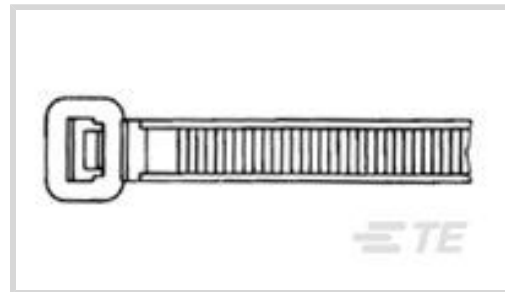

Cable Tie Style: **Standard**

Cable Tie Packaging Method: **Bag**

Tensile Strength: **123.65 lbf**

Cable Tie Length: **365 mm [14.4 in]**

Features

Product Type Features

Product Type	Cable Tie
Cable Tie Style	Standard
Tensile Strength	123.65 lbf

Body Features

Cable Tie Color	Natural
Cable Tie Material	Polyamide 6.6 GF

Dimensions

Bundle Range Diameter	100 mm[3.93 in]
Cable Tie Length	365 mm[14.4 in]
Cable Tie Width	7.8 mm[.307 in]
Cable Tie Thickness	1.8 mm[.07 in]

Packaging Features

Cable Tie Packaging Method	Bag
Cable Tie Packaging Quantity	100

Product Compliance

[For compliance documentation, visit the product page on TE.com>](#)

EU RoHS Directive 2011/65/EU	Compliant
EU ELV Directive 2000/53/EC	Not Yet Reviewed











China RoHS 2 Directive MIIT Order No 32, 2016	No Restricted Materials Above Threshold
EU REACH Regulation (EC) No. 1907/2006	Current ECHA Candidate List: JAN 2021 (211) Candidate List Declared Against: JAN 2020 (205) SVHC > Threshold: Not Yet Reviewed
Halogen Content	Not Low Halogen - contains Br or Cl > 900 ppm.
Solder Process Capability	Not applicable for solder process capability

Product Compliance Disclaimer

This information is provided based on reasonable inquiry of our suppliers and represents our current actual knowledge based on the information they provided. This information is subject to change. The part numbers that TE has identified as EU RoHS compliant have a maximum concentration of 0.1% by weight in homogenous materials for lead, hexavalent chromium, mercury, PBB, PBDE, DBP, BBP, DEHP, DIBP, and 0.01% for cadmium, or qualify for an exemption to these limits as defined in the Annexes of Directive 2011/65/EU (RoHS2). Finished electrical and electronic equipment products will be CE marked as required by Directive 2011/65/EU. Components may not be CE marked. Additionally, the part numbers that TE has identified as EU ELV compliant have a maximum concentration of 0.1% by weight in homogenous materials for lead, hexavalent chromium, and mercury, and 0.01% for cadmium, or qualify for an exemption to these limits as defined in the Annexes of Directive 2000/53/EC (ELV). Regarding the REACH Regulation, the information TE provides on SVHC in articles for this part number is based on the latest European Chemicals Agency (ECHA) 'Guidance on requirements for substances in articles' posted at this URL: <https://echa.europa.eu/guidance-documents/guidance-on-reach>

Compatible Parts

			
TE Part # CAT-T3437-K1 K-TYPE TIE-ON MARKERS	TE Part # EC6518-000 13611808	TE Part # EC6496-000 13611442	TE Part # EC6513-000 13611707
			
TE Part # EC6409-000 13611202	TE Part # EC6453-000 13611303	TE Part # EC6406-000 13611101	TE Part # EC6405-000 13611000



Customers Also Bought

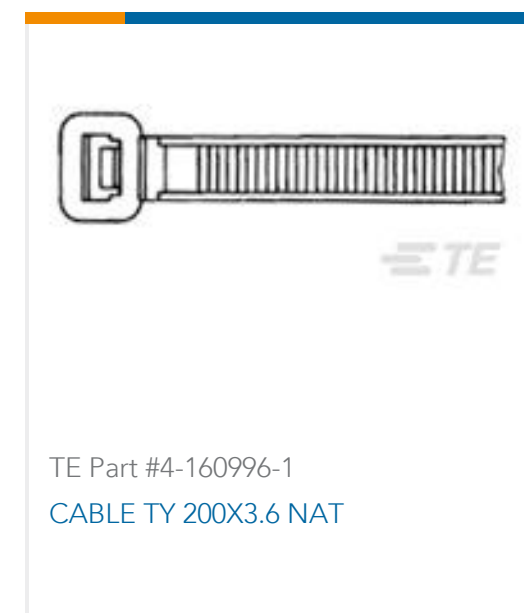
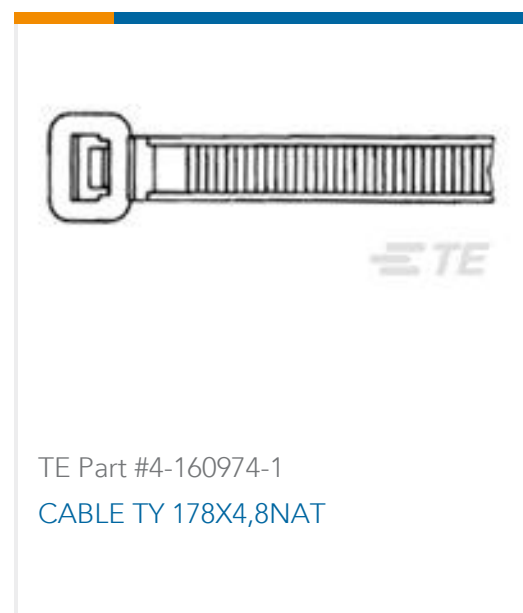
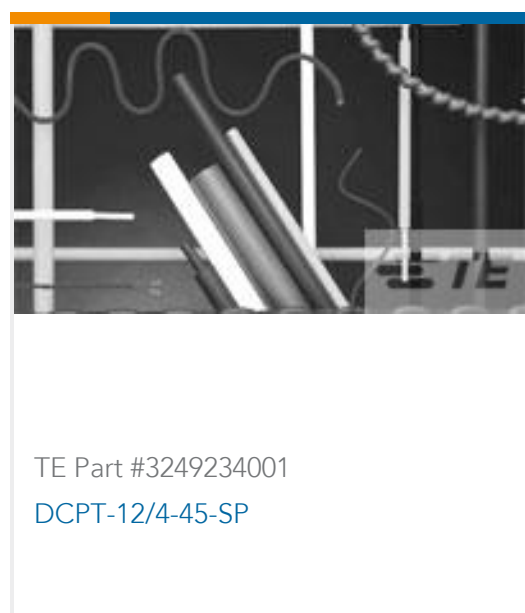
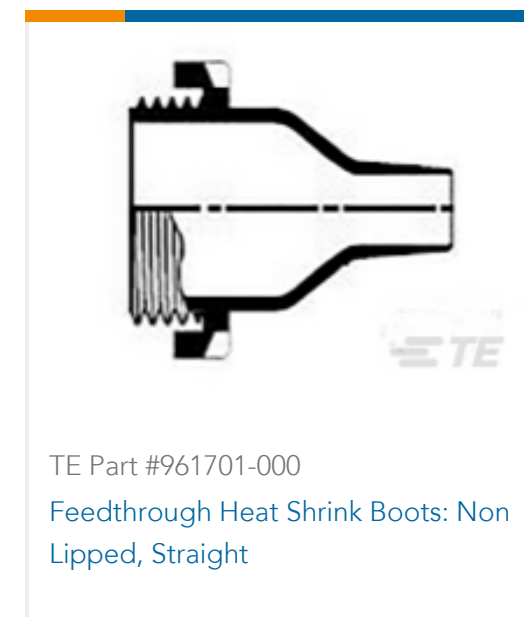
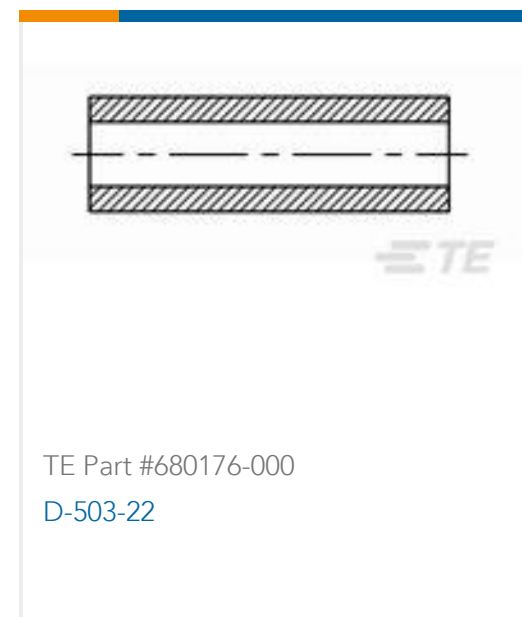



TE Part #654537-000
44AM1121-16-6/9-9CS2275

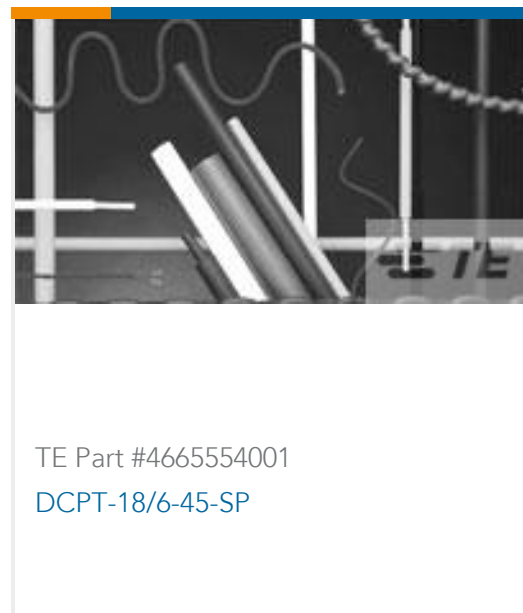

TE Part #4665554001
DCPT-18/6-45-SP

Documents

Product Drawings

[CABLE TY 365X7.8 NAT](#)

English

Datasheets & Catalog Pages

[Connectivity Solutions for Industrial Applications](#)

English

[CABLE TIES](#)

English