

4-160968-2 ✓ ACTIVE

AMP-TY

TE Internal #: 4-160968-2

Cable Ties, Standard, Bag, 82Newton Tensile Strength, 18.5lbf Tensile Strength, Cable Tie Length 134 mm [5.27 in], Cable Tie Width .102 in [2.6 mm]

[View on TE.com >](#)



Wire & Cable > Wire & Cable Accessories > Cable Ties

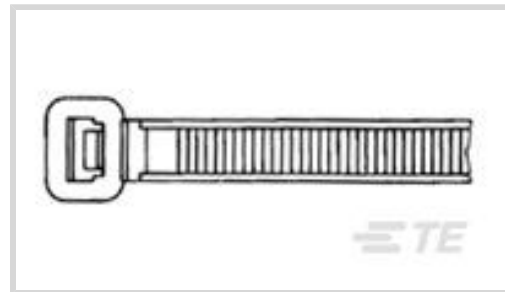

Cable Tie Style: **Standard**

Cable Tie Packaging Method: **Bag**

Tensile Strength: **18.5 lbf**

Cable Tie Length: **134 mm [5.27 in]**

Features

Product Type Features

Product Type	Cable Tie
Cable Tie Style	Standard
Tensile Strength	18.5 lbf

Body Features

Cable Tie Color	Black
Cable Tie Material	Polyamide 6.6 GF

Dimensions

Bundle Range Diameter	32 mm[1.26 in]
Cable Tie Length	134 mm[5.27 in]
Cable Tie Width	2.6 mm[.102 in]
Cable Tie Thickness	1 mm[.039 in]

Packaging Features

Cable Tie Packaging Method	Bag
Cable Tie Packaging Quantity	1000

Product Compliance

[For compliance documentation, visit the product page on TE.com>](#)

EU RoHS Directive 2011/65/EU	Compliant
EU ELV Directive 2000/53/EC	Compliant











China RoHS 2 Directive MIIT Order No 32, 2016	No Restricted Materials Above Threshold
EU REACH Regulation (EC) No. 1907/2006	Current ECHA Candidate List: JAN 2021 (211) Candidate List Declared Against: JAN 2021 (211) Does not contain REACH SVHC
Halogen Content	Low Halogen - Br, Cl, F, I < 900 ppm per homogenous material. Also BFR/CFR/PVC Free
Solder Process Capability	Not applicable for solder process capability

Product Compliance Disclaimer

This information is provided based on reasonable inquiry of our suppliers and represents our current actual knowledge based on the information they provided. This information is subject to change. The part numbers that TE has identified as EU RoHS compliant have a maximum concentration of 0.1% by weight in homogenous materials for lead, hexavalent chromium, mercury, PBB, PBDE, DBP, BBP, DEHP, DIBP, and 0.01% for cadmium, or qualify for an exemption to these limits as defined in the Annexes of Directive 2011/65/EU (RoHS2). Finished electrical and electronic equipment products will be CE marked as required by Directive 2011/65/EU. Components may not be CE marked. Additionally, the part numbers that TE has identified as EU ELV compliant have a maximum concentration of 0.1% by weight in homogenous materials for lead, hexavalent chromium, and mercury, and 0.01% for cadmium, or qualify for an exemption to these limits as defined in the Annexes of Directive 2000/53/EC (ELV). Regarding the REACH Regulation, the information TE provides on SVHC in articles for this part number is based on the latest European Chemicals Agency (ECHA) 'Guidance on requirements for substances in articles' posted at this URL: <https://echa.europa.eu/guidance-documents/guidance-on-reach>

Compatible Parts

 <p>TE Part # CAT-T3437-C6298 CM-SCE-TP MILITARY GRADE MARKERS</p>	 <p>TE Part # CAT-T3437-K1 K-TYPE TIE-ON MARKERS</p>	 <p>TE Part # CAT-T3437-H85999 HTCM-SCE-TP HIGH TEMPERATURE MARKERS</p>	 <p>TE Part # EC6518-000 13611808</p>
 <p>TE Part # EC6496-000 13611442</p>	 <p>TE Part # EC6513-000 13611707</p>	 <p>TE Part # EC6409-000 13611202</p>	 <p>TE Part # EC6453-000 13611303</p>

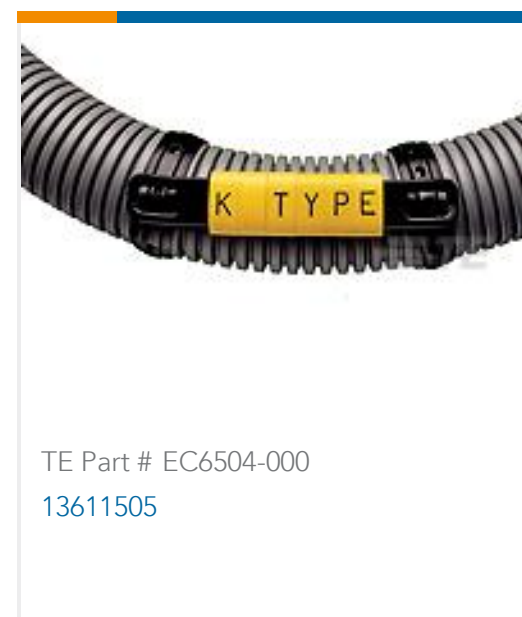

Customers Also Bought

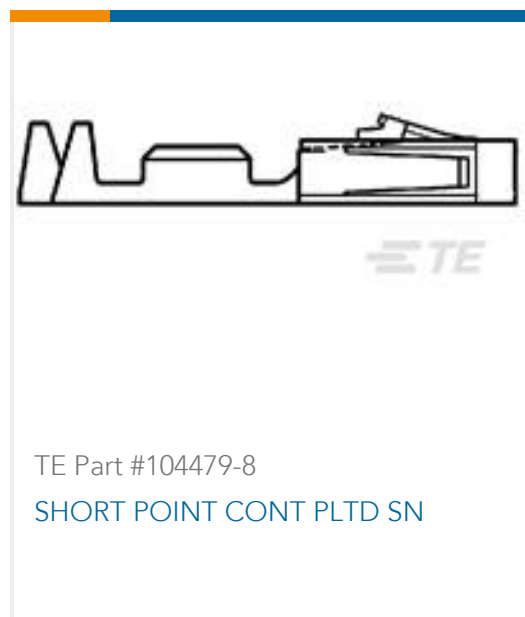

Documents



Product Drawings

CABLE TY 134X2.6 BLACK

English

Datasheets & Catalog Pages

CABLE TIES

English