

91508-1 ✓ ACTIVE

AMP

TE Internal #: 91508-1

Portable Crimp Tools, Premium Crimp Tooling, Not Releasable,
Not Adjustable, Fixed In Tool, TE Product Specification (114-)

[View on TE.com >](#)



Application Tooling > Portable Crimp Tools



Tool Grade: **Premium Crimp Tooling**

Ratchet Configuration: **Not Releasable, Not Adjustable**

Die Sets Type: **Fixed In Tool**

Specification Type: **TE Product Specification (114-)**

TE Certification: **Yes – Certificate Included**

Features

Other

Crimp Form-Wire Barrel Type	Open Barrel - F Crimp
Tool Grade	Premium Crimp Tooling
Ratchet Configuration	Not Releasable, Not Adjustable
Die Sets Type	Fixed In Tool
Specification Type	TE Product Specification (114-)
TE Certification	Yes – Certificate Included
Power Technology Type	Battery, Electric, Manual
Tooling Type	CERTI-CRIMP II, Straight Action Hand Tool

Product Compliance

[For compliance documentation, visit the product page on TE.com>](#)

EU RoHS Directive 2011/65/EU	Out of Scope
EU ELV Directive 2000/53/EC	Out of Scope
China RoHS 2 Directive MIIT Order No 32, 2016	Not reviewed for China RoHS compliance
EU REACH Regulation (EC) No. 1907/2006	Current ECHA Candidate List: JAN 2021 (211) Candidate List Declared Against: JUL 2017 (174) SVHC > Threshold: Not Yet Reviewed
Halogen Content	Not Yet Reviewed for halogen content













Solder Process Capability

Not applicable for solder process capability

Product Compliance Disclaimer

This information is provided based on reasonable inquiry of our suppliers and represents our current actual knowledge based on the information they provided. This information is subject to change. The part numbers that TE has identified as EU RoHS compliant have a maximum concentration of 0.1% by weight in homogenous materials for lead, hexavalent chromium, mercury, PBB, PBDE, DBP, BBP, DEHP, DIBP, and 0.01% for cadmium, or qualify for an exemption to these limits as defined in the Annexes of Directive 2011/65/EU (RoHS2). Finished electrical and electronic equipment products will be CE marked as required by Directive 2011/65/EU. Components may not be CE marked. Additionally, the part numbers that TE has identified as EU ELV compliant have a maximum concentration of 0.1% by weight in homogenous materials for lead, hexavalent chromium, and mercury, and 0.01% for cadmium, or qualify for an exemption to these limits as defined in the Annexes of Directive 2000/53/EC (ELV). Regarding the REACH Regulations, TE's information on SVHC in articles for this part number is still based on the European Chemical Agency (ECHA) 'Guidance on requirements for substances in articles' (Version: 2, April 2011), applying the 0.1% weight on weight concentration threshold at the finished product level. TE is aware of the European Court of Justice ruling of September 10th, 2015 also known as O5A (Once An Article Always An Article) stating that, in case of 'complex object', the threshold for a SVHC must be applied to both the product as a whole and simultaneously to each of the articles forming part of its composition. TE has evaluated this ruling based on the new ECHA "Guidance on requirements for substances in articles" (June 2017, version 4.0) and will be updating its statements accordingly.

Compatible Parts

 <p>TE Part # 350551-6 UMNL SOK 20-14 AU/PHBZ L/P</p>	 <p>TE Part # 350551-7 UMNL SOK 20-14 AU/BR L/P</p>	 <p>TE Part # 350538-7 UMNL PIN 20-14 AU/NI/BR</p>	 <p>TE Part # 350551-1 UMNL SOK 20-14 PTPBR L/P</p>
 <p>TE Part # 350551-3 UMNL SOK 20-14 PTPPHBZ L/P</p>	 <p>TE Part # 350552-1 UMNL PIN 20-14 PTPBR L/P</p>	 <p>TE Part # 350552-7 UMNL PIN 20-14 AUBR L/P</p>	 <p>TE Part # 350918-3 UMNL PIN 18-14 PTPPHBZ</p>
 <p>TE Part # 350551-2 UMNL SOK 20-14 AUBR L/P</p>	 <p>TE Part # 350537-6 UMNL SOK 20-14 .0125 AUNI/PHBZ</p>	 <p>TE Part # 350700-7 UMNL SPLIT PIN AU/NI/BR</p>	 <p>TE Part # 350538-3 UMNL PIN 20-14 .0125 PTPPHBZ</p>



Customers Also Bought

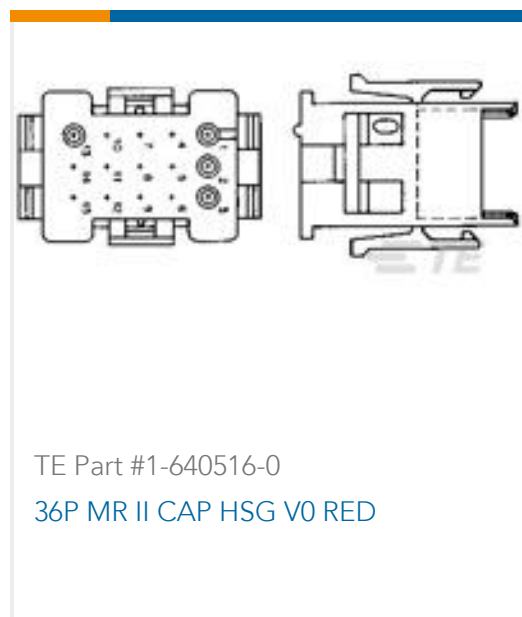
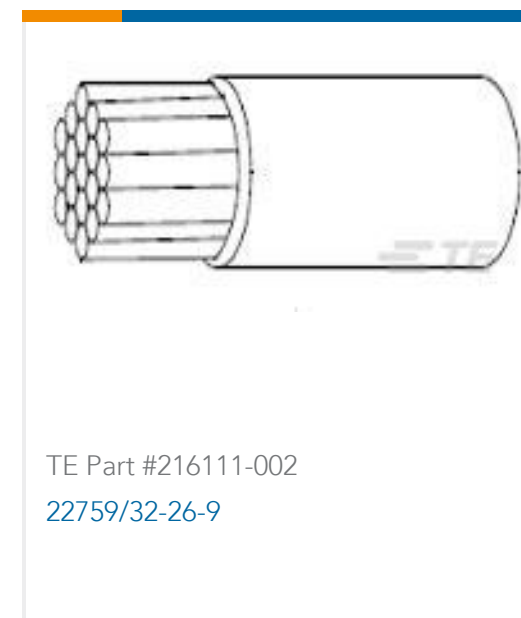
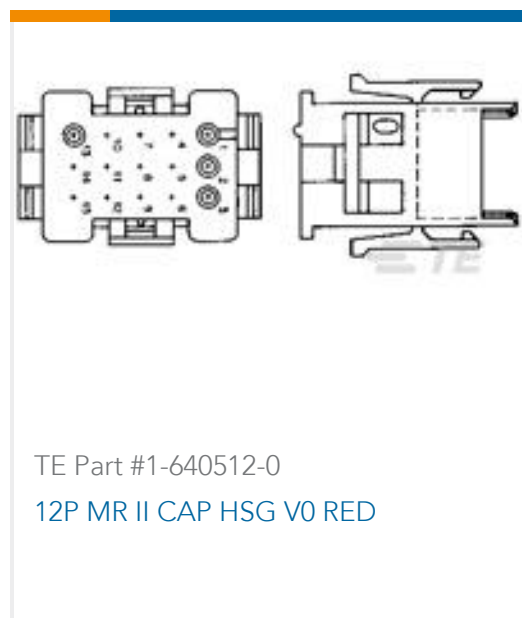

Documents



Datasheets & Catalog Pages

[CERTI-CRIMP II Premium-August-1-1773864-7](#)

English

[CERTI-CRIMP II TOOL DATA SHEET UNIVERSAL MATE-N-LOK CONTACT FAMILY](#)

English

[Crimp Term Whitepaper-Use the Right Tool 1-1773953-1](#)

English

Bottoming Dies

English

[CRIMPING WHERE FORM MEETS FUNCTION](#)

English

Instruction Sheets

[Instruction Sheet \(U.S.\)](#)

English