



Please read this document carefully before using this product. The guarantee will be invalidated if the device is damaged by not following instructions detailed in the manual. The company shall not be responsible for any damage or losses however caused, which may be experienced as a result of the installation or use of this product.

ENDA EUP SERIES PID UNIVERSAL CONTROLLER

Thank you for choosing ENDA EUP Series Universal Controller Devices.

- ▶ Dual setpoint value can be selected.
- ▶ PT100 ,J, K, L, T, S, R sensor (thermocouple) types can be selected.
- ▶ 0-20mA, 4-20mA, 0-10V, 2-10V, 0-25mV and 0-50mV input selections.
- ▶ Auto calculation for PID parameters (SELF TUNE).

Self tune for automatic PID calculation or manually enter PID parameters if known.

- ▶ Three different feature can be assigned to digital input.
- ▶ Three different feature can be assigned to F function key.
- ▶ Soft-Start feature.
- ▶ Analogue, SSR or Relay Output Control selection.
- ▶ 0-20mA and 4-20mA Analogue Output Control selection.
- ▶ Up to 16 steps Profile Control.
- ▶ A1 Relay output programmable as first Alarm or Cooling control output.
- ▶ C/A2 Relay output can be used as second Alarm or Temperature Control output.
- ▶ Heating/Cooling control selection.
- ▶ Zero point input shift.
- ▶ In case of sensor failure, periodically, auto-periodically running or relay state can be selected.
- ▶ Rs485 Modbus RTU communication protocol feature (Specify at order).



Order Code : EUP 4 2 0 - -

1 - Size	2 - Supply Voltage	3 - Modbus (Optional)
4420.....48x48x87mm	230VAC...90 - 250V AC	RS..... RS-485 Modbus Available
7420.....72x72x97mm	SM.....10-30V DC /	(Optional / Specify at order).
8420.....48x96x87mm	8-24V AC	Blank.... N/A
9420.....96x96x50mm		

Please see EUPx420 Series Modbus Address Map and Connection Diagram Guide for Modbus feature.

Input Type	Scale Range	Accuracy	
	°C	°F	
PT100 Resistance Thermometer	EN 60751 -199.9...600.0 °C	-199.9...999.9 °F	± 0,2% (for full scale) ± 1 digit
PT100 Resistance Thermometer	EN 60751 -200...600 °C	-328....1112 °F	± 0,2% (for full scale) ± 1 digit
J (Fe-CuNi) Thermocouple	EN 60584 -30.0...600.0 °C	-22.0....999.9 °F	± 0,5% (for full scale) ± 1 digit
J (Fe-CuNi) Thermocouple	EN 60584 -30....600°C	-22....1112 °F	± 0,5% (for full scale) ± 1 digit
K (NiCr-Ni) Thermocouple	EN 60584 -30.0...999.9°C	-22.0....999.9 °F	± 0,5% (for full scale) ± 1 digit
K (NiCr-Ni) Thermocouple	EN 60584 -30....1300°C	-22....2372 °F	± 0,5% (for full scale) ± 1 digit
L (Fe-CuNi) Thermocouple	DIN 43710 -30.0...600.0°C	-22.0....999.9 °F	± 0,5% (for full scale) ± 1 digit
L (Fe-CuNi) Thermocouple	DIN 43710 -30....600°C	-22....1112 °F	± 0,5% (for full scale) ± 1 digit
T (Cu-CuNi) Thermocouple	EN 60584 -30.0...400.0°C	-22.0....752.0 °F	± 0,5% (for full scale) ± 1 digit
T (Cu-CuNi) Thermocouple	EN 60584 -30....400°C	-22....752 °F	± 0,5% (for full scale) ± 1 digit
S (Pt10Rh-Pt) Thermocouple	EN 60584 -40....1700°C	-40....3092 °F	± 0,5% (for full scale) ± 1 digit
R (Pt13Rh-Pt) Thermocouple	EN 60584 -40....1700°C	-40....3092 °F	± 0,5% (for full scale) ± 1 digit
0-20mA input	-1999...+9999 (max. scale range 10000)		± 0,2% (for full scale) ± 1 digit
4-20mA input	-1999...+9999 (max. scale range 10000)		± 0,2% (for full scale) ± 1 digit
0-10V input	-1999...+9999 (max. scale range 10000)		± 0,2% (for full scale) ± 1 digit
2-10V input	-1999...+9999 (max. scale range 10000)		± 0,2% (for full scale) ± 1 digit
0-25mV input	-1999...+9999 (max. scale range 10000)		± 0,2% (for full scale) ± 1 digit
0-50mV input	-1999...+9999 (max. scale range 10000)		± 0,2% (for full scale) ± 1 digit

ENVIRONMENTAL CONDITIONS

Ambient/storage temperature	0 ... +50°C/-25 ... +70°C
Max. relative humidity	Relative humidity 80% for temperatures up to 31°C decreasing linearly to 50% relative humidity at 40°C.
Rated pollution degree	According to EN 60529; Front panel : IP65, Rear panel : IP20
Height	Max. 2000m

KEEP AWAY device from exposed to corrosive, volatile and flammable gases or liquids and **DO NOT USE** the device in similar hazardous locations.

ELECTRICAL CHARACTERISTICS

Supply	90-250V AC, 50/60Hz or 10-30VDC / 8-24VAC ±10 SMPS
Power consumption	Max. 5VA
Wiring	Power screw-terminal connections: 2.5mm ² , Signal screw-terminal connections: 1,5mm ² .
Line resistance	Max. 100 Ohm
Data retention	EEPROM (minimum 10 years)
EMC	EN 61326-1: 2013 (Performance criterion B satisfied for EN 61000-4-3 standard).
Safety requirements	EN 61010-1: 2010 (Pollution degree 2, overvoltage category II)

OUTPUTS

C/A2 Output	Relay : 250V AC, 8A (for resistive load), NO+NC (Control or Alarm2 Output selection).
A1 Output	Relay : 250V AC, 8A (for resistive load), NO (Alarm1 and Cooling Control Output selection).
ANL/SSR Output	Max. SSR Output ; 0-20mA, 4-20mA, 24V 20mA. Max. load resistance ; 600 Ohm (12 bit 0.2% accuracy).
Life expectancy for relay	Without load 30.000.000 switching; 250V AC, 8A (resistive load) 300.000 switching.

CONTROL

Control type	Single Setpoint and Alarm Control.
Control algorithm	On-Off / P, PI, PD, PID (selection).
A/D converter	14 bit.
Sampling time	Min. 100ms.
Proportional band	Can be adjusted between %0.0 and %100.0 . If Pb=%0.0 , ON-OFF control is selected.
Control period	Can be adjusted between 1 and 125secs.
Hysteresis	Can be adjusted between 1 and 50°C/F.
Output power	Setpoint value ratio can be adjusted between %0 and %100 .

HOUSING

Housing type	Suitable for flush-panel mounting according to DIN 43 700.
Dimensions	EUP4420 : W48xH48xD87mm, EUP7420 : W72xH72xD97mm, EUP8420 : W48xH96xD87mm, EUP9420 : W96xH96xD50mm.
Weight	Approx. 400g (250g for EUP4400) After packing.
Enclosure material	Self extinguishing plastics

DO NOT clean the device with solvent (thinner, gasoline, acid etc.) and / or abrasive cleaning agents.

ENTERING TO PROGRAMMING MODE

If **SET** key is pressed while holding **F** key, the "Programming Mode" is entered.

Page 3

A **CLo** **CLo** = Lower limit for C/A2 Output control, setpoint value. Can be adjusted between 0 and C_{SH} .

CSh **CSh** = Upper limit for C/A2 Output Control, setpoint value. Can be adjusted between **CLo** and Upper scale value.

Cpb **Cpb** = Proportional band value for C/A2 Output. Can be adjusted between 0.0% and 100.0%. If **CPb** parameter set to 0.0%, On-Off control will be accepted.

A1 **CHY5** **CHY5** = Hysteresis value for C/A2 Output. Can be adjusted between between 1°C and 50°C.

A2 **Cti** **Cti** = Integral value for C/A2 Output. Can be adjusted between 0.0 and 100.0 minutes. If **Cti** parameter set to 0.0, integral will be disabled.

A2 **Ctd** **Ctd** = C/A2 Output Derivative value. Adjustable between 0.00 and 25.00 minutes. If **Ctd** parameter set to 0.0, derivative will be disabled.

A2 **Cct** **Cct** = C/A2 Output periodic time duration. Adjustable between 1 and 250 seconds.

A2 **CP5t** **CP5t** = C/A2 output power percentage at A1 set value. Can be adjusted between 0% and 100%.

A2 **CEct** **CEct** = Control type selection for sensor failures. If **EP5** selected, controlling will be performed to according to **LEP5** proportional control parameter. If **Aut** is selected, controlling will be performed to last recorded set value percentage before probe failure.

A3 **CEP5** **CEP5** = C/A2 Output power percent selection on probe failure. Can be adjusted between %0 and %100. If **CPb** set to 0.0 (On/Off Control) and **CEP5** set to 0, output will be OFF, on failure. If **CEP5** set to different value from 0, output will be ON, in case of failure.

55t5 **55t5** = Soft start timer set value. This parameter determines how many minutes will be reached to the setpoint value on power-up. Can be adjusted between 0 and 250 minutes. If set to 0, the soft start feature will be canceled and the setpoint value will be reached maximum speed.

CEYP **CEYP** = Output controlling type selection
HEAt = Heating control
COoL = Cooling control

B **ALo** **ALo** = Alarm1 set value lower limit. Can be adjusted between 0 and **ALH** parameter value.

ALH **ALH** = Alarm1 set value upper limit. Can be adjusted between **ALo** and upper scale value.

A1H4 **A1H4** = Hysteresis of the Alarm1 output. Can be adjusted between 1 and 50°C.

A1EP **A1EP** = Alarm1 types. Six alarm types can be selected.
indE = Independent alarm
dE = Deviation alarm
bAnd = Band alarm
bAni = Band with inhibition
inCo = A1 output independent cooling control
rCEo = A1 output relative cooling control

B1 **ALSt** **ALSt** = Status selection for Alarm1 Output. If **H** is selected, A1 output is above the Alarm1 set value; ON. If **Lo** is selected, A1 Output is above the Alarm1 set value; OFF.

B1 **A1Er** **A1Er** = Alarm1 condition selection on probe failure
on = A1 Output is ON, in case of probe failure.
oFF = A1 Output is OFF, in case of probe failure.

B2 **A1Pb** **A1Pb** = A1 Output, proportional band value. Can be adjusted between 0% and 100%. If **A1Pb** Parameter set to %, On-Off control will be accepted.

B3 **A1ti** **A1ti** = A1 Output, integral value. Can be adjusted between 0.0 and 100.0 minute. If **A1ti** parameter set to 0.0, integral will be disabled.

B3 **A1td** **A1td** = A1 output derivative value. Can be adjusted between 0.00 and 25.00 minutes. If **A1td** parameter set to 0.00, devirative will be disabled.

B3 **A1CT** **A1CT** = A1 Output Period Time. Can be adjusted between 1 and 250 seconds.

B3 **A1P5** **A1P5** = A1 output power percentage at A1 set value. Can be adjusted between 0% and 100%.

B2 **A1EP** **A1EP** = A1 Output power percent selection on probe failure. Can be adjusted between 0% and 100%.

C **AL2o** **AL2o** = Alarm2 set value lower limit. Can be adjusted between 0 and **AL2H** parameter value.

AL2H **AL2H** = Alarm2 set value upper limit. Can be adjusted between **AL2o** and upper scale value.

A2H4 **A2H4** = Hysteresis of the Alarm2 output. Can be adjusted between 1 and 50°C.

A2EP **A2EP** = Alarm2 types. Four alarm types can be selected.
indE = Independent alarm
dE = Deviation alarm
bAnd = Band alarm
bAni = Band with inhibition

A2St **A2St** = Status selection for Alarm2 Output. If **H** is selected, A2 output is above the Alarm2 set value; ON. If **Lo** is selected, A2 Output is above the Alarm2 set value; OFF.

A2Er **A2Er** = Alarm2 condition selection on probe failure
on = A2 Output is ON, in case of probe failure.
oFF = A2 Output is OFF, in case of probe failure.

D **Conf** **Conf** = Profile Control Selection.
oFF = Standard controlling.
on = Profile controlling.

D1 **inPE** **inPE** = Input Type Selection. Please see "Input Type Selection Table" for details at the bottom of this page.

D1 **Unite** **Unite** = Temperature Unit Selection. Selectable between °C = °C and °F = °F.

FLtr **FLtr** = Coefficient of Digital Filter. Provides to filter for displayed value. Adjustable between 1 and 200. If this parameter set to 1, digital filter runs quickly. If the parameter is set to 200, filter runs slowly. This parameter value should be increased in interference environments.

Co5E **Co5E** = Control output selection.
C-A2 = C/A2 (Relay) output selection.
55F = SSR output selection.
0-20 = 0-20 mA analogue output
4-20 = 4-20 mA analogue output
RCoN = Control output selection for motorized valve.

D2 **RCoL** **RCoL** = Full opening time duration for Motorized Valve. Can be adjusted between 2 and 300 seconds.

D2 **RCCT** **RCCT** = Controlling Period for Motorized Valve. Valve control output period as a percentage of **RCoL** time duration. Can be adjusted between 1% and 50%. This parameter adjusts how often the valve is operated, preventing unnecessary operation.

oFF5 **oFF5** = Offset Value. The offset value is added to the measurement value. This feature is used to eliminate errors that may occur due to the distance from the measuring probe to the measuring point. Can be adjusted between -99 and 100°C. Default value is 0.

D3 **dAdr** **dAdr** = RS485 Connection Address. Can be adjusted between 1 and 247.

D3 **bAud** **bAud** = ModBus Baud Rate. Can be adjusted to off, 2.40, 4.80, 9.60, 19.20 and 38.40.

dinL **dinL** = Digital input setting parameter.
nonE = Digital input is closed.
C25R = if digital input is activated, 2nd set value is used.
nAnu = Manual mode start in case of digital outputs are active and rational output generated according to period value in **CCT** parameter and percentage value in **55t5** parameter.
d5Pa = If the digital input is activated, only temperature value will be indicated.

FtEL **FtEL** = Function key setting
nonE = Function key is OFF.
C25R = 2nd. set value can be used by using function key.
nAnu = Manual mode can be accessed by using function key.
d5Pa = Temperature value will be indicated by using function key.

D4 **RoLo** **RoLo** = Minimum Output Percent for Analog Output. Can be adjusted between 0 and **RoHi**.

D4 **RoHi** **RoHi** = Maximum Analog Output Percent for Analog Output. Can be adjusted between **RoLo** and 100.

Input Type Selection Table

inPE = Input Type Selection

Resistance thermometer:
PE0 = PT100 with decimal display (w.D.)
PE = PT100 without decimal display (w.o.D.)

Thermocouple:
J0 = J Typ w.D.
J = J Typ w.o.D.
K0 = K Typ w.D.
K = K Typ w.o.D.
L0 = L Typ w.D.
L = L Typ w.o.D.
T0 = T Typ w.D.
T = T Typ
S = S Typ
R = R Typ

Analog output:
0-20 = 0-20 mA
4-20 = 4-20 mA
0-10 = 0-10 V
2-10 = 2-10 V
0-25 = 0-25 mV
0-50 = 0-50 mV

Changes to this parameter may cause some parameter values to change.

ANNOTATIONS

Information tracking method about the parameters

A B C D ●●●●

A1
A2
A3

On the device screens shown on this page;
 - First line indicates the parameter name,
 - Second line indicates the current parameter's value.
 At the same time, the value shown in the second line is the default value of the device.

A1td 0 ⇒ Parameter name
 ⇒ Parameter value (default value)

RUNNING MODE

During in "Programming Mode", if no key is pressed for 20 sec, settings automatically saved and device returns to the "Running Mode" (to the home screen). Alternatively, by pressing **SET** key "Running Mode" is entered and by pressing both **CIA SET** **F** keys at once, settings automatically saved and device returns to the "Running Mode" (to the home screen).

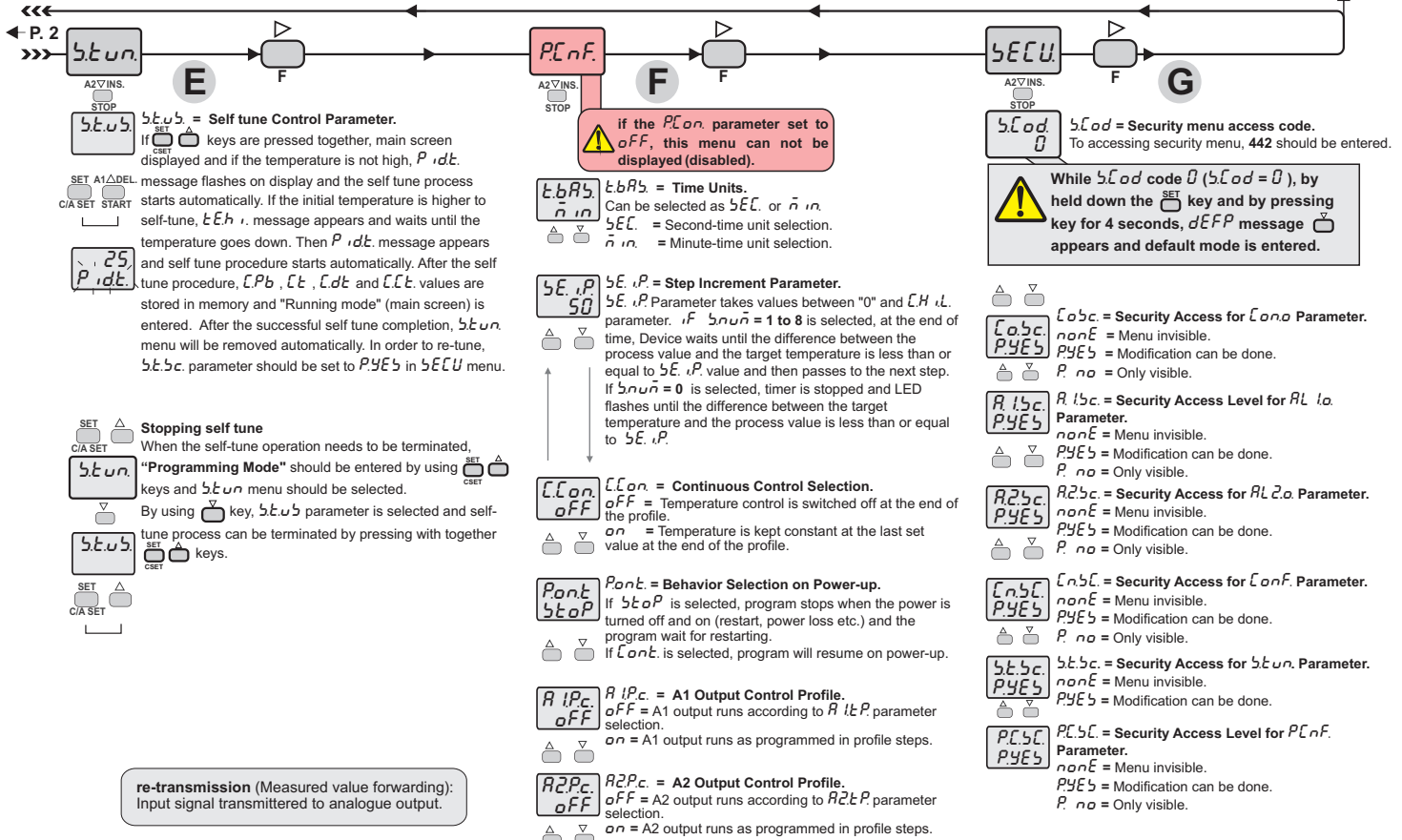
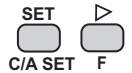

re-transmission (Measured value forwarding):
 Input signal transmitted to analogue output.

- D**
- D5** **ftrb nonE**
ftrb = Control Parameter for Retransmission Output.
nonE = Retransmission OFF.
0-20 = 0-20mA Analog retransmission output.
4-20 = 4-20 mA Analog retransmission output.
 - D6** **f.oL o**
f.oL o = Lower Scale Value for Retransmission Output.
 Can be adjusted between lower scale value and **f.oH i**.
 - D6** **f.oH i**
f.oH i = Upper Scale Value for Retransmission Output.
 Can be adjusted between **f.oL o** and upper scale value.
 - D7** **dP5E**
dP5E = Decimal Point selection for mA Inputs.
 Can be adjusted between 0 and 0.000
 - D7** **u5L o**
u5L o = Lower Scale Value for mA Inputs.
 Can be adjusted between -1999 and (**u5H i** - 10).
 - D7** **u5H i**
u5H i = Upper Scale Value for mA Inputs.
 Can be adjusted between (**u5L o** + 10) and 9999.

- D1** Changes to this parameter may cause some parameter values to change.
 - D2** This parameter can be displayed if the **Co5E** Parameter set to **Rcon**.
 - D3** This parameter available in RS485-Modbus devices only.
 - D4** This parameter can be displayed if the **Co5E** parameter set to "0-20" or "4-20".
 - D5** This parameter can be displayed if the **Co5E** parameter set to "C-R2".
 - D6** This parameter can be displayed if the **Co5E** parameter set to "C-R2" and if the **ftrb** parameter set to "0-20" or "4-20".
 - D7** This parameter can be displayed if the **inPE** parameter set to "mV", "mA" or "V".
- Please see EUPx420 Series Modbus Address Map and Connection Diagram Guide for Modbus feature.**

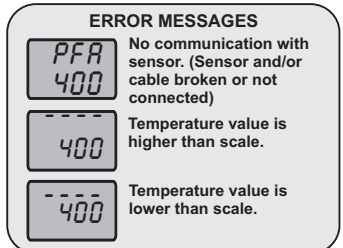
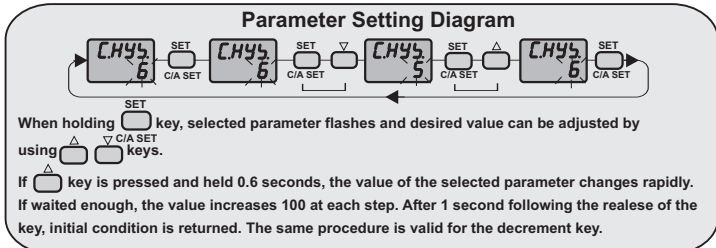

TERMS AND DISPLAY

(1) Indicates measured value and set values in "Running Mode". Indicates the parameters and names in "Programming Mode".

(2) Lights up, if timer is displayed and flashes while timer is running.

(3) Increment key in "Running and Programming Mode". Parameter selection key in "Programming Mode".

(4) Decrement key. By pressing this key in "Running Mode", software version can be displayed. Parameter selection key in "Programming Mode".

(5) Selectable function key "Running Mode". Menu selection key in "Programming Mode".

(6) Control and Alarm set key in "Running Mode". Parameter set key in "Programming Mode"

(1) PV and SV indicators	PV 7 Segment 4 digits red LED , SV 7 Segment 4 digits yellow LED display. Character height : PV and SV display 7.2M
(2) Timer Indicator	Indicates during the timer displayed and flashes while timer running in "Profile Mode".
(3),(4),(5),(6) Keypads	Micro switch
(7) Status Indicators	Red LED indicators for Control, Alarm1 and Analog/SSR outputs.

SETTING OPTIONS IN RUNNING MODE

SETTING UP ALARM CONTROL AND SETPOINT VALUES

If one of the *d inc.* or *F.F.E.c.* parameters are set to the *C25R* value, this parameter can be displayed.

If the *C.05E* parameter is set to SSR out, this parameter can be displayed.

If one of the *d inc.* or *F.F.E.c.* parameters are set to the *nRRn* and if *C. Pb* is different from 0, this parameter can be displayed.

SETTING UP TIMER/THERMOSTAT SETPOINT VALUES

R205 Parameter:
This parameter appears if the *C.05E* parameter is set to *5rr*, *0-20* or *4-20* and which the *R2Pc* parameter is set to *on*. If *R205* is set to *on*, A2 output state becomes on. At the end of the duration or if STOP key is pressed, A2 state will be off (this parameter is described in PC16 coils at ModBus address map).

ADJUSTING PROFILE STEP PARAMETERS

If *P.c.a* parameter is on, this section can be entered.

If **SET** key is pressed in "Running Mode", step programming menu can be entered.

500 (CIA2) / **40** (A1) = Target temperature value for 1st step.

By hold down to **SET** key, desired value can be adjusted with **A1 DEL** and **A2 VINS** keys.

t.01 (CIA2) / **40** (A1) = Time value for 1st step.

By hold down to **SET** key, desired value can be adjusted with **A1 DEL** and **A2 VINS** keys.

If **START** key is pressed, upper display indicates the step number and lower display indicates the **RL-5** message. In this point by hold down to **SET** key, A1 output can be set to on or off with **A1 DEL** key. Also, A2 output can be set to on or off with **A2 VINS** key.

Delete or insert from ramp steps:
If **START** key is hold down for 2 s., step number flashes at the upper display. During holding down the **START** key and by pressing to **A1 DEL** key, **dEL** message displayed and current profile will exited and next step value shifted up. Or, if **A2 VINS** key is pressed, **n5** message appears and the next steps are shifted to the next and a new step is inserted. When keys are released, new values of the step are displayed.

The procedure for further ramp steps is repeated as described above.

t.E.16 (CIA2) / **500** (A1) = Target temperature value for 16th step.

By holding down to **SET** key, desired value can be adjusted by using **A1 DEL** and **A2 VINS** navigation keys.

t.i.16 (CIA2) / **40** (A1) = Time value for 16th step.

By holding down to **SET** key, desired value can be adjusted by using **A1 DEL** and **A2 VINS** navigation keys.

ERROR MESSAGES

PFA No communication with sensor. (Sensor and/or cable broken or not connected)

400 Temperature value is higher than scale.

-400 Temperature value is lower than scale.

Attention! In order for the alarm outputs to function as set in the profile steps, *R IPc* and *R2Pc* parameters must be set to *on* before applying the profile.

MOTORIZED VALVE CONNECTION AND SETTINGS

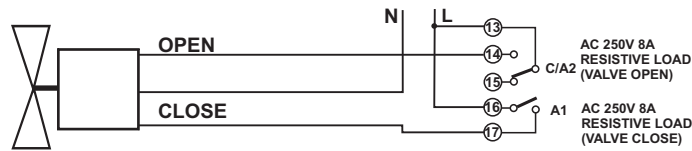

Motorized valve connection must be applied as shown figure above (if the motorized valve electrical values are incompatible with EUPx420 contact output values, an additional contactor must be connected). And $L_{o.s.E.}$ parameter in the EUPx420 must be selected as $R_{c.o.n.}$. Full opening time of the motorized valve connected to the device is entered in $R_{c.o.E.}$ parameter as seconds. Full opening time must be entered to $R_{c.L.E.}$ parameter as percentage for motorized valve running-up time.

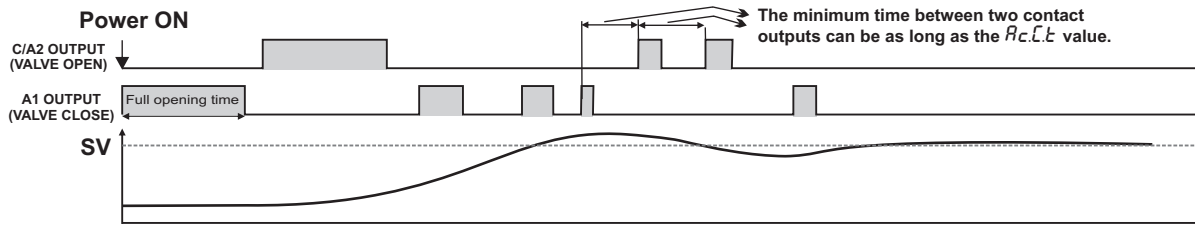

ALARM1 AND ALARM2 OUTPUT TYPES

Independent Alarm $R_{i.t.P.} = ind.E$

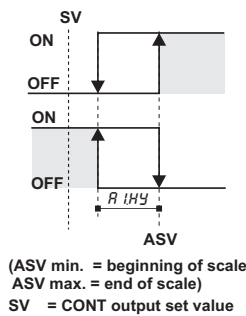

Deviation Alarm $R_{i.t.P.} = d.E.$

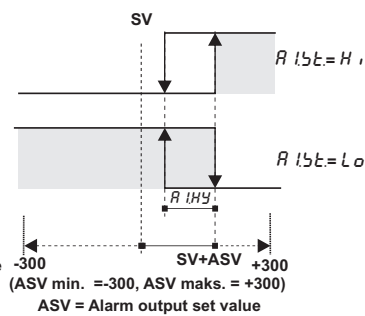

Band Alarm $R_{i.t.P.} = b.A.n.d$

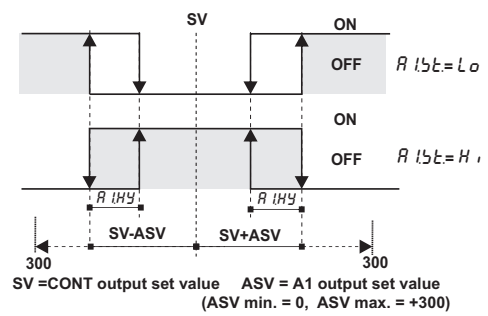

Band Alarm With Inhibition $R_{i.t.P.} = b.A.n.i.$

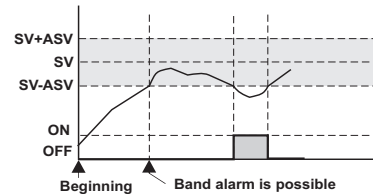
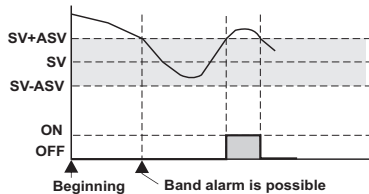

TIMER / THERMOSTAT OUTPUT DIAGRAMS

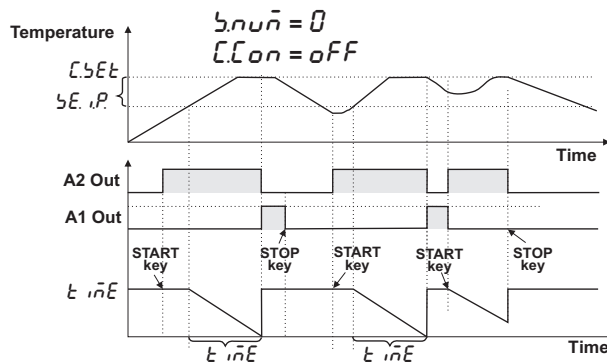
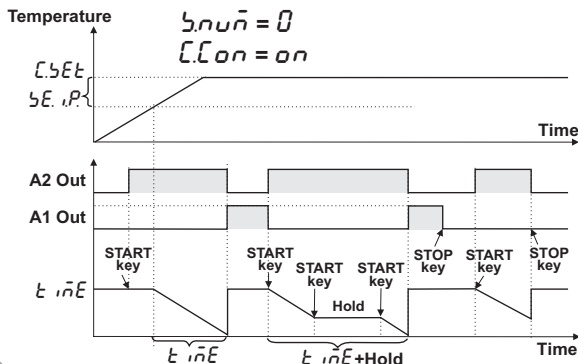

A2 Output runs if the $L_{o.s.E.}$ parameter is set to 55, 0-20 or 4-20 and with the $R_{2.P.c.}$ parameter is set to on

PROFILE CONTROL OUTPUT DIAGRAMS

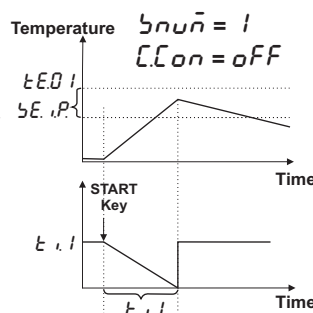
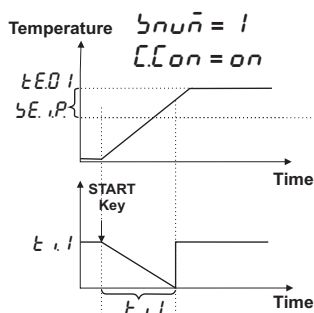

! $L_{o.s.E.}$ must be set to 1 for single step program.

MULTI-STEP PROFILE CONTROL OUTPUT GRAPHICS

Diagram-5

	Step1	Step2	Step3	Step4	Step5
Target Temperature	$t_{E.01} = 100$	$t_{E.02} = 100$	$t_{E.03} = 300$	$t_{E.04} = 300$	$t_{E.05} = 100$
Time	$t_{i.01} = 30$	$t_{i.02} = 20$	$t_{i.03} = 60$	$t_{i.04} = 40$	$t_{i.05} = 60$
A1	ON	OFF	OFF	ON	OFF
A2	OFF	ON	OFF	ON	OFF

! $b_{n.0n}$ parameter should be set to 5 for five step program.

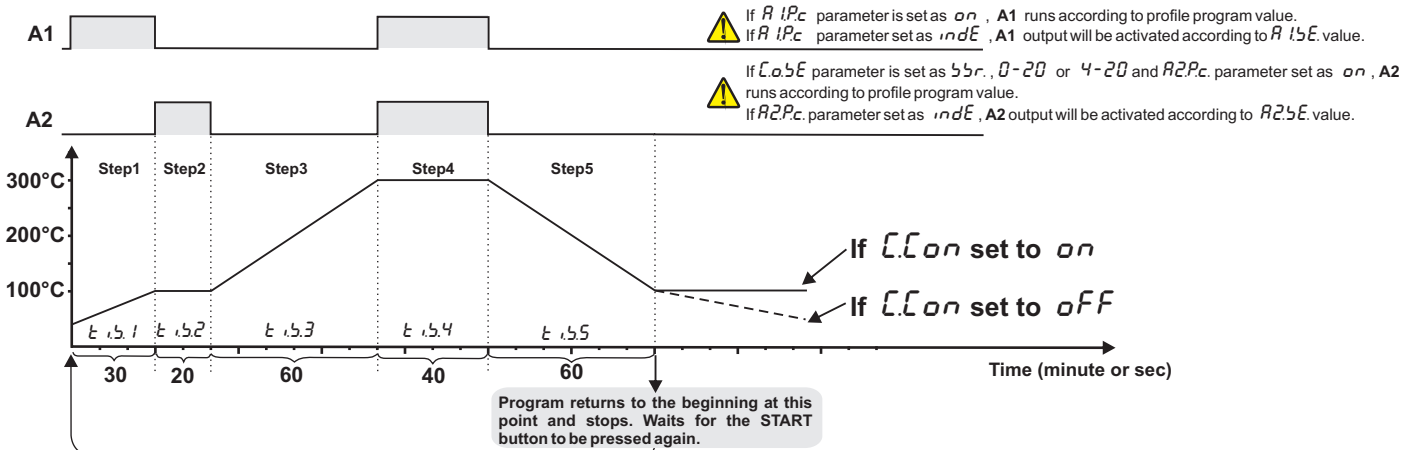

CONNECTION DIAGRAM

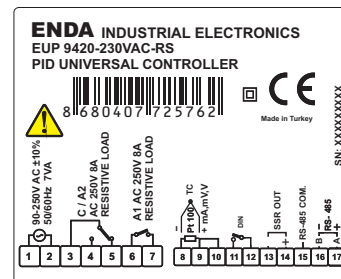
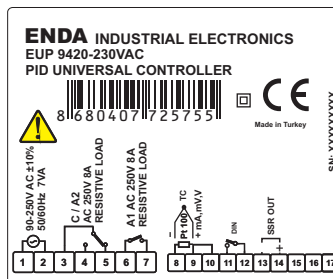
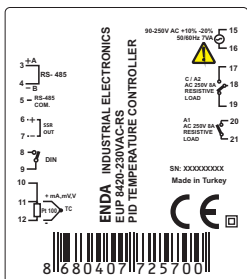
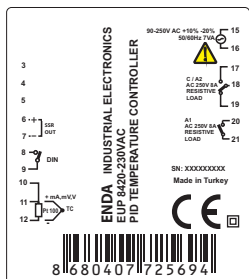
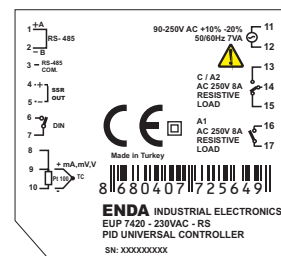
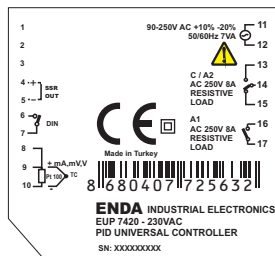
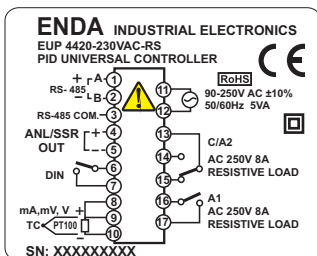
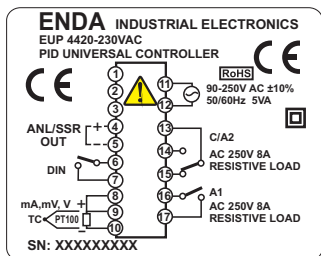

NOTE :

SUPPLY VOLTAGE

184-253V AC	EUP4420	EUP7420	EUP8420	EUP9420
or	(11)	(11)	(15)	(1)
21.6-26.4V AC				
50/60Hz 5VA	(12)	(12)	(16)	(2)

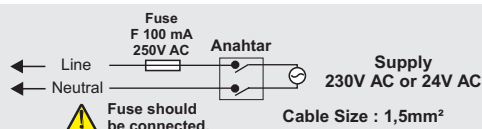

! Equipment is protected throughout by DOUBLE INSULATION.

SENSOR INPUT:

For J-K-T-S and R Thermocouples: Use the correct compensating cable. Do not make any supplement to cables. Connect the thermocouple cables to the right places at the input terminal.

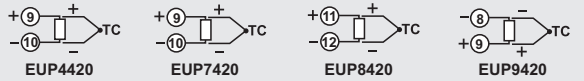

For resistance (PT100) Sensor: In order to using 2-wire resistance sensors (PT100), 8th and 9th terminals must be short circuited on EUP4420, EUP7420 and EUP9420 devices. Also on EUP8420 devices, 10th and 11th terminals must be short circuited. Please check connection diagrams carefully.



MODBUS CONNECTION

! Please see EUPx420 Series Modbus Address Map and Connection Diagram Guide for Modbus feature.

* MODBUS CONNECTION DIAGRAM

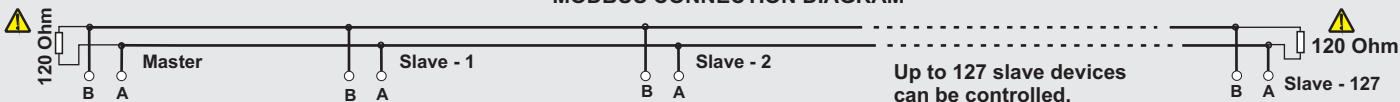

! Termination should be accomplished by attaching 120 Ohm resistors to the start and at the end of the communication line.

* Applies to devices with Modbus function.

DIMENSIONS

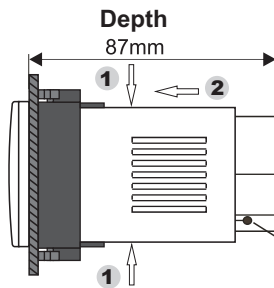
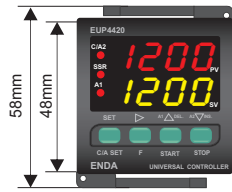

To removing the device from the panel:
- While pressing both side of the device in direction 1 and push it in direction 2.

Connection Cables
Ambient temperature sensor

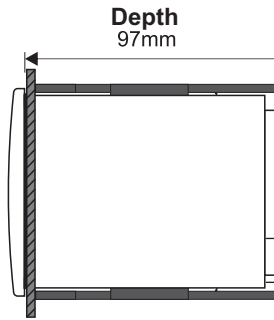
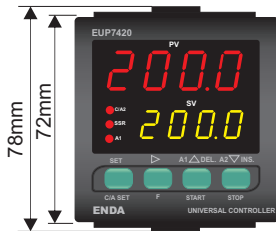
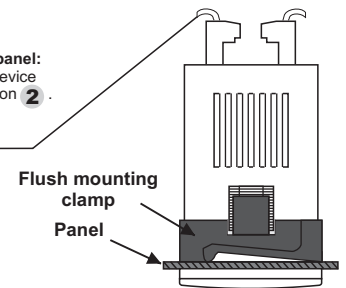

To removing the device from the panel:
- While pressing both side of the device in direction 1 and push it in direction 2.

Connection Cables
Ambient temperature sensor

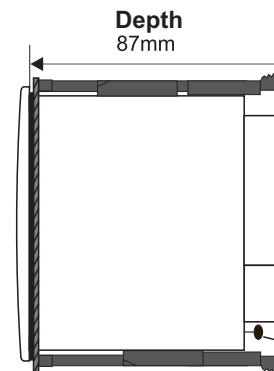
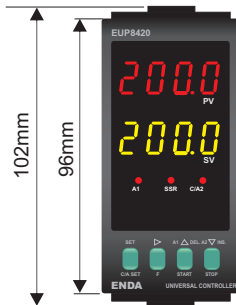
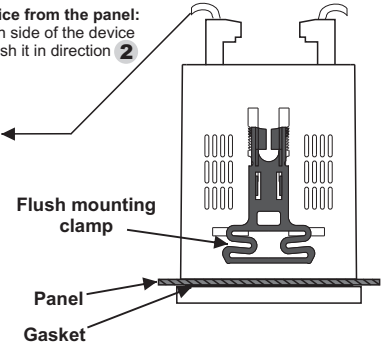

To removing the device from the panel:
- While pressing both side of the device in direction 1 and push it in direction 2.

Connection Cables
Ambient temperature sensor

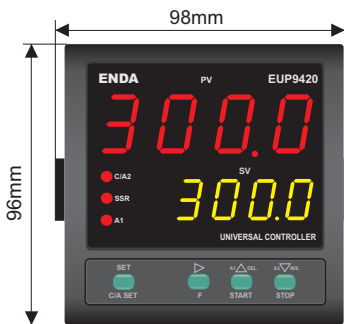
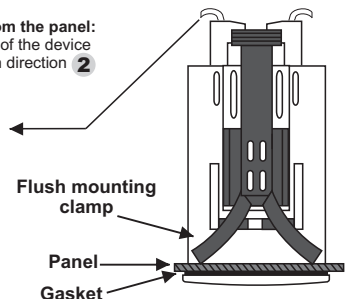

To removing the device from the panel:
- While pressing both side of the device in direction 1 and push it in direction 2.

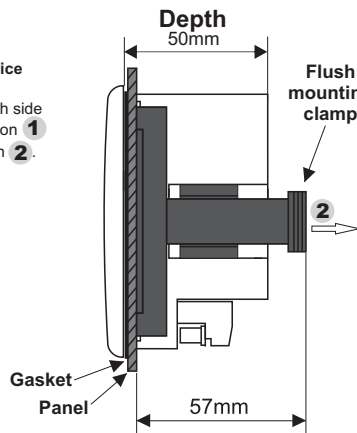

ENDA EUPx420 Series PID Temperature Controllers are intended for installation in control panels. Make sure that the device is used only for intended purpose. The shielding must be grounded on the instrument side.

During an installation, all of the cables that are connected to the device must be free of energy. The device must be protected against inadmissible humidity, vibrations, severe soiling. Make sure that the operation temperature is not exceeded. All input and output lines that are not connected to the supply network must be laid out as shielded and twisted cables. These cables should not be close to the power cables or components. The installation and electrical connections must be carried on by a qualified staff and must be according to the relevant locally applicable regulations.

PANEL CUT-OUT

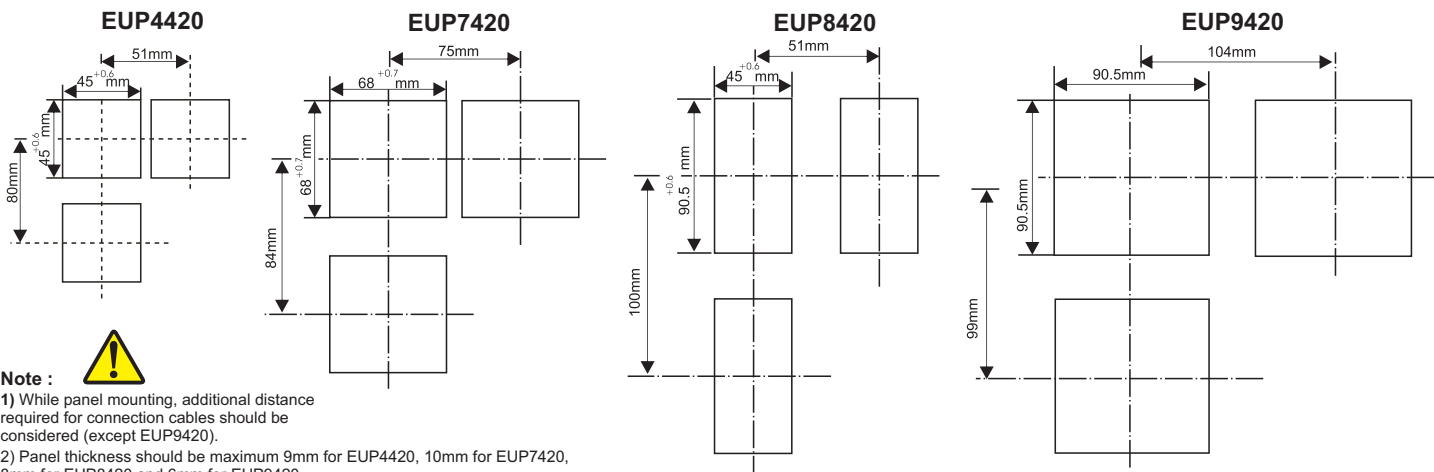

Note :

- 1) While panel mounting, additional distance required for connection cables should be considered (except EUP9420).
- 2) Panel thickness should be maximum 9mm for EUP4420, 10mm for EUP7420, 8mm for EUP8420 and 6mm for EUP9420.
- 3) If there is no free space at back side of the device, it would be difficult to remove it from the panel. Required minimum free spaces :
EUP4420 = 100mm, EUP7420 = 90mm, EUP8420 = 90mm, EUP9420 = 60mm.

END A EUPx420 SERIES PID TEMPERATURE CONTROLLER MODBUS PROTOCOL ADDRESS MAP

1.1 Memory Map for Holding Registers

	Parameter Number	Holding Register Address Decimal (Hex)	Data Type	Data Content	Read / Write Permission	Parameter Name	Default Value
Control Output Parameters	H0	0000d (0000h)	Word	Control output, temperature setpoint value	R/W	C15E	400
	H1	0001d (0001h)	Word	Control output, 2nd temperature setpoint value	R/W	C25E	400
	H2	0002d (0002h)	Word	Control output, minimum setpoint value	R/W	C5Lo	0
	H3	0003d (0003h)	Word	Control output, maximum setpoint value	R/W	C5Hi	600
	H4	0004d (0004h)	Word	Control output, proportional band setpoint value (Adjustable between 0.0% and 100.0%)	R/W	C.Pb	4
	H5	0005d (0005h)	Word	Control output, hysteresis value (Adjustable between 1 and 50 °C or °F)	R/W	CHYS	2
	H6	0006d (0006h)	Word	Control output, integral time (Adjustable between 0.1 and 100.0 minute)	R/W	C.ti	40
	H7	0007d (0007h)	Word	Control output, derivative time (Adjustable between 0.01 and 10.00 minute)	R/W	C.td	100
	H8	0008d (0008h)	Word	Control output, time period setpoint value (Adjustable between 1 and 125 second)	R/W	C.ct	20
	H9	0009d (0009h)	Word	Control output, set value power ratio (Adjustable between 0% and 100%)	R/W	CCPS	0
	H10	0010d (000Ah)	Word	Control output energy percentage in case of sensor error (can be set between 0% to 100%)	R/W	CEPS	0
A1 Output Parameters	H11	0011d (000Bh)	Word	Control output, soft start value	R/W	5555	0
	H12	0012d (000Ch)	Word	Alarm1 output temperature setpoint value	R/W	A15E	500
	H13	0013d (000Dh)	Word	Alarm1 output minimum setpoint value limit	R/W	A15L	0
	H14	0014d (000Eh)	Word	Alarm1 output maximum setpoint value limit	R/W	A15H	600
	H15	0015d (000Fh)	Word	Alarm1 output proportional band set value (Adjustable between 0.0% and 100.0%)	R/W	A1Pb	0
	H16	0016d (0010h)	Word	Alarm1 output hysteresis value (Adjustable between 1 and 50 °C or °F)	R/W	A1HY	2
	H17	0017d (0011h)	Word	Alarm1 output, integral time (Adjustable between 0.1 and 100.0 minute)	R/W	A1ti	0
	H18	0018d (0012h)	Word	Alarm1 output, derivative time (Adjustable between 0.01 and 10.00 minute)	R/W	A1td	0
	H19	0019d (0013h)	Word	Alarm1 output, time period setpoint value (Adjustable between 1 and 125 second)	R/W	A1ct	20
	H20	0020d (0014h)	Word	Alarm1 output, set value power ratio (Adjustable between 0% and 100%)	R/W	A1PS	0
	H21	0021d (0015h)	Word	Alarm1 output, set value power ratio in case of sensor failure (Adjustable between %0 and %100)	R/W	A1EP	0
H22	0022d (0016h)	Word	Alarm1 output type selection (Values can be given from 0 to 4) (0 = Independent alarm, 1 = Deviation alarm, 2 = Band alarm, 3 = Active alarm after in band time, 4 = Alarm1 output, cooling control selection)	R/W	A1tP	0	
A2 Output Parameters	H23	0023d (0017h)	Word	Alarm2 output, temperature setpoint value	R/W	A25E	500
	H24	0024d (0018h)	Word	Alarm2 output minimum setpoint value limit	R/W	A25L	0
	H25	0025d (0019h)	Word	Alarm2 output maximum setpoint value limit	R/W	A25H	600
	H26	0026d (001Ah)	Word	Alarm2 output, hysteresis value (Adjustable between 1 and 50 °C or °F)	R/W	A2HY	2
	H27	0027d (001Bh)	Word	Alarm2 output type selection (Values can be given from 0 to 3) (0 = Independent alarm, 1 = Deviation alarm, 2 = Band alarm, 3 = Active alarm after in band time)	R/W	A2tP	0
Configuration Parameters	H28	0028d (001Ch)	Word	Input selection number (0 = PT100 Decimal, 1 = Pt100 Non-decimal, 2 = J Decimal, 3 = J Non-decimal, 4 = K Decimal, 5 = K Non-decimal, 6 = L Decimal, 7 = L Non-decimal, 8 = T Decimal, 9 = T Non-decimal, 10 = S Non-decimal, 11 = R Non-decimal, 12 = 0-20mA, 13 = 4-20mA, 14 = 0-10V, 15 = 2-10V, 16 = 0-25mV, 17 = 0-40mV)	R/W	inpE	5
	H29	0029d (001Dh)	Word	ModBus device address (Adjustable between 1 and 247)	R/W	dAdr	1
	H30	0030d (001Eh)	Word	Modbus communication speed (Baudrate) (0 = Modbus cancel, 1 = 2400 bps, 2 = 4800 bps, 3 = 9600 bps, 4 = 19200 bps, 5 = 38400 bps)	R/W	bAud	3
	H31	0031d (001Fh)	Word	Digital filter coefficient (Adjustable between 1 and 200, 1 = filter is disable)	R/W	FLtr	10
	H32	0032d (0020h)	Word	Control output, selection value (0 = C/A2 Control output selection, 1 = SSR/ANL is SSR, 2 = SSR/ANL is 0-20mA, 3 = SSR/ANL is 4-20mA. ATTENTION !! H42 parameter will be 0 if this parameter set to different from 0.	R/W	C.o5E	0
	H33	0033d (0021h)	Word	Analog output minimum out percentage	R/W	RoLo	0
	H34	0034d (0022h)	Word	Analog output maximum out percentage		RoHi	100
	H35	0035d (0023h)	Word	Offset value		oFF5	0
	H36	0036d (0024h)	Word	Function control parameter. (23040d (5A00h) self tune stops when this value is entered) (23041d (5A01h) self tune starts when this value is entered) (23042d (5A02h) returns to factory defaults when this value is entered)		----	0
	H37	0037d (0025h)	Word	Full opening time duration for Motorized Valve. Can be adjusted between 2 and 300 seconds.		Acc.t	20
	H38	0038d (0026h)	Word	Controlling Period for Motorized Valve. Can be set between 1% to %50 by dependent on H37 parameter.		Acc.ct	20

END A EUPx420 SERIES PID TEMPERATURE CONTROLLER MODBUS PROTOCOL ADDRESS MAP

1.1 Memory Map for Holding Registers (continue)

Configuration Parameters	Parameter Number	Holding Register Address Decimal (Hex)	Data Type	Data Content	Read / Write Permission	Parameter Name	Default Value
	H40	0040d (0028h)	Word	Digital input control parameter (0 = Digital input off, 1 = 2nd set value can be selected by digital input, 2 = Manual mode can be entered via digital input, 3 = Can be switched to display mode via digital input)	R/W	<i>d.inC.</i>	0
	H41	0041d (0029h)	Word	Function key control parameter (0 = Function key off, 1 = 2nd Set value can be selected by function key, 2 = Manual mode can be entered by using function key, 3 = Can be switched to display mode by using function key)	R/W	<i>Ft.EC.</i>	0
	H42	0042d (002Ah)	Word	Retransmission output control parameter: If this parameter is 0, Retransmission output; off If this parameter is 1, Analog output; 0-20mA Retransmission output If this parameter is 2, Analog output; 4-20mA Retransmission output ATTENTION!! To setting up this parameter, H32 parameter must be set to 0.	R/W	<i>r.trb.</i>	0
	H43	0043d (002Bh)	Word	Retransmission output lower scale value.	R/W	<i>r.oLo.</i>	0
	H44	0044d (002Ch)	Word	Retransmission output upper scale value.	R/W	<i>r.oHi.</i>	600
	H45	0045d (002Dh)	Word	Decimal Point selection for mA anv V inputs.	R/W	<i>d.PbE.</i>	0
	H46	0046d (002Eh)	Word	User defined lower scale value for 0-20mA, 4-20mA, 0-10V and 2-10V input selections	R/W	<i>u.bLo.</i>	0
	H47	0047d (002Fh)	Word	User defined upper scale value for 0-20mA, 4-20mA, 0-10V and 2-10V input selections	R/W	<i>u.bHi.</i>	9999
	H48	0048d (0030h)	Word	Control output menu, security parameter (0 = Menu invisible, 1 = Menu programmable, 2 = Menu only visible)	R/W	<i>C.o.b.c.</i>	1
	H49	0049d (0031h)	Word	Alarm1 output menu security parameter (0 = Menu invisible, 1 = Menu programmable, 2 = Menu only visible)	R/W	<i>A.1.b.c.</i>	1
	H50	0050d (0032h)	Word	Alarm2 output menu, security parameter (0 = Menu invisible, 1 = Menu programmable, 2 = Menu only visible)	R/W	<i>A.2.b.c.</i>	1
	H51	0051d (0033h)	Word	Configuration menu, security parameter (0 = Menu invisible, 1 = Menu programmable, 2 = Menu only visible)	R/W	<i>C.o.b.c.</i>	1
H52	0052d (0034h)	Word	Self tune menu, security parameter (0 = Menu invisible, 1 = Self tune can be done)	R/W	<i>S.t.b.c.</i>	1	
H53	0053d (0035h)	Word	Profile configuration menu, security parameter (0 = Menu invisible, 1 = Menu programmable, 2 = Menu only visible)	R/W	<i>P.C.b.c.</i>	1	

1.2 Memory Map for Coils

Parameter Number	Coil Address	Data Type	Parameter Description	Read / Write Permission	Parameter Name	Default Value
C0	(0000)h	Bit	Alarm2 condition (0 = Active Low ,1 =Active High)	R/W	<i>A.2.b.t.</i>	1
C1	(0001)h	Bit	Alarm2 condition selection on probe failure (0 = Off , 1 = On)	R/W	<i>A.2.E.r.</i>	0
C2	(0002)h	Bit	Alarm1 condition (0 = Active Low ,1 =Active High)	R/W	<i>A.1.b.t.</i>	1
C3	(0003)h	Bit	Alarm1 condition selection on probe failure (0 = Off , 1 = On)	R/W	<i>A.1.E.r.</i>	0
C4	(0004)h	Bit	Control output configuration (0 = Heat ; 1 = Cool)	R/W	<i>C.t.Y.P.</i>	0
C5	(0005)h	Bit	Temperature unit (0 = °C ; 1 = °F)	R/W	<i>u.n.i.t.</i>	0
C6	(0006)h	Bit	Control outputs active (0 = Control outputs active, 1 = Only display mode)	R/W	<i>----</i>	0
C7	(0007)h	Bit	Controlling according to 2nd temperature setpoint (If C7 = 0 is H0, if C7 = 1 is H1)	R/W	<i>----</i>	0
C8	(0008)h	Bit	Auto/Manual selection (0 = Automatic "Running mode", 1 = Manual "Running mode". In this mode, output generated according to H39 parameter.)	R/W	<i>----</i>	0
C9	(0009)h	Bit	Control format in case of probe failure (0 = H10 proportional control according to percentage value, 1 = Error found before the setpoint control is done with the value of the proportional control)	R/W	<i>C.E.c.t.</i>	0

1.3 Memory Map for Input Registers

Parameter Number	Input Register Address Decimal (Hex)	Data Type	Parameter Description	Read / Write Permission
I0	0000d (0000h)	Word	Measured temperature	R
I1	0001d (0001h)	Word	Analog output percentage	R
I2	0002d (0002h)	Word	Measurement error codes 0 = No error, 1 = Sensor short circuit, 2 = Lower scale error, 3 = Upper scale error, 4 = Sensor connection lost, 5 = Wrong input selection.	R
I3	0003d (0003h)	Word	Self tune condition codes 0 = No error, 1 = Initial temperature is higher than 60% setpoint value, 2 = Calculating PID parameters, 3 = Calculating power set parameters	R
I4	0004d (0004h)	Word	Current (active) temperature setpoint.	R
I5	0005d (0005h)	Word	Reserved	R
I6	0006d (0006h)	Word	Current (active) decimal point value (0 = No decimal point, 1 = 0.0 Decimal point is tenths)	R

1.4 Memory Map for Discrete input

Parameter Number	Discrete Input Address	Data Type	Parameter Description	Read / Write Permission
D0	(0000)h	Bit	C/A2 Control output status (0 = OFF ,1 = ON)	R
D1	(0001)h	Bit	A1 Output status (0 = OFF , 1 = ON)	R
D2	(0002)h	Bit	SSR Output status (0 = OFF ,1 = ON)	R
D3	(0003)h	Bit	Digital input status (0 = OFF ,1 = ON)	R

END A EUPx420 SERIES PID TEMPERATURE CONTROLLER MODBUS PROTOCOL ADDRESS MAP

2.1 Memory Map for Profile Control Holding Registers

Parameter Number	Holding Register Address Decimal (Hex)	Data Type	Data Content	Read / Write Permission	Parameter Name	Default Value																																
PH0	0100d (0064h)	Word	Profile time base set value. (0 = 0000s, 1 = 00m59s, 2 = 0000m, 3 = 99m59s)	R/W	τ.P.S.	0																																
PH1	0101d (0065h)	Word	Maximum number of steps (can be adjusted between 0 and 16. If set to 0, runs on timer/thermostat mode)	R/W	Stufen	0																																
PH2	0102d (0066h)	Word	Target temperature difference for increasing the step. (It can be set between 0 and H3 parameter. If the step time is reached before the target temperature is reached when the profile is checked, then the difference between the target temperature and the measured temperature is expected to be less than or equal to this parameter value and then proceed to the next step. If the difference is smaller than or equal to this parameter, the timer is switched on. See Drawing-4 / page 4 on user manual).	R/W	ΔT.P.	0																																
PH38	0138d (008Ah)	Word	Display selection parameter: It can take between 1 and 10 values. When 1 is selected, only the process value is displayed. When 2 and up values are selected, the step number and the process value are displayed alternately if 2 or more step profiles are programmed. The entered number indicates the number of seconds to display the step number. For example, if 4 is entered, the step number is displayed for 1 second in 4 seconds.	R/W	dsEL.	0																																
PH3	0103d (0067h)	Word	1st-Step target temperature set value (can be adjusted between H2 and H3 parameter) If PH1 parameter set 0, temperature setpoint for Timer/Thermostat mode.	R/W	τ.E.01 CSet	200																																
PH4	0104d (0068h)	Word	1st-Time value can be set from 0 to 9999 seconds or minutes (changes with the depending on PH0 parameter). If PH1 parameter set 0, time setpoint for Timer/Thermostat mode.	R/W	τ.T.01 τ.inE	60																																
PH5	0105d (0069h)	Word	2nd-Step target temperature set value (can be adjusted between H2 and H3 parameter)	R/W	τ.E.02	200																																
PH6	0106d (006Ah)	Word	2nd-Time value can be set from 0 to 9999 seconds or minutes (changes with the depending on PH0 parameter).	R/W	τ.T.02	60																																
PH7	0107d (006Bh)	Word	3rd-Step target temperature set value (can be adjusted between H2 and H3 parameter)	R/W	τ.E.03	200																																
PH8	0108d (006Ch)	Word	3rd-Time value can be set from 0 to 9999 seconds or minutes (changes with the depending on PH0 parameter).	R/W	τ.T.03	60																																
PH9	0109d (006Dh)	Word	4th-Step target temperature set value (can be adjusted between H2 and H3 parameter)	R/W	τ.E.04	200																																
PH10	0110d (006Eh)	Word	4th-Time value can be set from 0 to 9999 seconds or minutes (changes with the depending on PH0 parameter).	R/W	τ.T.04	60																																
PH11	0111d (006Fh)	Word	5th-Step target temperature set value (can be adjusted between H2 and H3 parameter)	R/W	τ.E.05	200																																
PH12	0112d (0070h)	Word	5th-Time value can be set from 0 to 9999 seconds or minutes (changes with the depending on PH0 parameter).	R/W	τ.T.05	60																																
PH13	0113d (0071h)	Word	6th-Step target temperature set value (can be adjusted between H2 and H3 parameter)	R/W	τ.E.06	200																																
PH14	0114d (0072h)	Word	6th-Time value can be set from 0 to 9999 seconds or minutes (changes with the depending on PH0 parameter).	R/W	τ.T.06	60																																
PH15	0115d (0073h)	Word	7th-Step target temperature set value (can be adjusted between H2 and H3 parameter)	R/W	τ.E.07	200																																
PH16	0116d (0074h)	Word	7th-Time value can be set from 0 to 9999 seconds or minutes (changes with the depending on PH0 parameter).	R/W	τ.T.07	60																																
PH17	0117d (0075h)	Word	8th-Step target temperature set value (can be adjusted between H2 and H3 parameter)	R/W	τ.E.08	200																																
PH18	0118d (0076h)	Word	8th-Time value can be set from 0 to 9999 seconds or minutes (changes with the depending on PH0 parameter).	R/W	τ.T.08	60																																
PH19	0119d (0077h)	Word	9th-Step target temperature set value (can be adjusted between H2 and H3 parameter)	R/W	τ.E.09	200																																
PH20	0120d (0078h)	Word	9th-Time value can be set from 0 to 9999 seconds or minutes (changes with the depending on PH0 parameter).	R/W	τ.T.09	60																																
PH21	0121d (0079h)	Word	10th-Step target temperature set value (can be adjusted between H2 and H3 parameter)	R/W	τ.E.10	200																																
PH22	0122d (007Ah)	Word	10th-Time value can be set from 0 to 9999 seconds or minutes (changes with the depending on PH0 parameter).	R/W	τ.T.10	60																																
PH23	0123d (007Bh)	Word	11th-Step target temperature set value (can be adjusted between H2 and H3 parameter)	R/W	τ.E.11	200																																
PH24	0124d (007Ch)	Word	11th-Time value can be set from 0 to 9999 seconds or minutes (changes with the depending on PH0 parameter).	R/W	τ.T.11	60																																
PH25	0125d (007Dh)	Word	12th-Step target temperature set value (can be adjusted between H2 and H3 parameter)	R/W	τ.E.12	200																																
PH26	0126d (007Eh)	Word	12th-Time value can be set from 0 to 9999 seconds or minutes (changes with the depending on PH0 parameter).	R/W	τ.T.12	60																																
PH27	0127d (007Fh)	Word	13th-Step target temperature set value (can be adjusted between H2 and H3 parameter)	R/W	τ.E.13	200																																
PH28	0128d (0080h)	Word	13th-Time value can be set from 0 to 9999 seconds or minutes (changes with the depending on PH0 parameter).	R/W	τ.T.13	60																																
PH29	0129d (0081h)	Word	14th-Step target temperature set value (can be adjusted between H2 and H3 parameter)	R/W	τ.E.14	200																																
PH30	0130d (0082h)	Word	14th-Time value can be set from 0 to 9999 seconds or minutes (changes with the depending on PH0 parameter).	R/W	τ.T.14	60																																
PH31	0131d (0083h)	Word	15th-Step target temperature set value (can be adjusted between H2 and H3 parameter)	R/W	τ.E.15	200																																
PH32	0132d (0084h)	Word	15th-Time value can be set from 0 to 9999 seconds or minutes (changes with the depending on PH0 parameter).	R/W	τ.T.15	60																																
PH33	0133d (0085h)	Word	16th-Step target temperature set value (can be adjusted between H2 and H3 parameter)	R/W	τ.E.16	200																																
PH34	0134d (0086h)	Word	16th-Time value can be set from 0 to 9999 seconds or minutes (changes with the depending on PH0 parameter).	R/W	τ.T.16	60																																
PH35	0135d (0087h)	Word	AL1 Output control bits in steps. <table border="1" style="width: 100%; text-align: center;"> <tr> <td>B15</td><td>B14</td><td>B13</td><td>B12</td><td>B11</td><td>B10</td><td>B9</td><td>B8</td><td>B7</td><td>B6</td><td>B5</td><td>B4</td><td>B3</td><td>B2</td><td>B1</td><td>B0</td> </tr> <tr> <td>Step8</td><td>Step7</td><td>Step6</td><td>Step5</td><td>Step4</td><td>Step3</td><td>Step2</td><td>Step1</td><td>Step16</td><td>Step15</td><td>Step14</td><td>Step13</td><td>Step12</td><td>Step11</td><td>Step10</td><td>Step9</td> </tr> </table> AL1 Output will be activated when related step bits are set.	B15	B14	B13	B12	B11	B10	B9	B8	B7	B6	B5	B4	B3	B2	B1	B0	Step8	Step7	Step6	Step5	Step4	Step3	Step2	Step1	Step16	Step15	Step14	Step13	Step12	Step11	Step10	Step9	R/W	----	0
B15	B14	B13	B12	B11	B10	B9	B8	B7	B6	B5	B4	B3	B2	B1	B0																							
Step8	Step7	Step6	Step5	Step4	Step3	Step2	Step1	Step16	Step15	Step14	Step13	Step12	Step11	Step10	Step9																							
PH36	0136d (0088h)	Word	AL2 output control step bits. (Set such as PH35 parameter).	R/W	----	0																																
PH37	0137d (0089h)	Word	Step control parameter (holding registers of PC32-PC38 step control coils) <table border="1" style="width: 100%; text-align: center;"> <tr> <td>B15</td><td>B14</td><td>B13</td><td>B12</td><td>B11</td><td>B10</td><td>B9</td><td>B8</td><td>B7</td><td>B6</td><td>B5</td><td>B4</td><td>B3</td><td>B2</td><td>B1</td><td>B0</td> </tr> <tr> <td>—</td><td>PC38</td><td>PC37</td><td>PC36</td><td>PC35</td><td>PC34</td><td>PC33</td><td>PC32</td><td>—</td><td>—</td><td>—</td><td>—</td><td>—</td><td>—</td><td>—</td><td>—</td> </tr> </table> See chapter 2.2 coil descriptions for bit significations.	B15	B14	B13	B12	B11	B10	B9	B8	B7	B6	B5	B4	B3	B2	B1	B0	—	PC38	PC37	PC36	PC35	PC34	PC33	PC32	—	—	—	—	—	—	—	—	R/W	----	0
B15	B14	B13	B12	B11	B10	B9	B8	B7	B6	B5	B4	B3	B2	B1	B0																							
—	PC38	PC37	PC36	PC35	PC34	PC33	PC32	—	—	—	—	—	—	—	—																							

Step Control Parameters

ENDA EUPx420 SERIES PID TEMPERATURE CONTROLLER MODBUS PROTOCOL ADDRESS MAP

4. MODBUS ERROR MESSAGES

Modbus protocol has two types error, communication error and operating error. Reason of the communication error is data corruption in transmission. Parity and CRC control should be done to prevent communication error. Receiver side checks parity and CRC of the data. If they are wrong, the message will be ignored. If format of the data is true but function doesn't perform for any reason, operating error occurs. Slave realizes error and sends error message. Most significant bit of function is changed '1' to indicate error in error message by slave. Error code is sent in data section. Master realizes error type via this message.

ModBus Error Codes

Error Code	Name	Meaning
01	ILLEGAL FUNCTION	The function code received in the query is not an allowable action for the slave. If a Poll Program Complete command was issued, this code indicates that no program function preceded it.
02	ILLEGAL DATA ADDRESS	The data address received in the query is not an allowable address for the slave.
03	ILLEGAL DATA VALUE	A value contained in the query data field is not an allowable value for the slave.

Message sample :

Structure of command message (Byte Format)

Device Address		(0A)h
Function Code		(01)h
Beginning address of coils.	MSB	(04)h
	LSB	(A1)h
Number of coils (N)	MSB	(00)h
	LSB	(01)h
CRC DATA	LSB	(AC)h
	MSB	(63)h

Structure of response message (Byte Format)

Device Address		(0A)h
Function Code		(81)h
Error Code		(02)h
CRC DATA	LSB	(B0)h
	MSB	(53)h

As you see in command message, coil information of (4A1)h = 1185 is required but there isn't any coil with 1185 address. Therefore error code with number (02) (Illegal Data Address) sends.

