

VMA02

MANUAL HVMA02'1

Audio shield for Arduino®

velleman®
MODULES

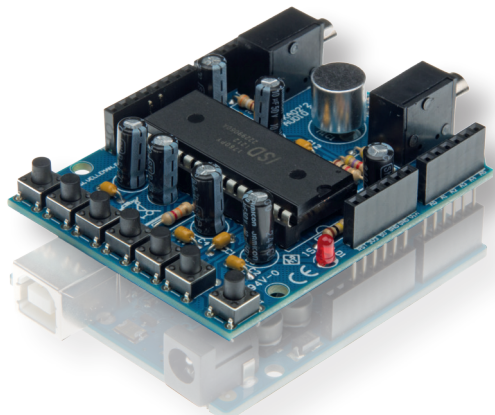

Record your voice via a built-in microphone or a line input.

Features

- For use with Arduino Due™, Arduino Uno™, Arduino Mega™
- Based on ISD1760PY integrated circuit
- With pushbuttons for REC, PLAY, FWD, ERASE, VOL, RESET and FEEDTROUGH
- Built-in microphone
- 3.5mm stereo LINE IN/OUT female jacks
- Speaker output

Specifications

- Recording time: 60s
- Power supply: from Arduino™
- Dimensions: 71 x 53mm / 2.79 x 2.08"





Participate our Velleman Projects Forum

1 PUSH - BUTTONS



2 SPEAKER
4 - 8 ohm



3.5mm STEREO JACK

3 LINE OUT

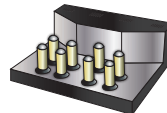

4 ICSP CONNECTOR

5 MICROPHONE

6 LINE IN



7 FUNCTION INDICATOR

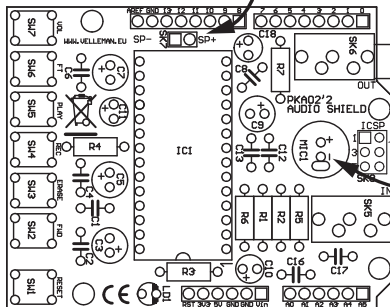

DOWNLOAD SAMPLE CODE FROM KA02 PAGE ON WWW.VELLEMAN.BE

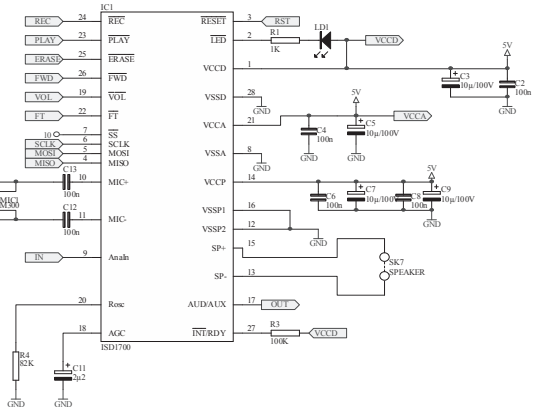
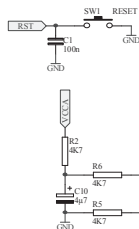
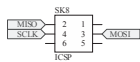
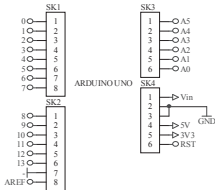
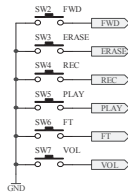
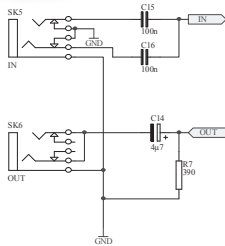



The new Velleman Projects catalogue is
now available. Download your copy here:
www.vellemanprojects.eu



5 4 10329 555849

Modifications and typographical errors reserved - © Velleman nv. HVMA02
Velleman NV, Legen Heirweg 33 - 9890 Gavere.