



VM167 Getting started Installation guide



Getting started

Installation guide

Table of Contents

(I) First time plug in	3
(II) Hardware installation	5
(III) Windows 7 (32/64 bit)	9
(IV) General information	13
(1) DLL installing	13
(2) VM167 demo application	14
(3) Developing your own software	15
(4) Technical Support	16
(V) Connection examples	18
(1) button matrix (4 x 4) connected to four digital outputs and to four digital inputs.	18
(2) Single button connected between digital output and digital input	19
(3) Single button connected between external +5V and digital input	20
(4) VM167 connected to the relay card K6714-16	21
(5) Circuit diagram of a PWM to analog converter	22

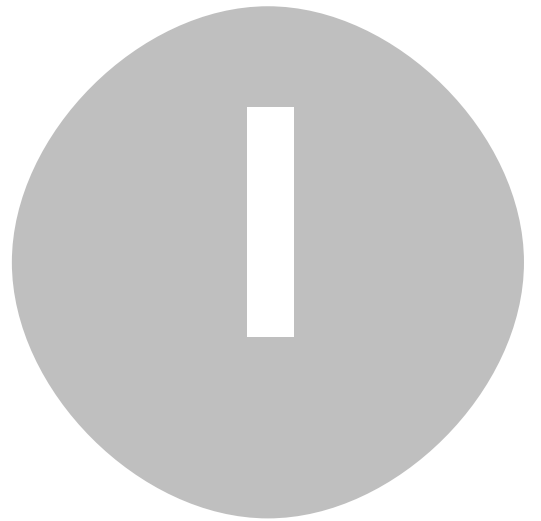

Plugging in your board for the first time

First, you will need to plug your VM167 into an available USB (1.1/2.0) port on your computer so Windows can detect this new device.

Follow the instructions to install the hardware driver.

Step-by-step screenshot images for following operating systems are included here for Windows XP and Windows 7.

Note that you need administrative privileges to install new hardware.

Note: If you are using the Velleman K8061 or VM140 USB board in the same PC with the VM167, you have to install the driver from the folder **\\VM167DriverWinUSB**.

Also if you encounter any problems with the driver installed from the folder **\\VM167Driver**, you can remove this driver and install the driver from the folder **\\VM167DriverWinUSB**.

Note: Only the driver from the folder \\VM167Driver is usable with Windows 2000.



Hardware Installation

Windows 2000/XP(32/64 bit)

After you've plugged in your device you should be prompted with the Windows *'Found New Hardware Wizard'*.

If the wizard did not open, you can open it manually through the following steps:

- Click **Start -> Run..**
- Type **devmgmt.msc** and press **OK**
- Search for a 'VM167 USB Interface Board' entry under the *Other devices* category
- Right-click the entry and click **Update Driver..**

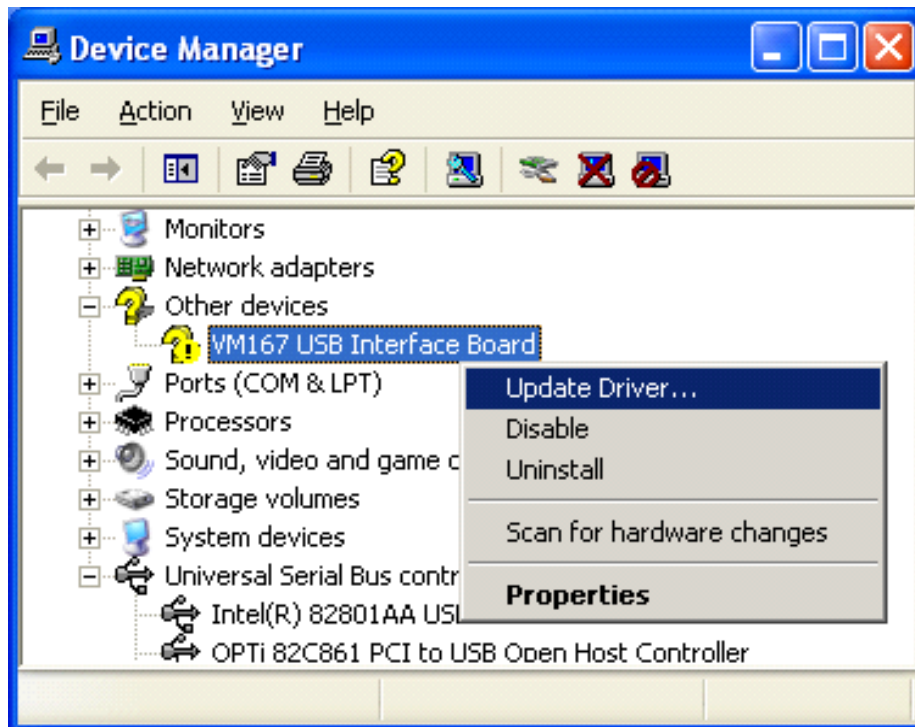

You should now be prompted with the **'Hardware Update Wizard'**.



Select 'No, not this time' and click 'Next' to continue.

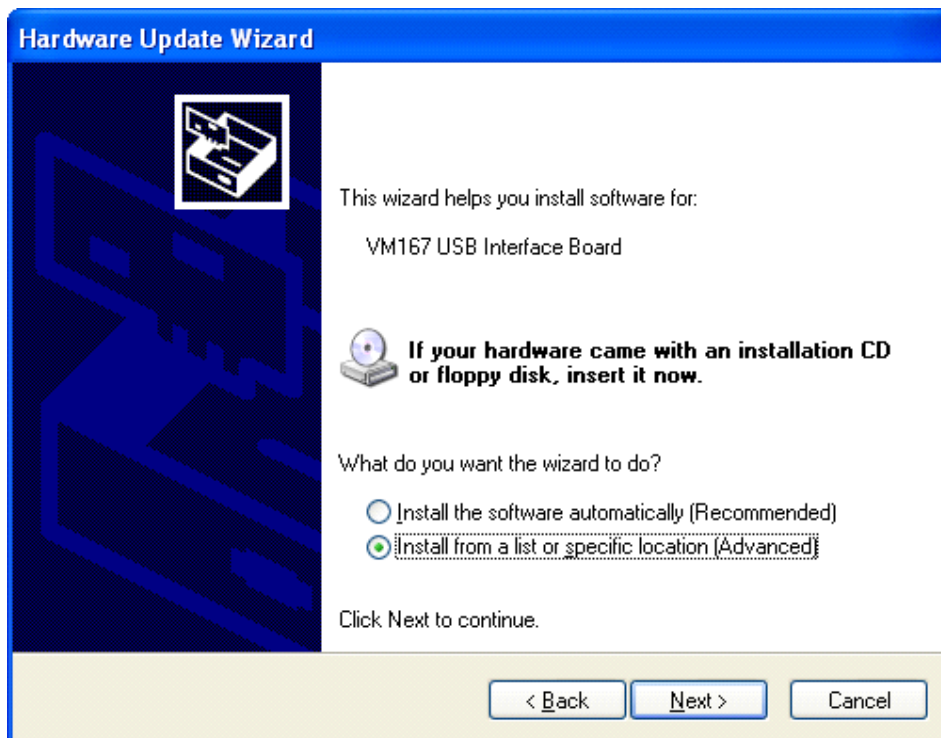

Then select 'Install from a list or specific location (Advanced)'. Click 'Next' to continue.

You will be asked for the location of your driver files. Complete the dialog as indicated below.

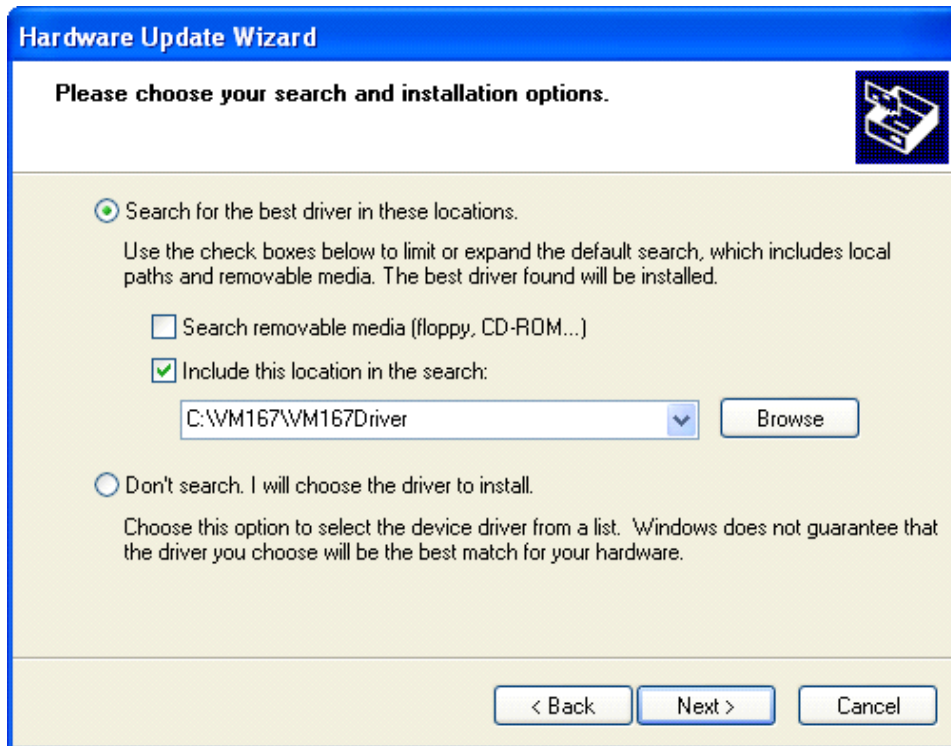

Under '**Include this location in the search**', enter the location of the driver files or use '**Browse**' to locate the VM167Driver folder. Click '**Next**' to continue.

If you receive a warning, click '**Continue Anyway**'. This cannot harm your computer since it is safe to use the VM167 driver. Make sure you downloaded the driver or installation package from the Velleman website. Installation should now be complete. You are ready to use the board.

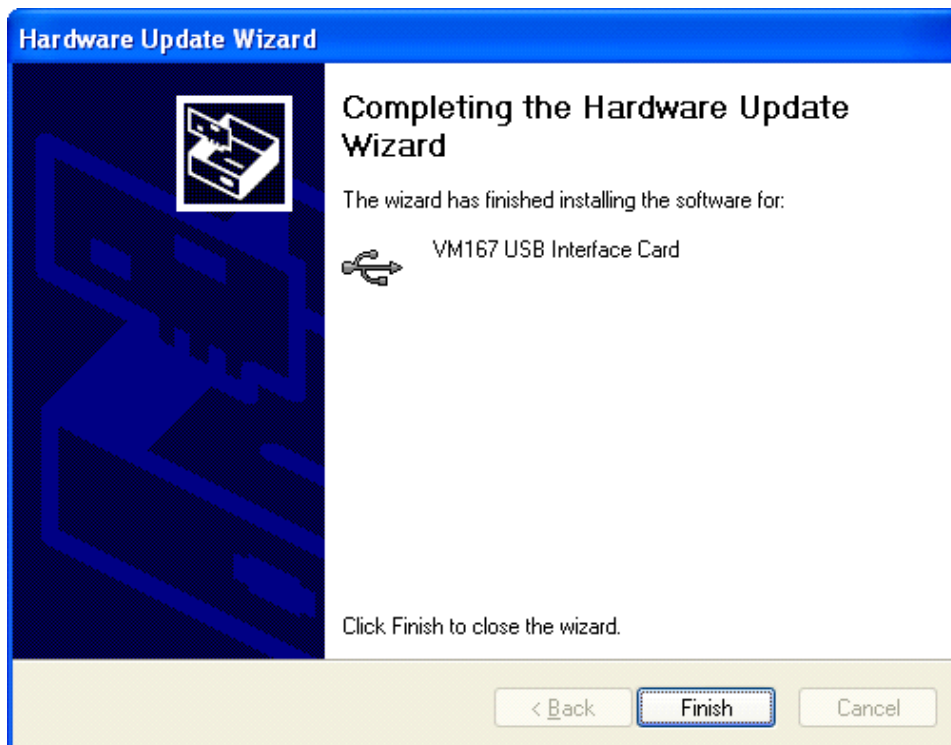

Continue to the chapter Running the VM167 Demo application to continue.



Windows 7 (32/64 bit)

After you've plugged in your device you should be prompted with the Windows *'Found New Hardware Wizard'*.

If the wizard did not open, you can open it manually through the following steps:

- Press the **Windows key + R**
- Type **devmgmt.msc** and press **OK**
- Search for a 'VM167 USB Interface Board' entry under the *Other devices* category
- Right-click the entry and click **Update Driver Software...**

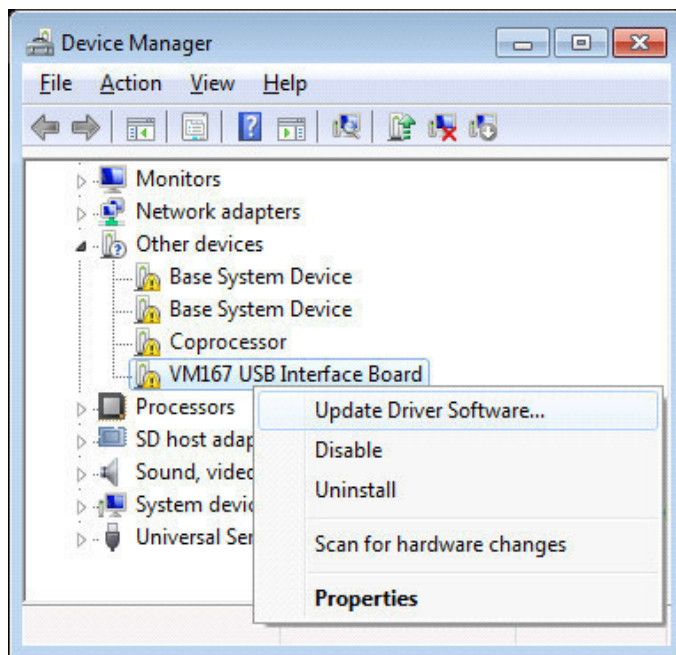

You should now be prompted with the **'Update Driver Software'** dialog.



Select **'Browse my computer for driver software'**.

You will be asked for the location of your driver files. Use **Browse** to locate the driver file folder.



Click **'Next'** to continue.

When you receive this warning, click **'Install this driver software anyway'**. This cannot harm your computer since it is safe to use our driver. Make sure you downloaded the driver or installation package from the Velleman website.

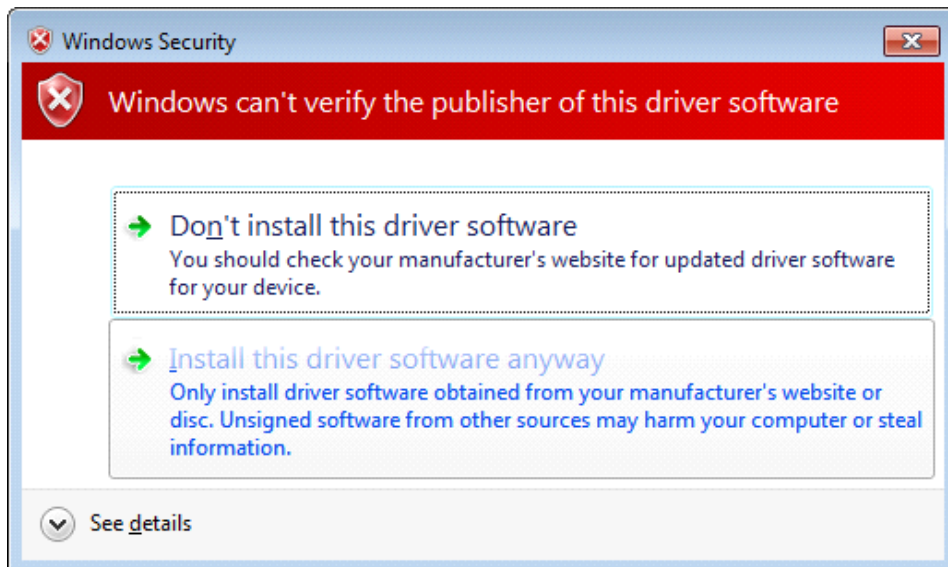

Installation should now be complete. You are ready to use the board.

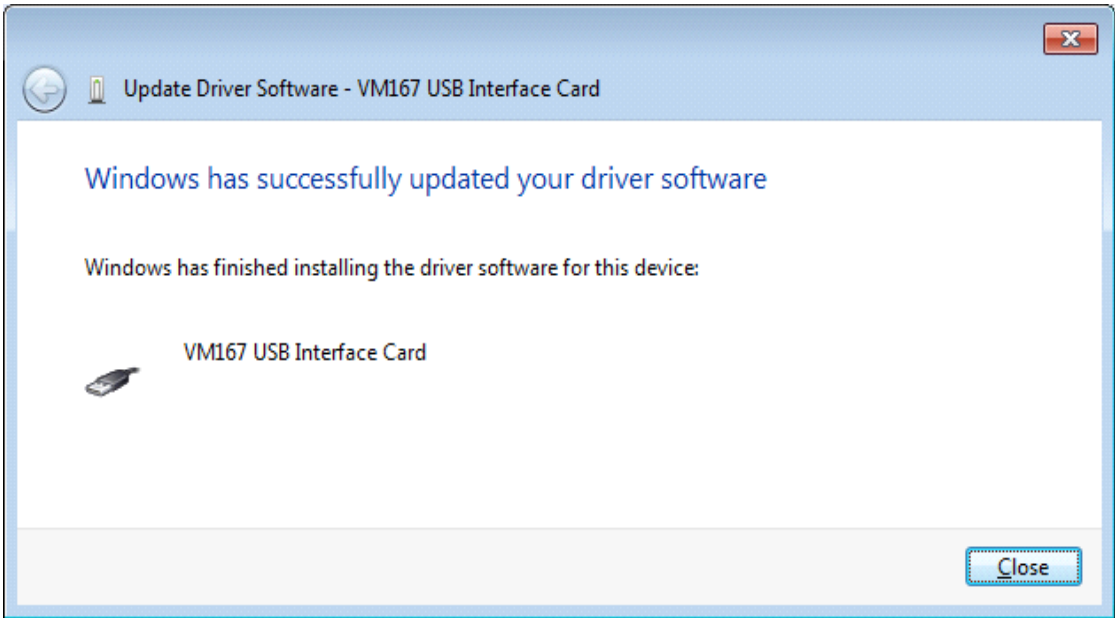



Installing the VM167.DLL and MPUSBAPI.DLL

The files **VM167.DLL** and **MPUSBAPI.DLL** from the folder \DLL have to be copied to the Windows' System32 folder. In 64-bit environment the files must be copied to Windows' SysWOW64 folder. Alternatively you may run the **DLLsetup.exe** to copy the files to the right folder.



VM167.DLL technical guide

Running the VM167 Demo application

This software package contains ready to use standalone demo application to be able to test your board. The demo application is located in the **\Demo** folder of the software package.

Developing your own software

The VM167 USB Interface Board comes with a library (DLL) that can be used to communicate with the board in any programming language. The VM167 software package includes examples on how to use this DLL in some of the most popular programming languages. At this time the following programming languages / environments are supported:

- Microsoft Visual Basic 2008 Express Edition
- Microsoft Visual C++ 2008 Express Edition
- Microsoft Visual C# 2008 Express Edition
- Microsoft Visual Basic 6.0
- Microsoft Excel VBA
- Borland Delphi 5
- Borland C++Builder 6 (static DLL load and dynamic DLL load examples)
- Bloodshed Dev-C++

Technical Support

Velleman Projects Service Forum

In case you have a question or problem with the VM167 board, you can visit our online forum for help. This forum is frequented by employees here at Velleman and other Velleman Projects enthusiasts. To visit the forum enter the following URL in your browser:
<http://forum.velleman.be/>



Button matrix (4 x 4) connected to four digital outputs and to four digital inputs.

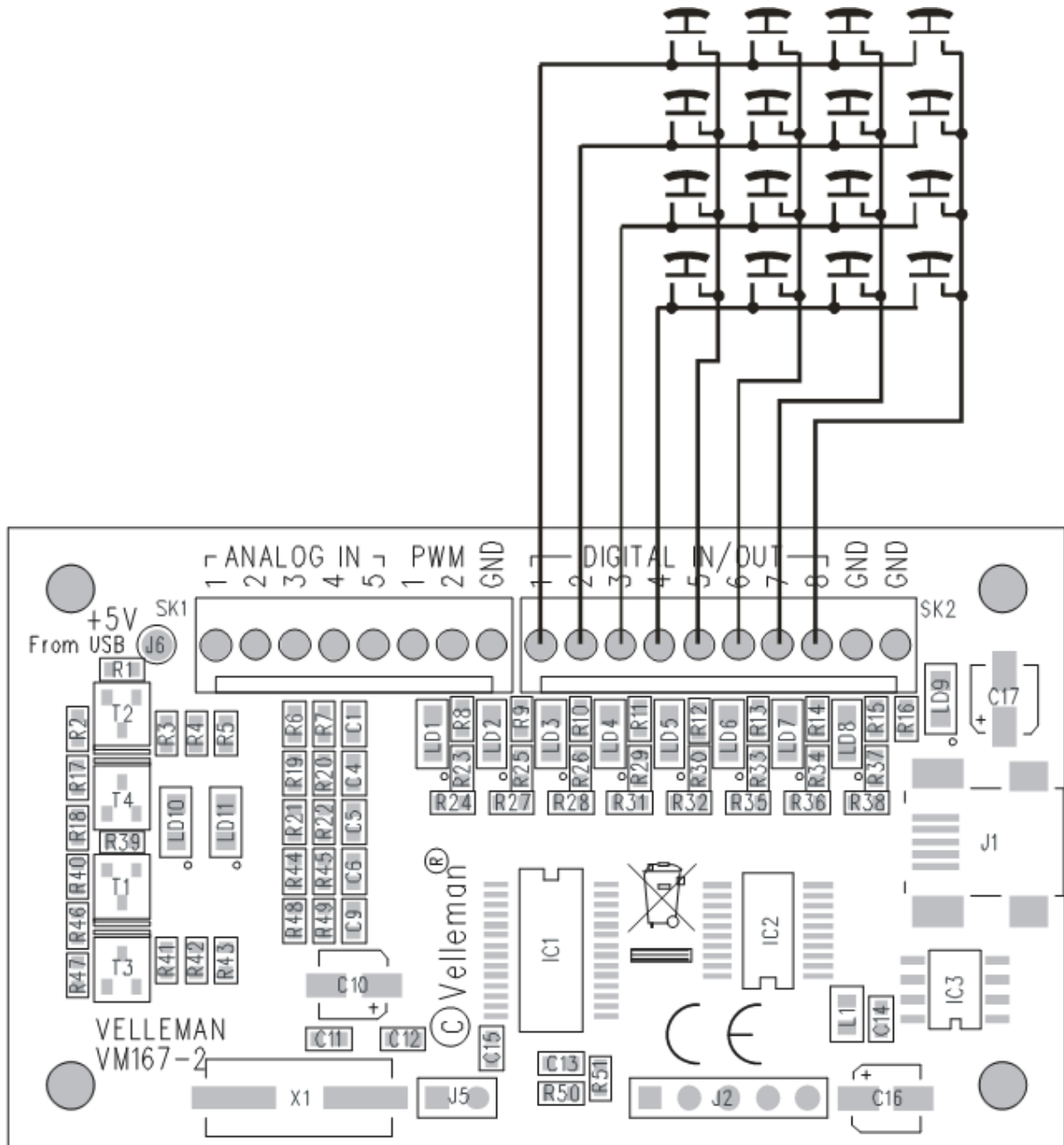

Single button connected between digital output and digital input

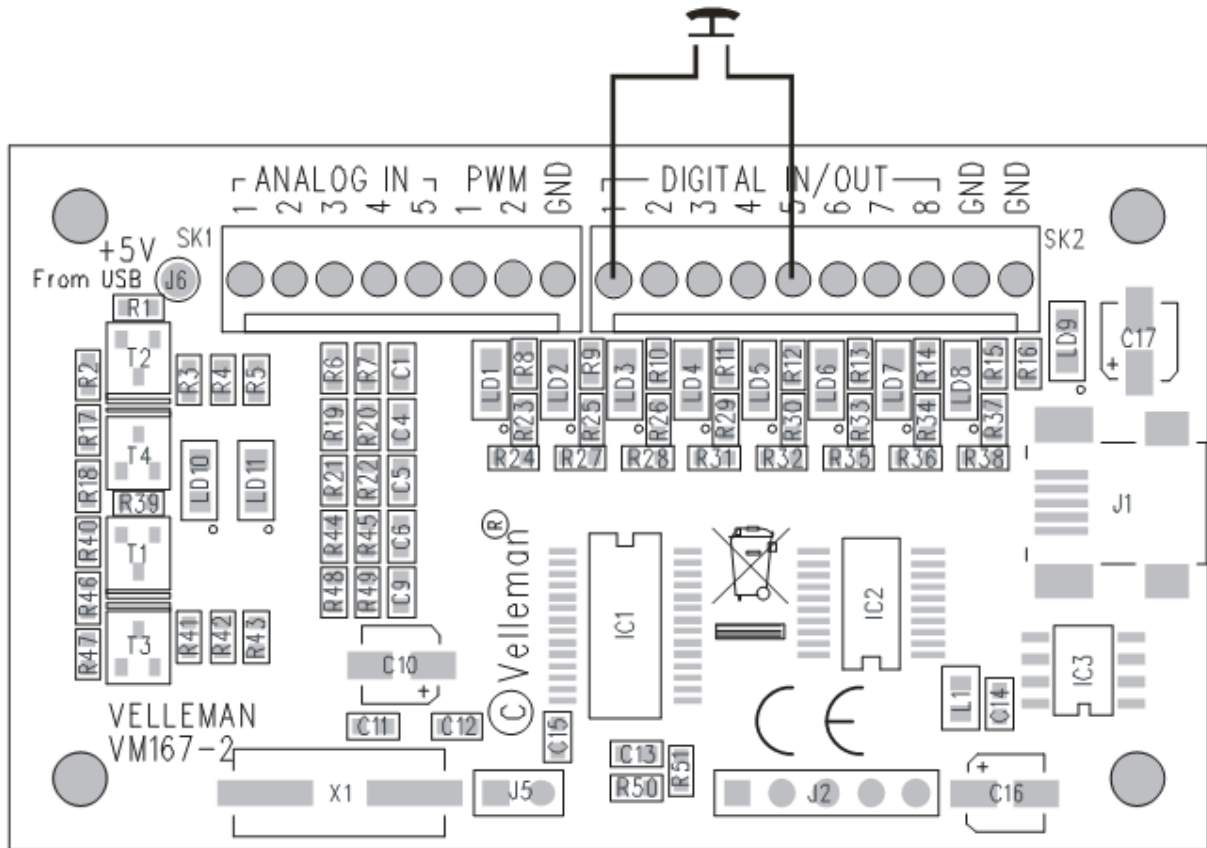

Single button connected between external +5V and digital input

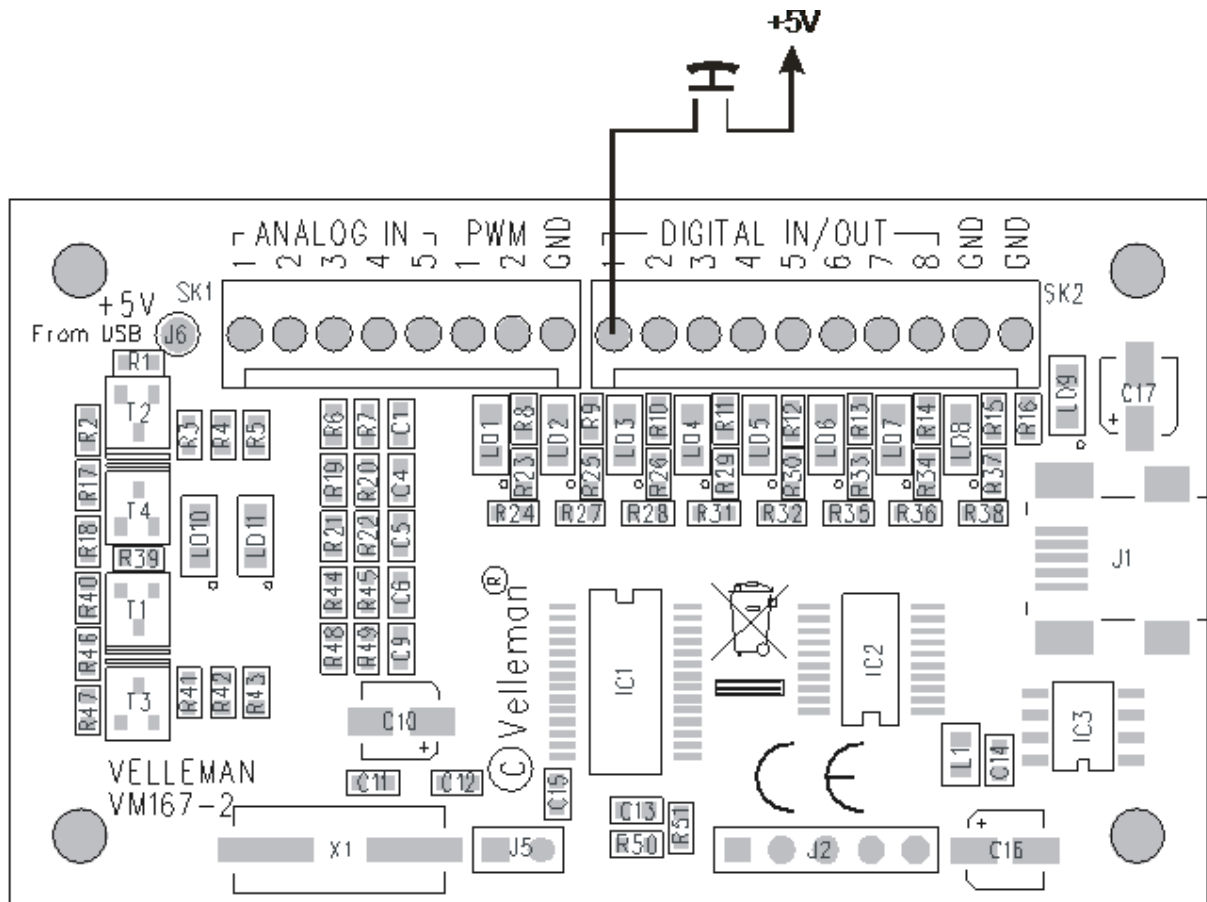

VM167 connected to the relay card K6714-16.
 IC1 and IC2 must be placed to the K6714-16 card.

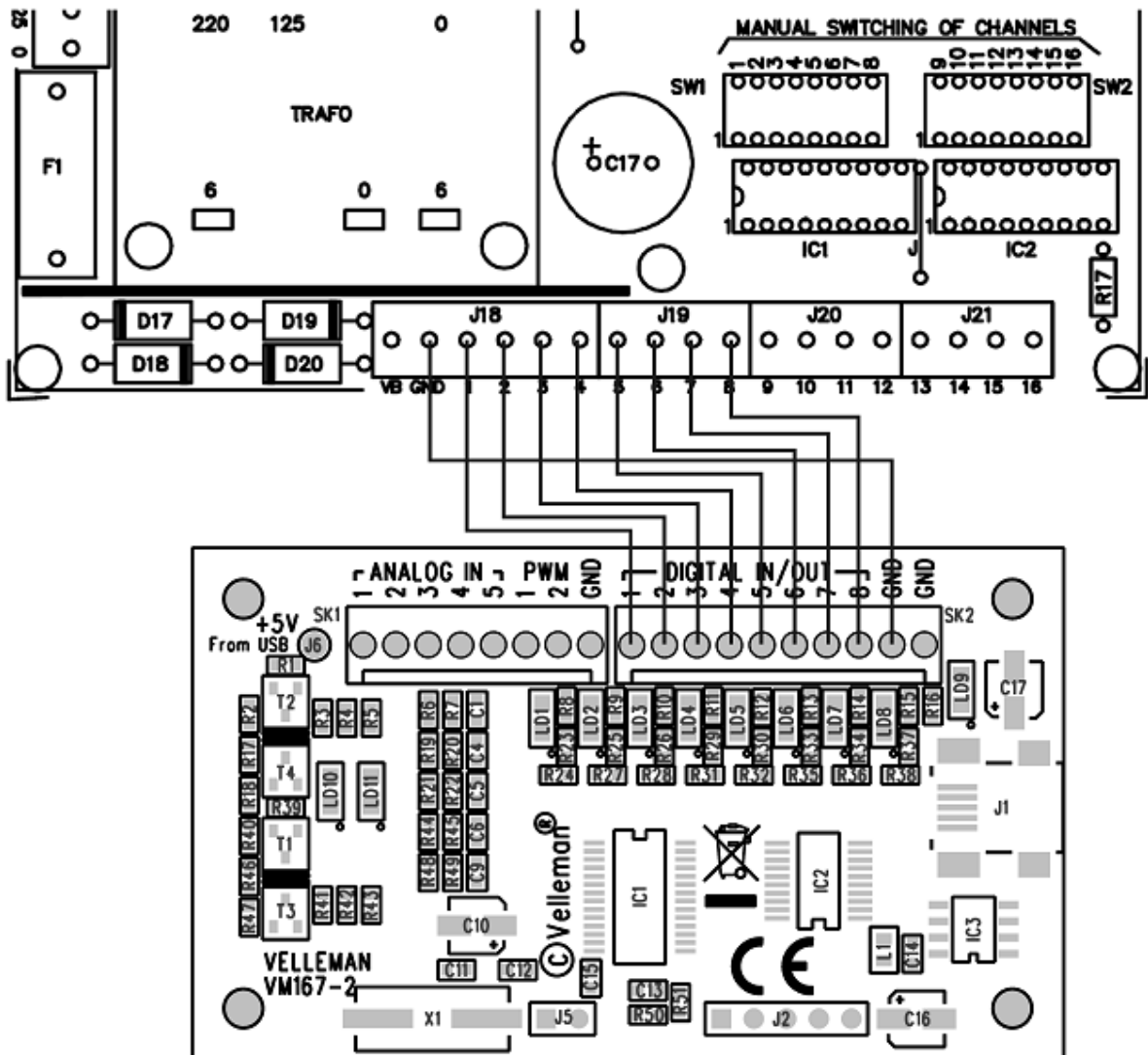

Circuit diagram of a PWM to analog converter

