

10

PC tab

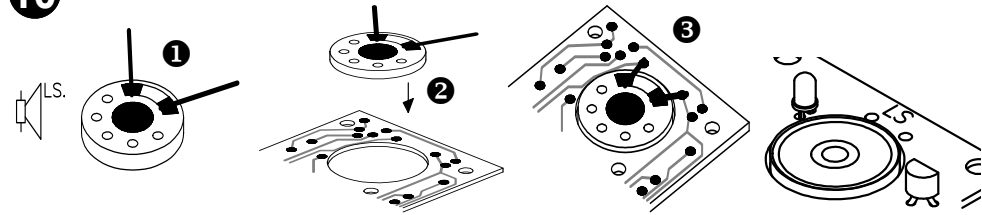

START

1

Resistor - Weerstand - Résistance - Widerstand - Resistencia - Motstand - Vastus - Resistenze

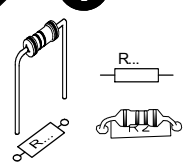

- ◇ R1, R2 : 1M (Brown, Black, Green) - (Bruin, zwart, Groen) - (Brun, noir, Vert) - (Braun, Schwarz, Grün) - (Brun, Svart, Grön) - (Ruskea, Musta, Vihreä) - (Marrón, Negro, Morado) - (Castanho, Preto, Verde) - (Marrone, Nero, Verde)
- ◇ R3, R4 : 100K (Brown, Black, Yellow) - (Bruin, zwart, Geel) - (Brun, noir, Jaune) - (Braun, Schwarz, Gelb) - (Brun, Svart, Gul) - (Ruskea, Musta, Keltainen) - (Marrón, Negro, Amarillo) - (Castanho, Preto, Amarelo) - (Marrone, Nero, Giallo)
- ◇ R5 : 1K (Brown, Black, Red) - (Bruin, zwart, Rood) - (Brun, Noir, Rouge) - (Braun, Schwarz, Rot) - (Brun, Svart, Röd) - (Ruskea, Musta, Punainen) - (Marrón, Negro, Rojo) - (Castanho, Preto, Encarnado) - (Marrone, Nero, Rosso)
- ◇ R6 : 220 (Red, Red, Brown) - (Rood, Rood, Bruin) - (Rouge, Rouge, Brun) - (Rot, Rot, Braun) - (Röd, Röd, Brun) - (Punainen, Punainen, Ruskea) - (Rojo, Rojo, Marrón) - (Encarnado, Encarnado, Castanho) - (Rosso, Rosso, Marrone)

11

Switch

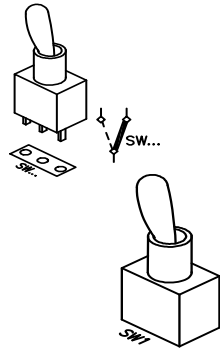

12

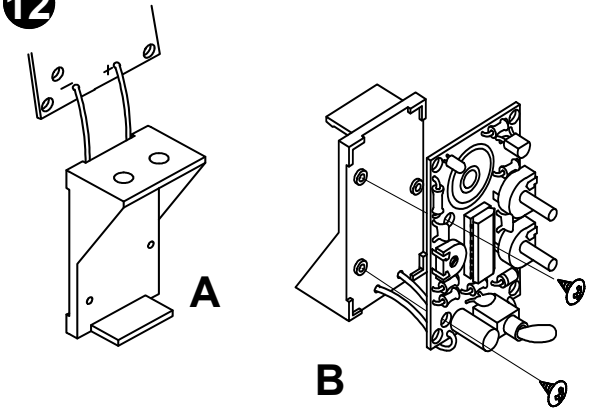

MK106_rev.2

2

Diode

Watch the polarity !
Attention à la polarité !

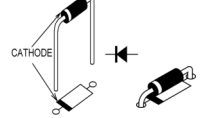

◇ D1 : 1N4007

3

IC socket

WATCH THE POSITION OF THE NOTCH !
ATTENTION A LA POSITION DE L'ENCOCHE !

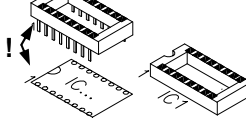

◇ IC1 : 16p

4

Transistor

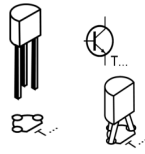

◇ T1 : BC517

5

Capacitor

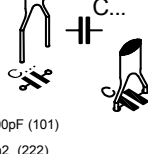

◇ C1 : 100pF (101)
◇ C2 : 2n2 (222)
◇ C3 : 1µF (105)

6

Electrolytic capacitor

WATCH THE POLARITY !
ATTENTION A LA POLARITE !

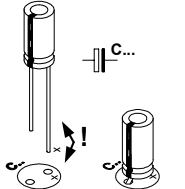

◇ C4 : 100µF

7

LED

Watch the polarity !
Att. la polarité !

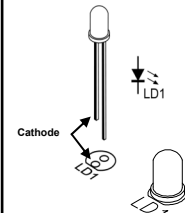

◇ LD1 : 3mm (red)

8

Trimmer

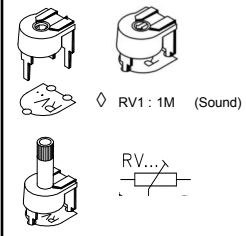

◇ RV1 : 1M (Sound)
◇ RV2 : 1M (BEATS/MIN)
◇ RV3 : 100 (VOLUME)

9

IC

WATCH THE POSITION OF THE NOTCH !
ATTENTION A LA POSITION DE L'ENCOCHE !

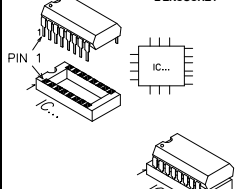

◇ IC1 : CD4049

